

AGENDA



ARCHITECTURAL REVIEW BOARD MEETING

CITY HALL, 385 SOUTH GOLIAD STREET, ROCKWALL, TEXAS

DECEMBER 27, 2023 IN THE CITY COUNCIL CONFERENCE ROOM AT 5:00 PM

NOTES ABOUT PUBLIC PARTICIPATION = **RED**

(I) CALL TO ORDER

(II) OPEN FORUM

This is a time for anyone to address the Architectural Review Board (ARB) on any topic. Per the policies of the City of Rockwall, public comments are limited to three (3) minutes out of respect for the time of other citizens. On topics raised during the OPEN FORUM, please know that the Architectural Review Board (ARB) is not permitted to respond to your comments during the meeting per the Texas Open Meetings Act.

(III) ACTION AGENDA

(1) **SP2023-047 (HENRY LEE)**

Discuss and consider a request by Nick Hobbs of BGE, Inc. on behalf of Ben Scott of HEB, LP for the approval of a Site Plan for Grocery Store (i.e. HEB) on a 12.519-acre tract of land identified as Tracts 2 & 3 of the J. M. Allen Survey, Abstract No. 2, City of Rockwall, Rockwall County, Texas, zoned Commercial (C) District, situated within the SH-205 By-Pass Overlay (SH-205 BY-OV) District and the IH-30 Overlay (IH-30 OV) District, located at the southwest corner of the eastbound IH-30 Frontage Road and John King Boulevard, and take any action necessary.

(2) **SP2023-048 (HENRY LEE)**

Discuss and consider a request by Leslie Ford of Ofi Chito on behalf of Michael Hampton of Creekside Commons Crossing, LP for the approval of a Site Plan for a Restaurant, Greater than 2,000 SF, with Drive-Through or Drive-In (i.e. McDonald's) on a 1.251-acre tract of land identified as a portion of Lot 3 and all of Lot 2, Block A, Creekside Commons Addition, City of Rockwall, Rockwall County, Texas, zoned Commercial (C) District, situated within the SH-205 Overlay (SH-205 OV) District, generally located north of the northeast corner of the intersection of S. Goliad Street [SH-205] and FM-549, and take any action necessary.

(3) **SP2023-049 (ANGELICA GUEVARA)**

Discuss and consider a request by Dewayne Zinn of Cross Engineering Consultants, Inc. on behalf of Chad Dubose of JCDB Goliad Holdings, LLC for the approval of a Site Plan for General Retail Building on a 0.7621-acre portion of a larger 2.542-acre parcel of land identified as Lot 1, Block A, Pecan Valley Retail Addition, City of Rockwall, Rockwall County, Texas, zoned Planned Development District 65 (PD-65) for General Retail (GR) District, situated within the North SH-205 Overlay (N. SH-205 OV) District, addressed as 150 Pecan Valley Drive, and take any action necessary.

(4) **SP2023-050 (HENRY LEE)**

Discuss and consider a request by Jeff Carroll of Carroll Architects on behalf of Scott Tharp of Scott Free Investments for the approval of a Site Plan for Office/Warehouse Buildings on a 3.90-acre tract of land identified as Tracts 2-23 & 2-24 of the J. R. Johnson Survey, Abstract No. 128, City of Rockwall, Rockwall County, Texas, zoned Heavy Commercial (HC) District, located at the southeast corner of the intersection of Mims Road and National Drive, and take any action necessary.

(IV) ADJOURNMENT

The City of Rockwall Planning and Zoning Commission reserves the right to adjourn into executive session at any time to discuss any matters listed on the agenda above, as authorized by Texas Government Code §551.071 (Consultation with City Attorney).

This facility is wheelchair accessible and accessible parking spaces are available. Request for accommodations or interpretive services must be made 48 hours prior to this meeting. Please contact the City Secretary's Office at (972) 772-6406 for further information.

I, Melanie Zavala, Planning and Zoning Coordinator for the City of Rockwall, Texas, do hereby certify that this Agenda was posted at City Hall, in a place readily accessible to the general public at all times, on December 22, 2023 prior to 5:00 PM, and remained so posted for at least 72 continuous hours preceding the scheduled time of said meeting.

SP2023-047: Site Plan for HEB

Please address the following comments (*M= Mandatory Comments; I = Informational Comments*)

- I.1 This is a request for the approval of a Site Plan for a *Grocery Store (i.e. HEB)* on a 12.519-acre tract of land identified as Tracts 2 & 3 of the J. M. Allen Survey, Abstract No. 2, City of Rockwall, Rockwall County, Texas, zoned Commercial (C) District, situated within the SH-205 By-Pass Overlay (SH-205 BY-OV) District and the IH-30 Overlay (IH-30 OV) District, located at the southwest corner of the eastbound IH-30 Frontage Road and John King Boulevard.
- I.2 For questions or comments concerning this case please contact Henry Lee in the Planning Department at (972) 772-6434 or email hlee@rockwall.com.
- M.3 For reference, include the case number (*SP2023-047*) in the lower right-hand corner of all pages of all revised plan submittals. (*Subsection 01.02(D), Article 11, Unified Development Code [UDC]*)
- I.4 The subject property will be required to plat to establish the new easements (*e.g. fire lane or utility easements*). (*Subsection 03.04. A, of Article 11, UDC*)
- M.5 A *Material Sample Board* must be provided by the December 27, 2023 Architecture Review Board (ARB) meeting. (*Subsection 03.04. A, of Article 11, UDC*)
- M.6 Provide the standard signature block with signature space for the Planning and Zoning Chairman and the Planning Director on all pages of the plans. Also remove the red placeholder text from the signature block. (*Subsection 03.04. A, of Article 11, UDC*)

APPROVED:

I hereby certify that the above and foregoing site plan for a development in the City of Rockwall, Texas, was approved by the Planning & Zoning Commission of the City of Rockwall on the ____ day of _____, _____.

WITNESS OUR HANDS, this ____ day of _____, _____.

Planning & Zoning Commission, Chairman

Director of Planning and Zoning

M.7 Site Plan:

- (1) Please indicate the distance between all property lines and existing and planned buildings located on the site. (*Subsection 03.04. B, of Article 11, UDC*)
- (2) Please only indicate the building setback adjacent to right-of-way (*i.e. IH-30 Frontage Road and S. John King Boulevard*). In addition, the building setback along John King is 25-feet due to property being located in the SH-205 Bypass Overlay. (*Subsection 03.04. B, of Article 11, UDC*)
- (3) Please remove the contours from the site plan. (*Subsection 03.04. B, of Article 11, UDC*)
- (4) Is there any proposed covered parking? If so, please delineate it on the site plan, and provide a detail. As a note, the coverings are required to meet the building setbacks (*i.e. 10-feet on the side*) and building separation requirements (*i.e. 15-feet*). (*Subsection 07.03, of Article 05, UDC*)
- (5) Please indicate the type and depth of the paving material and provide a detail or cut-sheet. All required parking and loading areas shall be constructed of concrete, but may have a surface treatment of brick, stone or other similar material. (*Subsection 03.02, of Article 06, UDC*)
- (6) Within the *General Overlay District Standards*, it stipulates that only one (1) row of parking may be located between the building and roadway. In this case, this will be an Exception. (*Subsection 06.02, of Article 05, UDC*)
- (7) Please remove all signage from the site plan. These will be handled through a separate permit process. (*Subsection 06.02. F, of Article 05, UDC*)
- (8) Is there any proposed fencing or gates? If so, please delineate them, indicate their material and height, and provide a detail. (*Subsection 08.02. F, of Article 08, UDC*)
- (9) Please indicate any pad mounted utility equipment (*if applicable*); this includes transformers. In addition, please indicate their subsequent screening on the landscape plan (*i.e. 5-gallon evergreen shrubs*). (*Subsection 01.05. C, of Article 05, UDC*)
- (10) Please provide a note if there will be any above ground storage tanks. (*Subsection 01.05. D, of Article 05, UDC*)

- (11) Please clarify if the dumpsters will be located within the building or within a detached dumpster enclosure. If they will be located within an enclosure please indicate it on the plans and provide a dumpster enclosure that meets the following requirements. Trash/Recycling enclosures shall be four (4) sided. These receptacles shall be screened by a minimum eight (8) foot, solid masonry dumpster enclosure that utilizes the same masonry materials as the primary building and incorporates an opaque, self-latching gate. Dumpster storage should be located to the rear of the buildings with proper access. Trash dumpster shall not be located in any required parking space and shall allow proper access by service trucks. The minimum enclosure area shall be 12'x10'. A minimum of 6" bollards will be required at potential impact zones and the pad site shall be paved to city standards. (*Subsection 01.05. B, of Article 05, UDC*)
- (12) Please provide a note that there will be no outside storage. Outside storage is not permitted within the IH-30 Overlay District. It should be noted that outside storage would include pallets, any merchandise, or equipment (*i.e. this includes vehicles*). (*Subsection 06.02, of Article 05, UDC*)
- (13) Please indicate the 50-foot residential adjacency buffer located along the south property line. The standard residential adjacency buffer is 20-foot; however, the Unified Development Code (UDC) increases this requirement to 50-feet for buildings that are greater than 50,000 SF in size (*Subsection 04.01. E, of Article 05, UDC*). In addition, please indicate the screening method. Per the Unified Development Code (UDC) the screening for the 20-foot buffer is either, (1) a masonry screening wall with canopy trees on 20-foot centers, or (2) three (3) tiered landscape screening (*i.e. a row of canopy trees, a row of accent trees, and a row of evergreen shrubs*); for the 50-foot buffer, evergreen shrubs and a berm is required. In this case, you are requesting a hybrid between the two (2). The Planning and Zoning has the authority to approve alternative screening plans, which is what this would be considered. That being said, the buffer must be 50-feet, and there is a point where this fall short. In addition, buffers are not allowed to have paving within them. Given this, there will be an Exception. In conclusion, (1) the buffer must be shown as 50-feet, (2) the alternative screening can be approved by the Planning and Zoning Commission, and (3) there is an exception due to there being paving in the buffer and the small portion that is under 50-feet. (*Subsection 01.06, of Article 05, UDC*)
- (14) Within the landscape plan set, please update the title of the sheet for "Rear Screening Detail" to "Residential Adjacency Detail." Staff wants to ensure clarity over what the detail is showing. (*Subsection 06.02, of Article 05, UDC*)
- (15) Please delineate any areas that will have incidental display/outside display. The incidental display must meet the requirements outlined in Subsection 02.03(F)(6), of Article 04, UDC. (*Subsection 02.03, of Article 04, UDC*)
- (16) Please provide staff with an Adaptive Reuse Plan. Adaptive Reuse Plans are required for buildings over 80,000 SF in size. The UDC states that the "applicant must demonstrate that the building can be subdivided in a reasonable manner by submitting a plan indicating potential entrances and exits and loading areas for multiple tenants." Simply provide staff with a plan that shows how the building may be subdivide utilizing the entrances and exits on the proposed building. (*Subsection 04.01 (E)(6), of Article 05, UDC*)

M.8 Landscape Plan:

- (1) Provide the same site data information required in Section 2.1 *Site Plan: Miscellaneous and Density and Dimensional Requirements* of the checklist. (*See Sec. 2.1 of the Site Plan Checklist*)
- (2) As indicated on the landscape plan, the landscape percentage requirement for a property located in a Commercial (C) District is 20%. In this case, you are providing less than 20%. This will be an Exception. (*Subsection 01.01. B, of Article 05, UDC*)
- (3) All canopy trees must be 4-inch caliper. Please correct the landscape table to reflect this. (*Subsection 05.03. B, of Article 08, UDC*)
- (4) All parking spaces are required to located within 80-feet of a canopy tree. In this case, the parking adjacent to the building does not meet this requirement. This will be an Exception. (*Subsection 05.03. E, of Article 08, UDC*)
- (5) The IH-30 Overlay District and the SH-205 Bypass Overlay District requires a berm, a row of shrubs, and two (2) canopy trees and four (4) accent trees per 100-feet of frontage. In this case, please show the berm within the landscape buffers. In addition, the buffer along IH-30 needs one (1) more canopy tree and one (1) more accent tree (*i.e. 519.8-feet / 100-feet = 5.19; 5.19 x 2 = 11 canopy trees; 5.19 x 4 =21*); and, the buffer along John King needs seven (7) more accent trees (*i.e. I only counted 33 accent trees within the buffer*).
- (6) Please extend the heavy landscaping at the southeast drive north, so that the loading docks are entirely screened from John King Boulevard. (*Subsection 05.02, of Article 08, UDC*)
- (7) Please indicate the 50-foot residential adjacency buffer located along the south property line. The standard residential adjacency buffer is 20-foot; however, the Unified Development Code (UDC) increases this requirement to 50-feet for buildings that are greater than 50,000 SF in size (*Subsection 04.01. E, of Article 05, UDC*). In addition, please indicate the screening method. Per the Unified Development Code (UDC) the screening for the 20-foot buffer is either, (1) a masonry screening wall with canopy trees on 20-foot centers, or (2) three (3) tiered landscape screening (*i.e. a row of canopy trees, a row of accent trees, and a row of evergreen shrubs*); for the 50-foot buffer, evergreen shrubs and a berm is

required. In this case, you are requesting a hybrid between the two (2). The Planning and Zoning has the authority to approve alternative screening plans, which is what this would be considered. That being said, the buffer must be 50-feet, and there is a point where this fall short. In addition, buffers are not allowed to have paving within them. Given this, there will be an Exception. In conclusion, (1) the buffer must be shown as 50-feet, (2) the alternative screening can be approved by the Planning and Zoning Commission, and (3) there is an exception due to there being paving in the buffer and the small portion that is under 50-feet. (*Subsection 01.06, of Article 05, UDC*)

M.9 Treescape Plan:

- (1) Provide the same site data information required in Section 2.1 *Site Plan: Miscellaneous and Density and Dimensional Requirements* of the checklist. (*See Sec. 2.1 of the Site Plan Checklist*).
- (2) The Treescape table indicates that 59 Eastern Red Cedar trees – *over eight (8) feet in height* -- are being removed. Based on the mitigation requirements, each Eastern Red Cedar over eight (8) feet in height, required one (1) 4-inch caliper tree to be planted. This effectively makes the mitigation balance 236 caliper inches (*i.e. 59 x 4 = 236*). That being said, the landscaping provided covers the entire mitigation balance (*i.e. 236 caliper inches removed – 428 caliper inches planted*). (*Subsection 03.01. G, of Article 09, UDC*)

M.10 Photometric Plan:

- (1) Provide the same site data information required in Section 2.1 of the site plan checklist. (*See Section 2.1 of the site plan checklist*)
- (2) The Foot Candles cannot exceed 20 FC. It appears that light levels exceed this amount on the west side of the building, and near the loading docks. (*Subsection 03.03. G, of Article 07, UDC*)
- (3) No light pole, base or combination thereof shall exceed 20 feet due to the *General Overlay District Standards*. (*Subsection 03.03. D, of Article 07, UDC*)
- (4) Please provide the cutsheets for all of the proposed light fixtures. (*Subdivision 03.03, of Article 07, UDC*)

M.11 Building Elevations:

- (1) Please remove the windows from the material percentages. Doors and windows do not count toward the total percentage. (*Subsection 04.01, of Article 05, UDC*)
- (2) Exterior walls should consist of 90% masonry materials. The east and north sides of the building do not meet this requirement. This will be a Variance. (*Subsection 06.02. C, of Article 05, UDC*)
- (3) Please provide a note that the interior side of the parapets shall be finished in the same material as the exterior facing façade. That being said, the parapets may be painted to match the exterior; however, it is an Exception. Please clarify with staff with the course of action. (*Subsection 04.01, of Article 05, UDC*)
- (4) Please crosshatch the RTUs on the building elevations. In addition, there are RTUs that will be visible from John King Boulevard near SH-276. Please provide a four (4) lover system around the RTUs closest to John King Boulevards. Please see the attached exhibit. (*Subsection 01.05. C, of Article 05, UDC*)
- (5) The proposed building elevations do not meet the primary façade articulation requirements on all sides of the proposed building. In this case, the primary façade articulation standards apply to all sides of the building due to the Four (4) Sided Architecture requirements contained in the *General Overlay District Standards*. All that being said, this is not uncommon for buildings of this size. This will be a Variance. (*Subsection 04.01. C. 1, of Article 05, UDC*)

I.12 Staff has identified the following exception(s) and variance(s) associated with the proposed request: [1] more than one (1) row of parking between the building and the roadway, [2] less than 20% landscaped area, [3] less than 90% masonry material, [4] primary articulation, [5] parking greater than 80-feet from a canopy tree, and [6] residential adjacency buffer. Should you decide to request these items as variance(s)/exception(s), please provide a letter that lists the variance(s)/exception(s), why they are being requested, and the subsequent compensatory measures. For each variance/exception requested the UDC requires two (2) compensatory measures (*Subsection 09.01, of Article 11*). Examples of compensatory measures include the increased use of masonry material or stone, increased articulation, increased architectural elements, more pedestrian amenity, larger landscape planting sizes, etc.

I.13 As compensatory measures staff has identified a few options: (1) increased caliper size for the canopy trees, (2) a Trail Head/Pedestrian Rest Stop (*i.e. see Appendix B, Trail Rest Stops*), and (3) outdoor seating for the restaurant (*i.e. near the north east side of the building*). That being said, the staff identified compensatory measures are not required, as the applicant may propose other compensatory measures.

- I.14 Please note that failure to address all comments provided by staff by 3:00 PM on January 3, 2024 will result in the automatic denial of the case on the grounds of an incomplete submittal. No refund will be given for cases that are denied due to an incomplete submittal, and a new application and fee will be required to resubmit the case.
- I.15 Staff has identified the aforementioned items necessary to continue the submittal process. Please make these revisions and corrections, and provide any additional information that is requested. Revisions for this case will be due on January 3, 2024; however, it is encouraged for applicants to submit revisions as soon as possible to give staff ample time to review the case prior to the January 9, 2024 Planning & Zoning Meeting.
- I.16 Please note the scheduled meetings for this case:
1) Planning & Zoning Work Session meeting will be held on December 27, 2023.
2) Planning & Zoning meeting/public hearing meeting will be held on January 9, 2024.
- I.17 If the Planning and Zoning Commission approves this site plan case, the applicant will be responsible for submitting hard copies of the final site plan submittal package -- *with all comments addressed* -- for signatures from the Planning and Zoning Commission Chairman and Director of Planning and Zoning. Please note that this will be required to be completed prior to the acceptance of civil engineering plans.
- I.18 All meetings will be held in person and in the City's Council Chambers. All meetings listed above are scheduled to begin at 6:00 p.m. (P&Z). The City prefers that a representative(s) be present for these meetings. During the upcoming work session meeting with the Planning and Zoning Commission, representative(s) are expected to present their case and answer any questions the Planning Commission may have regarding this request.

ENGINEERING COMMENTS:

1. Water line may not be in detention easement. Minimum 10' separation.
2. 20' water easement. No covers/structures in easement. Also, must have 5' clear around all fire hydrants including parking spaces
3. 20' parking spaces.
4. Remove driveway. Not needed per FD. Need landscaping here.
5. Use Auto-turn to ensure trucks can maneuver and turn around in the area.
6. 20' water easement.
7. Will need signage for any one-way drive aisles.
8. Proposed flow to this system may not exceed undeveloped (C=.35) flow rate.
9. Min. parking space is 9'x20'.
10. Label typical width (min. 9').
11. 20' water easement.
12. Remove approach and continue landscaping in this area.
13. Show visibility triangle for this intersection.
14. Steel edging must be above mulch to prevent it from leaving the landscape bed.

General Comments:

General Items:

- Must meet 2023 City Standards of Design and Construction.
- 4% Engineering Inspection Fees
- Impact Fees (Water, Wastewater & Roadway)
- Must extend sidewalk along S. John King Blvd.
- Tree mitigation shall be provided for any trees removed on site.
- Minimum easement width is 20' for new easements.
- No structures, including walls, allowed in easements.
- Retaining walls 3' and greater must be engineered.
- Retaining walls 18" and greater must be rock or stone face. No smooth concrete walls.
- No signage is allowed within easements or ROW.
- Must plat the property.

Drainage Items:

- The site is currently draining to 2 existing wye inlets on the Marquis Rockwall site located south of the property.
- Existing site flow patterns must be maintained.
- Detention is required. No vertical walls allowed in detention easement.
- Drainage calculations based on property zoning, not land area use.
- The property owner will be responsible for maintaining, repair, and replacement of the detention/drainage systems.
- No public water or sanitary sewer allowed in detention easements.
- No grate inlets allowed.
- 100-year WSEL must be called out for detention systems.
- FFE for all buildings must be called out when adjacent to a detention system. Minimum 2' above 100-year WSEL.
- Dumpster areas to drain to oil/water separator and then to the storm lines.

Water and Wastewater Items:

- Minimum public sewer is 8".
- May connect to the existing 8" sewer main stub located on the south side of the property near the Marquis Rockwall site.
- Water and sewer must be 10' apart and must be centered in easement.
- Only one "use" off a dead-end line (domestic, irrigation, fire sprinkler, fire hydrant, etc.)
- May use existing 8" water line stub located on the west side of the property near the Honda driveway.
- May be required to loop proposed 8" water line on site.
- Utility work within TxDOT ROW will require a TxDOT permit.
- Sewer pro-rata of \$1924.04/acre due prior to civil permit release.

Roadway Paving Items:

- Parking to be 20'x9'
- No dead-end parking allowed without a City approved turnaround.
- Drive isles to be 24' wide.
- Fire lane to have 20' min radius if buildings are less than 30' tall. If any of the buildings are 30' or more, the fire lane will be 30' radius minimum.
- Fire lane to be in a platted easement.
- Need to make sure that the angled parking meets the size requirement dependent on the angle of the parking (60 degree = 20.1' & 45 degree = 19' parking spot depth and all 9' wide min.)
- Don't "clip" end angled parking

Landscaping:

- No trees to be with 10' of any public water, sewer or storm line that is 10" in diameter or larger.
- No trees to be with 5' of any public water, sewer, or storm line that is less than 10".

BUILDING INSPECTIONS COMMENTS:

- Oil/Water separators must be sized by an Engineer and information provided with the Building Permit submittal
- Signage & Irrigation require separate permits

FIRE DEPARTMENT COMMENTS:

- FDC shall be facing and visible from the fire lane.
- FDC must be within 100 feet of a fire hydrant and within 50 feet of the fire lane.
- The FDC shall be clear and unobstructed, with a minimum of a 5-foot-clear all-weather path from fire lane access.

GIS COMMENTS:

- Assigned address will be: 1600 E INTERSTATE 30, ROCKWALL, TX 75032

PARKS DEPARTMENT COMMENTS:

- 4" Caliper trees required by ordinance (canopy / shade)
- Common Bermuda is a dated turfgrass variety and there are many other varieties available that very cold, wear, drought tolerant: Tif Tuf, Tahoma 31, Latitude 36, etc. Tif Tuf is one that we have tested and use in Parks and Recreation in Rockwall and main benefits are that it stays green into December, greens up in February and most importantly much less water usage.

General Items: - Must meet 2023 City Standards of Design and Construction. - 4% Engineering Inspection Fees- Impact Fees (Water, Wastewater & Roadway)- Must extend sidewalk along S. John King Blvd. - Tree mitigation shall be provided for any trees removed on site. - Minimum easement width is 20' for new easements. - No structures, including walls, allowed in easements. - Retaining walls 3' and greater must be engineered. - Retaining walls 18" and greater must be rock or stone face. No smooth concrete walls. - No signage is allowed within easements or ROW. - Must plat the property. **Drainage Items:** - The site is currently draining to 2 existing wye inlets on the Marquis Rockwall site located south of the property. - Existing site flow patterns must be maintained. - Detention is required. No vertical walls allowed in detention easement. - Drainage calculations based on property zoning, not land area use. - The property owner will be responsible for maintaining, repair, and replacement of the detention/drainage systems. - No public water or sanitary sewer allowed in detention easements. - No grate inlets allowed. - 100-year WSEL must be called out for detention systems. - FFE for all buildings must be called out when adjacent to a detention systems. Minimum 2' above 100-year WSEL. - Dumpster areas to drain to oil/water separator and then to the storm lines. **Water and Wastewater Items:** - Minimum public sewer is 8". - May connect to the existing 8" sewer main stub located on the south side of the property near the Marquis Rockwall site. - Water and sewer must be 10' apart and must be centered in easement. - Only one "use" off a dead-end line (domestic, irrigation, fire sprinkler, fire hydrant, etc.) - May use existing 8" water line stub located on the west side of the property near the Honda driveway. - May be required to loop proposed 8" water line on site. - Utility work within TxDOT ROW will require a TxDOT permit. - Sewer pro-rata of \$1924.04/acre due prior to civil permit release. **Roadway Paving Items:** - Parking to be 20'x9' - No dead-end parking allowed without an City approved turnaround. - Drive isles to be 24' wide. - Fire lane to have 20' min radius if buildings are less than 30' tall. If any of the buildings are 30' or more, the fire lane will be 30' radius minimum. - Fire lane to be in a platted easement. - Need to make sure that the angled parking meet the size requirement dependent on the angle of the parking (60 degree = 20.1' & 45 degree = 19' parking spot depth and all 9' wide min.) - Don't "clip" end angled parking. **Landscaping:** - No trees to be with 10' of any public water, sewer or storm line that is 10" in diameter or larger. - No trees to be with 5' of any public water, sewer, or storm line that is less than 10".

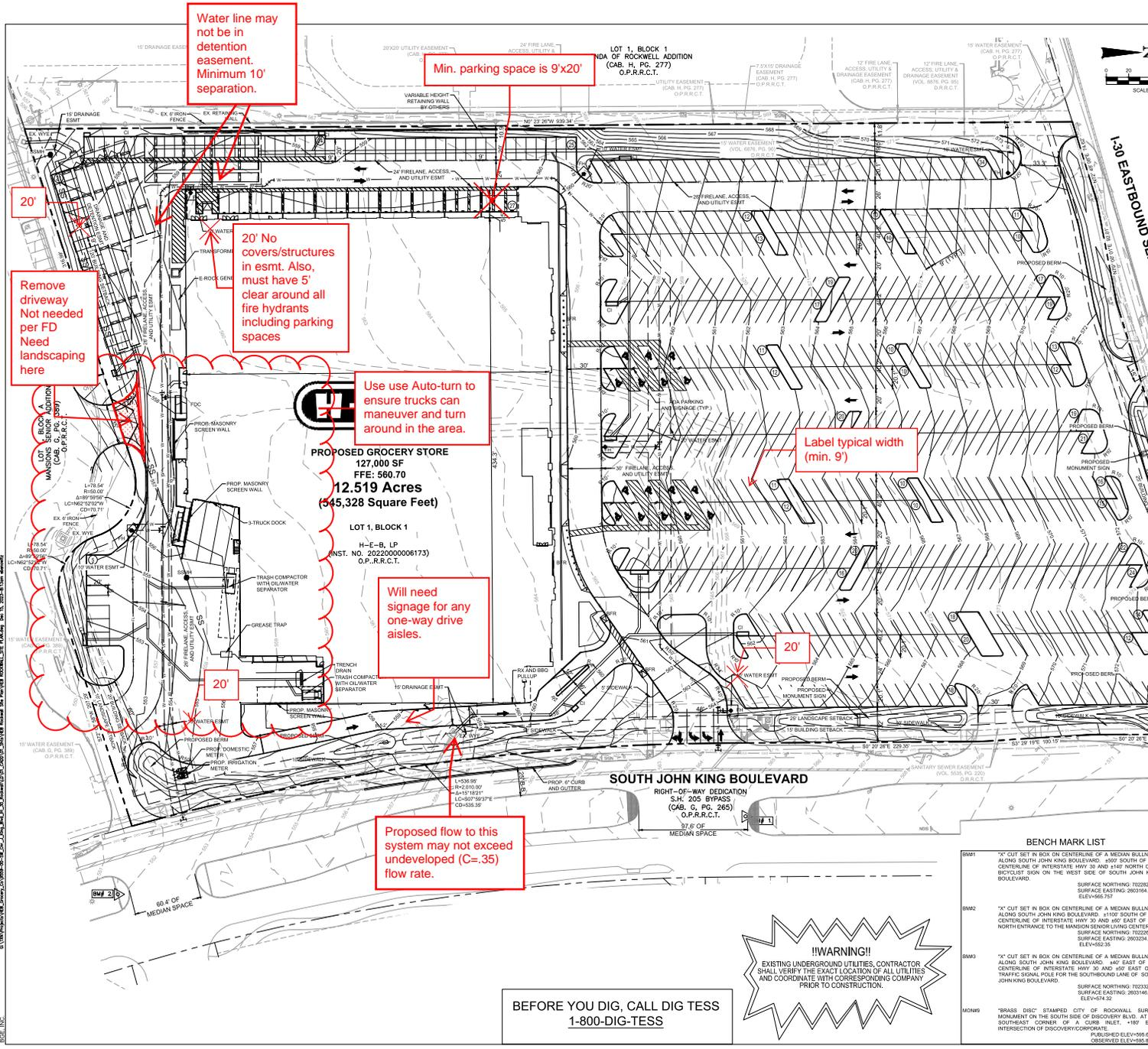

THE DOCUMENT, TOGETHER WITH THE CONCEPTS AND DESIGN PRESENTED HEREIN, IS AN INSTRUMENT OF SERVICE. IT IS INTENDED ONLY FOR THE SPECIFIC PURPOSE AND CLIENT FOR WHICH IT WAS PREPARED. REUSE OF AND IMPROPER RELIANCE ON THIS DOCUMENT WITHOUT AUTHORIZATION AND ADAPTATION BY BGE, INC. SHALL BE WITHOUT LIABILITY TO BGE, INC.



PROPOSED GROCERY STORE
 127,000 SF
 FFE: 560.70
12.519 Acres
 (545,328 Square Feet)

LOT 1, BLOCK 1
 H-E-B, LP
 (INST. NO. 20220000006173)
 O.P., R.R. C.T.

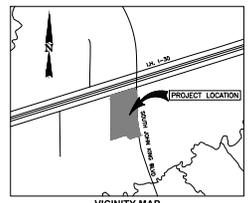
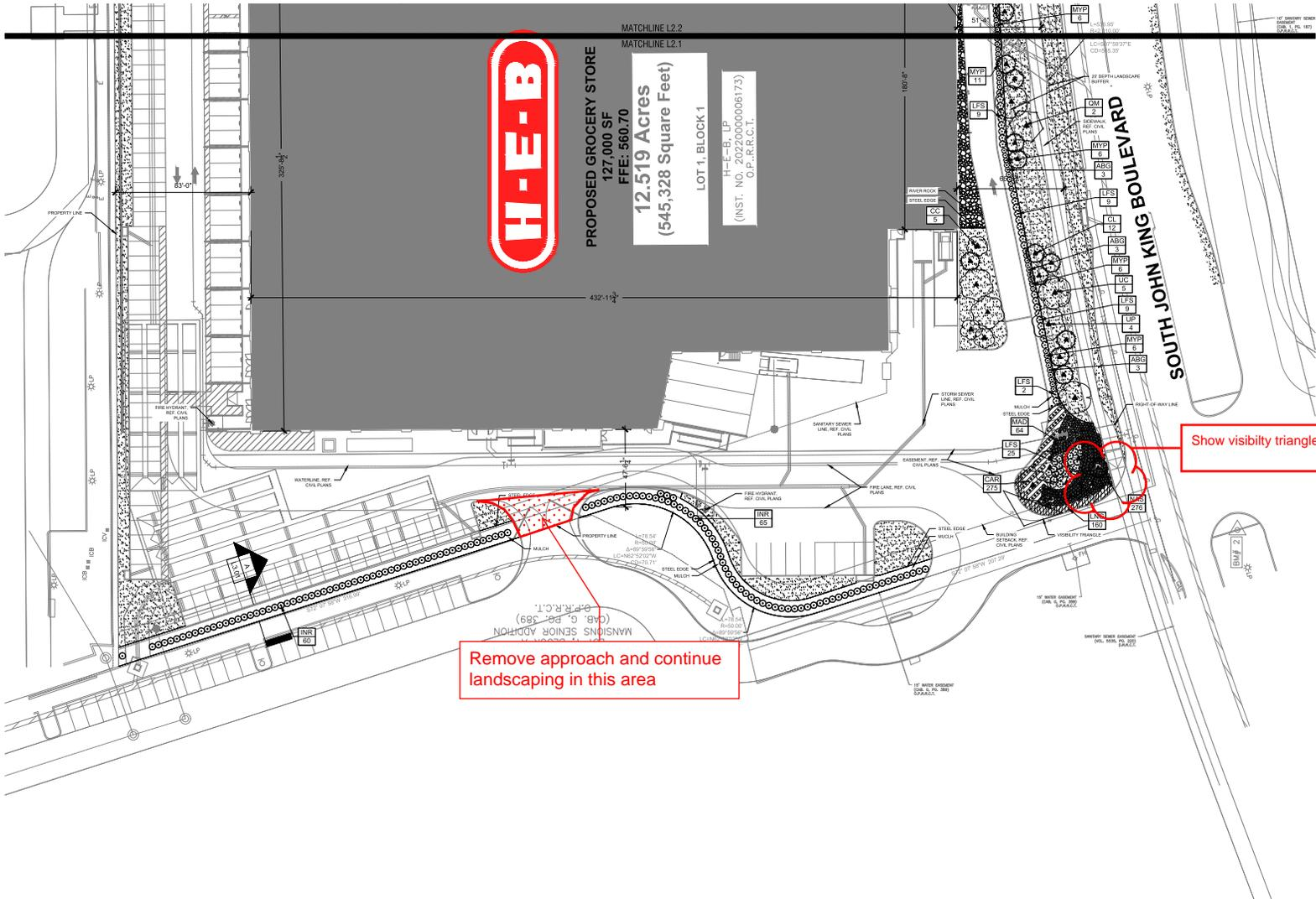

Show visibility triangle for this intersection.

Remove approach and continue landscaping in this area

BGE, Inc.
 2595 Dallas Parkway, Suite 101
 Frisco, TX 75034
 Tel: 972-464-4800 • www.bgeinc.com
 TBPE Registration No. F-1046
 Copyright 2023

OWNER/DEVELOPER

 648 S. FLORES ST.
 SAN ANTONIO, TX 78204
 TEL: (210) 938-4076
 CONTACT: LANCE KLEIN

LANDSCAPE ARCHITECT
BGE, INC.
 2595 DALLAS PKWY., SUITE 101
 FRISCO, TX 75034
 CONTACT: MICHAEL STOTTLER, PLA
 STOTTLER, PLA
 PHONE: (972) 372-9381

PLANTING PLAN
H-E-B ROCKWALL
 LOT 1, BLOCK 1
 CITY OF ROCKWALL, ROCKWALL COUNTY, TEXAS

THESE PLANS ARE ISSUED FOR THE PURPOSE OF PRELIMINARY REVIEW AND ARE NOT INTENDED FOR CONSTRUCTION. WHEN ISSUED IN FINAL FORM THEY WILL BE SEALED, SIGNED AND DATED.

RESPONSIBLE LANDSCAPE ARCHITECT:
 MICHAEL STOTTLER, PLA
 TEXAS REGISTRATION NO. 2143
 BGE, INC.
 TEXAS REGISTERED ENGINEERING FIRM F-1046

CAUTION II
 Contractor to verify exact location & depth of Existing Facilities Prior to any Construction Activities.

CAUTION III
 CONTACT - 800-GIS-TESS
 24 HOURS PRIOR TO CONSTRUCTION

REVISIONS	DATE	DESCRIPTION

CHECKED BY: MLS
 DESIGNED BY: ACS
 DATE: December 13, 2023
 PROJECT NUMBER: 959901

SHEET NO
L2.01
 PLANTING PLAN

THIS DOCUMENT, TOGETHER WITH THE CONCEPTS AND DESIGN PRESENTED HEREIN, IS AN INSTRUMENT OF SERVICE, IS INTENDED ONLY FOR THE SPECIFIC PURPOSE AND CLIENT FOR WHICH IT WAS PREPARED, VALUE OF, AND IMPROVES RELIANCE ON THE DOCUMENTATION AND ADAPTATION BY BGE, INC. SHALL BE WITHOUT LIABILITY TO BGE, INC.

ArborBrace™
Tree Guying System
(305) 992-4104

ArborBrace Tree Guying Specifications: ATG-R
For up to 4" Caliper Trees (3) Polypropylene guylines 3/4" X 12'-800 lb test, olive drab, UV resistant (3) Nickel plated spring cam-lock tension clips (3) Arrowhead Nylon Anchors (4" X 3-3/4")

Arbor Anchor™
ArborAnchor driven below grade to necessary depth determined by soil. (1.5 to 2.5 feet as required)

ArborBrace Tree Guying Specifications: ATG-J
For up to 6" Caliper Trees (3) Polypropylene guylines 1" X 12'-1,000 lb test, olive drab, UV resistant (3) 1-1/4" Nickel plated, non-rusting spring cam-lock tension clips (1,500 lb break strength) (3) Arrowhead Nylon Anchors (5-1/2" X 4-1/2")

Tension Buckle
Loop loose end of webbing around leading branch of tree. Tie 1/2 knot onto backside of buckle. Pull buckle towards ArborAnchor to tension line.

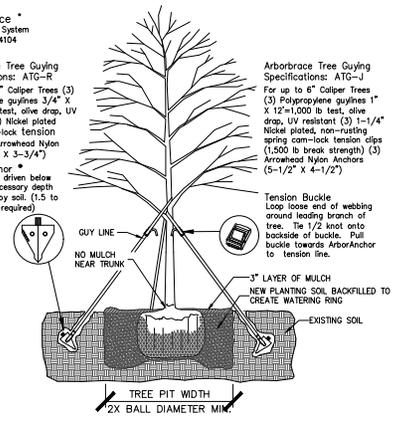

A SHADE TREE STAKING-ARBORBRACE
SECTION NOT TO SCALE

1. REMOVE SUCKER SHOOTS AT BASE OF TREE.
2. MAKE CLEAN CUTS ON OLD STUDS IF PRESENT.
3. REMOVE ENTIRE SUPPLY OF TWIGGS AND BUDS ON TRUNK.
4. REMOVE LOWER BRANCH WHERE AN OVERLYING BRANCH OCCUPIES APPROX. SAME AREA.
5. SHAPE TREE BY REMOVING INJURED AND MISSHAPE BRANCHES.
6. REMOVE CROSS BRANCHES AND THOSE DEVELOPING INTO SECONDARY LEADERS.
7. DO NOT REMOVE LEADER.



NOTE: DASHED LINES INDICATE BRANCHES TO BE REMOVED - NO MORE THAN 20 PERCENT OF LEAFS, FOLIAGE, ETC., TO BE REMOVED, UNLESS NOTED OTHERWISE

B SHADE TREE PRUNING
SECTION NOT TO SCALE

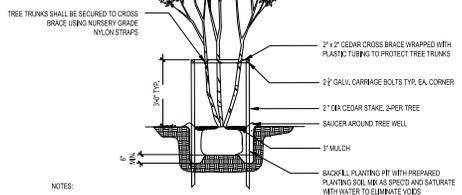
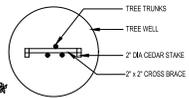

NOTES:
* TEMPORARY TREE WELL STAKES AND CROSS BRACE TO BE REMOVED AFTER ONE FULL GROWING SEASON
** APPROXIMATELY 1/2 OF THE BRANCH STRUCTURES SHALL BE REMOVED BY THINNING BUT THE NATURAL CHARACTER AND GENERAL SHAPE OF THE TREE SHALL BE PRESERVED

C ORNAMENTAL / MULTI-TRUNK TREE PLANTING
SECTION / ELEVATION NOT TO SCALE

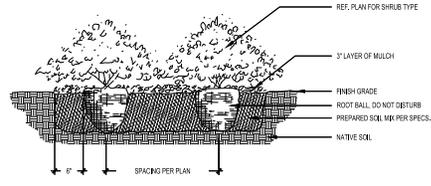

D SHRUB PLANTING
SECTION NOT TO SCALE

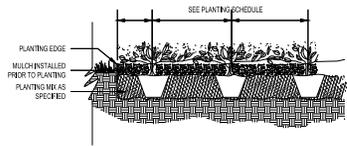

E GROUNDCOVER PLANTING
SECTION NOT TO SCALE

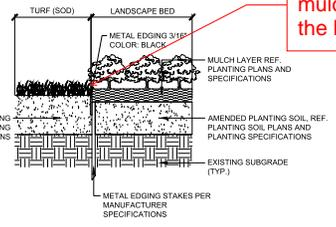

F STEEL EDGE
SECTION NOT TO SCALE

Steel edging must be above mulch to prevent it from leaving the landscape bed



BGE, Inc.
2595 Dallas Parkway, Suite 101
Frisco, TX 75034
Tel: 972-464-4800 • www.bgeinc.com
TBPE Registration No. F-1046
Copyright 2023

OWNER/DEVELOPER
HEB
648 S. FLORES ST.
SAN ANTONIO, TX 78204
TEL: (210) 938-4076
CONTACT: LANCE KLEIN

LANDSCAPE ARCHITECT
BGE, INC.
2595 DALLAS PKWY.,
SUITE 101
FRISCO, TX 75034
CONTACT: MICHAEL
STOTTLER, PLA
PHONE: (972) 372-9381

LANDSCAPE DETAILS

H-E-B ROCKWALL
LOT 1, BLOCK 1

CITY OF ROCKWALL, ROCKWALL COUNTY, TEXAS

THESE PLANS ARE ISSUED FOR THE PURPOSE OF PRELIMINARY REVIEW AND ARE NOT INTENDED FOR CONSTRUCTION. WHEN ISSUED IN FINAL FORM THEY WILL BE SEALED, SIGNED AND DATED.
RESPONSIBLE LANDSCAPE ARCHITECT:
MICHAEL STOTTLER, PLA
TEXAS REGISTRATION NO. 21743
BGE, INC.
TEXAS REGISTERED ENGINEERING FIRM F-1046
December 15, 2023

CAUTION II
Contractor to verify exact location & Depth of Existing Utilities Prior to any Construction Activities

CAUTION III
CONTACT 1-800-GO-TRESS 24 HOURS PRIOR TO CONSTRUCTION

REVISIONS	DATE	DESCRIPTION

CHECKED BY: MLS
DESIGNED BY: ACS
DATE: December 13, 2023
PROJECT NUMBER: 060901

SHEET NO
L3.01
LANDSCAPE DETAILS



DEVELOPMENT APPLICATION

City of Rockwall
Planning and Zoning Department
385 S. Goliad Street
Rockwall, Texas 75087

STAFF USE ONLY

PLANNING & ZONING CASE NO. _____

NOTE: THE APPLICATION IS NOT CONSIDERED ACCEPTED BY THE CITY UNTIL THE PLANNING DIRECTOR AND CITY ENGINEER HAVE SIGNED BELOW.

DIRECTOR OF PLANNING: _____

CITY ENGINEER: _____

PLEASE CHECK THE APPROPRIATE BOX BELOW TO INDICATE THE TYPE OF DEVELOPMENT REQUEST (SELECT ONLY ONE BOX):

PLATTING APPLICATION FEES:

- MASTER PLAT (\$100.00 + \$15.00 ACRE)¹
- PRELIMINARY PLAT (\$200.00 + \$15.00 ACRE)¹
- FINAL PLAT (\$300.00 + \$20.00 ACRE)¹
- REPLAT (\$300.00 + \$20.00 ACRE)¹
- AMENDING OR MINOR PLAT (\$150.00)
- PLAT REINSTATEMENT REQUEST (\$100.00)

SITE PLAN APPLICATION FEES:

- SITE PLAN (\$250.00 + \$20.00 ACRE)¹
- AMENDED SITE PLAN/ELEVATIONS/LANDSCAPING PLAN (\$100.00)

ZONING APPLICATION FEES:

- ZONING CHANGE (\$200.00 + \$15.00 ACRE)¹
- SPECIFIC USE PERMIT (\$200.00 + \$15.00 ACRE)^{1 & 2}
- PD DEVELOPMENT PLANS (\$200.00 + \$15.00 ACRE)¹

OTHER APPLICATION FEES:

- TREE REMOVAL (\$75.00)
- VARIANCE REQUEST/SPECIAL EXCEPTIONS (\$100.00)²

NOTES:

¹: IN DETERMINING THE FEE, PLEASE USE THE EXACT ACREAGE WHEN MULTIPLYING BY THE PER ACRE AMOUNT. FOR REQUESTS ON LESS THAN ONE ACRE, ROUND UP TO ONE (1) ACRE.
²: A **\$1,000.00** FEE WILL BE ADDED TO THE APPLICATION FEE FOR ANY REQUEST THAT INVOLVES CONSTRUCTION WITHOUT OR NOT IN COMPLIANCE TO AN APPROVED BUILDING PERMIT.

PROPERTY INFORMATION [PLEASE PRINT]

ADDRESS: PARCEL ID 11460 & 10027

SUBDIVISION: SUBDIVISION CODE A0134 & A0002

LOT: _____

BLOCK: _____

GENERAL LOCATION: SOUTHWEST CORNER OF I-30 & JOHN KING BLVD

ZONING, SITE PLAN AND PLATTING INFORMATION [PLEASE PRINT]

CURRENT ZONING: COMMERCIAL

CURRENT USE: VACANT

PROPOSED ZONING: COMMERCIAL

PROPOSED USE: GROCERY

ACREAGE: 12.519

LOTS [CURRENT]: 2

LOTS [PROPOSED]: 1

SITE PLANS AND PLATS: BY CHECKING THIS BOX YOU ACKNOWLEDGE THAT DUE TO THE PASSAGE OF HB3167 THE CITY NO LONGER HAS FLEXIBILITY WITH REGARD TO ITS APPROVAL PROCESS, AND FAILURE TO ADDRESS ANY OF STAFF'S COMMENTS BY THE DATE PROVIDED ON THE DEVELOPMENT CALENDAR WILL RESULT IN THE DENIAL OF YOUR CASE.

OWNER/APPLICANT/AGENT INFORMATION [PLEASE PRINT/CHECK THE PRIMARY CONTACT/ORIGINAL SIGNATURES ARE REQUIRED]

OWNER: HEB, LP

APPLICANT: BGE, INC.

CONTACT PERSON: BEN SCOTT

CONTACT PERSON: NICK HOBBS

ADDRESS: 646 SOUTH FLORES STREET

ADDRESS: 2595 DALLAS PKWY, SUITE 101

CITY, STATE & ZIP: SAN ANTONIO, TEXAS 78204

CITY, STATE & ZIP: FRISCO, TEXAS 75034

PHONE: 210-938-4075

PHONE: 469-644-1664

E-MAIL: _____

E-MAIL: NHOBBS@BGEINC.COM

NOTARY VERIFICATION [REQUIRED]

BEFORE ME, THE UNDERSIGNED AUTHORITY, ON THIS DAY PERSONALLY APPEARED Ben Scott [OWNER] THE UNDERSIGNED, WHO STATED THE INFORMATION ON THIS APPLICATION TO BE TRUE AND CERTIFIED THE FOLLOWING:

"I HEREBY CERTIFY THAT I AM THE OWNER FOR THE PURPOSE OF THIS APPLICATION; ALL INFORMATION SUBMITTED HEREIN IS TRUE AND CORRECT; AND THE APPLICATION FEE OF \$ 500.38 TO COVER THE COST OF THIS APPLICATION, HAS BEEN PAID TO THE CITY OF ROCKWALL ON THIS THE 15th DAY OF December, 2023. BY SIGNING THIS APPLICATION, I AGREE THAT THE CITY OF ROCKWALL (I.E. "CITY") IS AUTHORIZED AND PERMITTED TO PROVIDE INFORMATION CONTAINED WITHIN THIS APPLICATION TO THE PUBLIC. THE CITY IS ALSO AUTHORIZED AND PERMITTED TO REPRODUCE ANY COPYRIGHTED INFORMATION SUBMITTED IN CONJUNCTION WITH THIS APPLICATION, IF SUCH REPRODUCTION IS ASSOCIATED OR IN RESPONSE TO A REQUEST FOR PUBLIC INFORMATION."

GIVEN UNDER MY HAND AND SEAL OF OFFICE ON THIS THE 5th DAY OF December, 2023.

OWNER'S SIGNATURE: [Signature]

NOTARY PUBLIC IN AND FOR THE STATE OF TEXAS: [Signature]

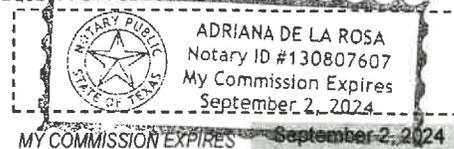

0 70 140 280 420 560 Feet

SP2023-047: Site Plan for Grocery Store (HEB)

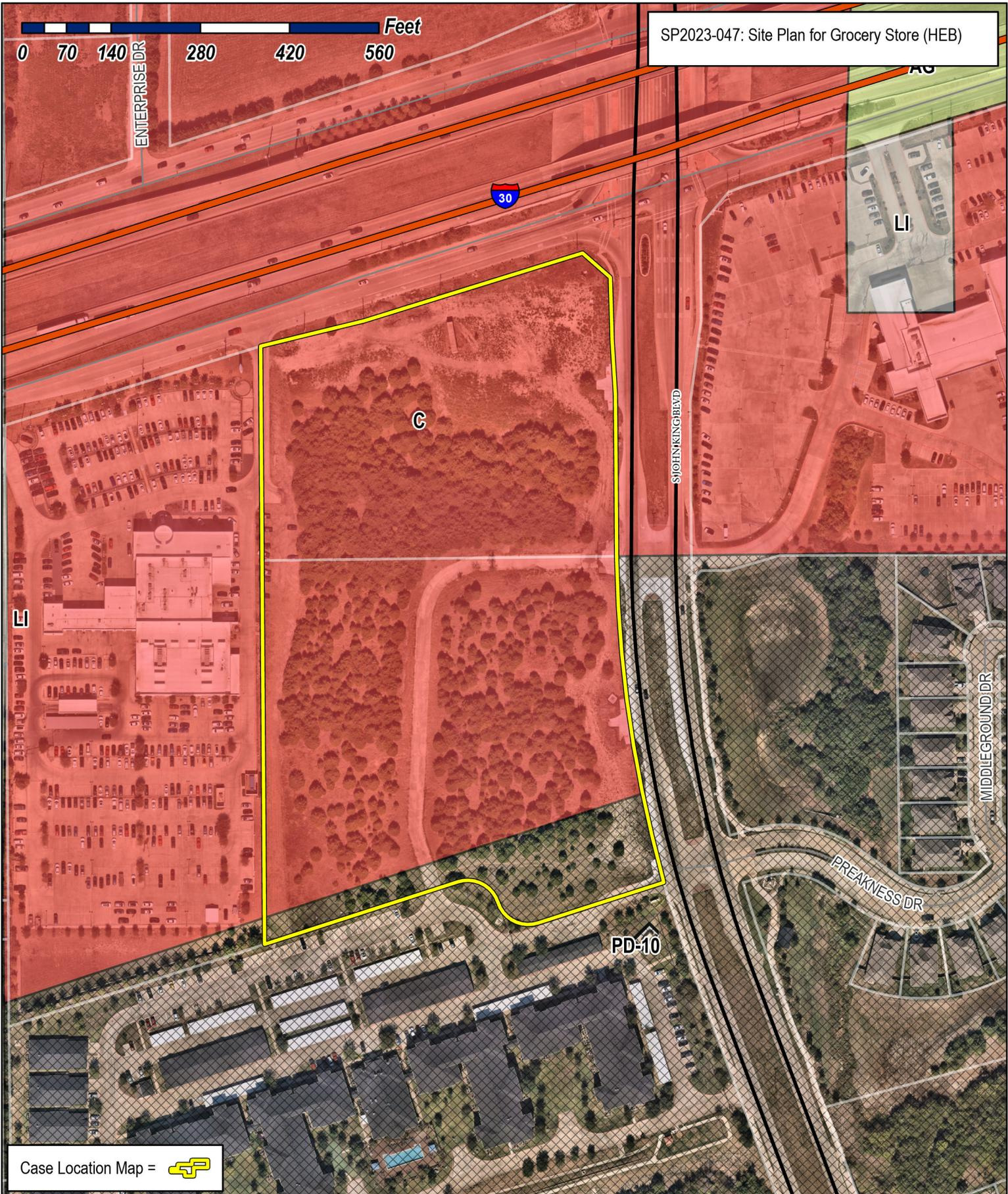

Case Location Map = 



City of Rockwall

Planning & Zoning Department
385 S. Goliad Street
Rockwall, Texas 75087
(P): (972) 771-7745
(W): www.rockwall.com

The City of Rockwall GIS maps are continually under development and therefore subject to change without notice. While we endeavor to provide timely and accurate information, we make no guarantees. The City of Rockwall makes no warranty, express or implied, including warranties of merchantability and fitness for a particular purpose. Use of the information is the sole responsibility of the user.



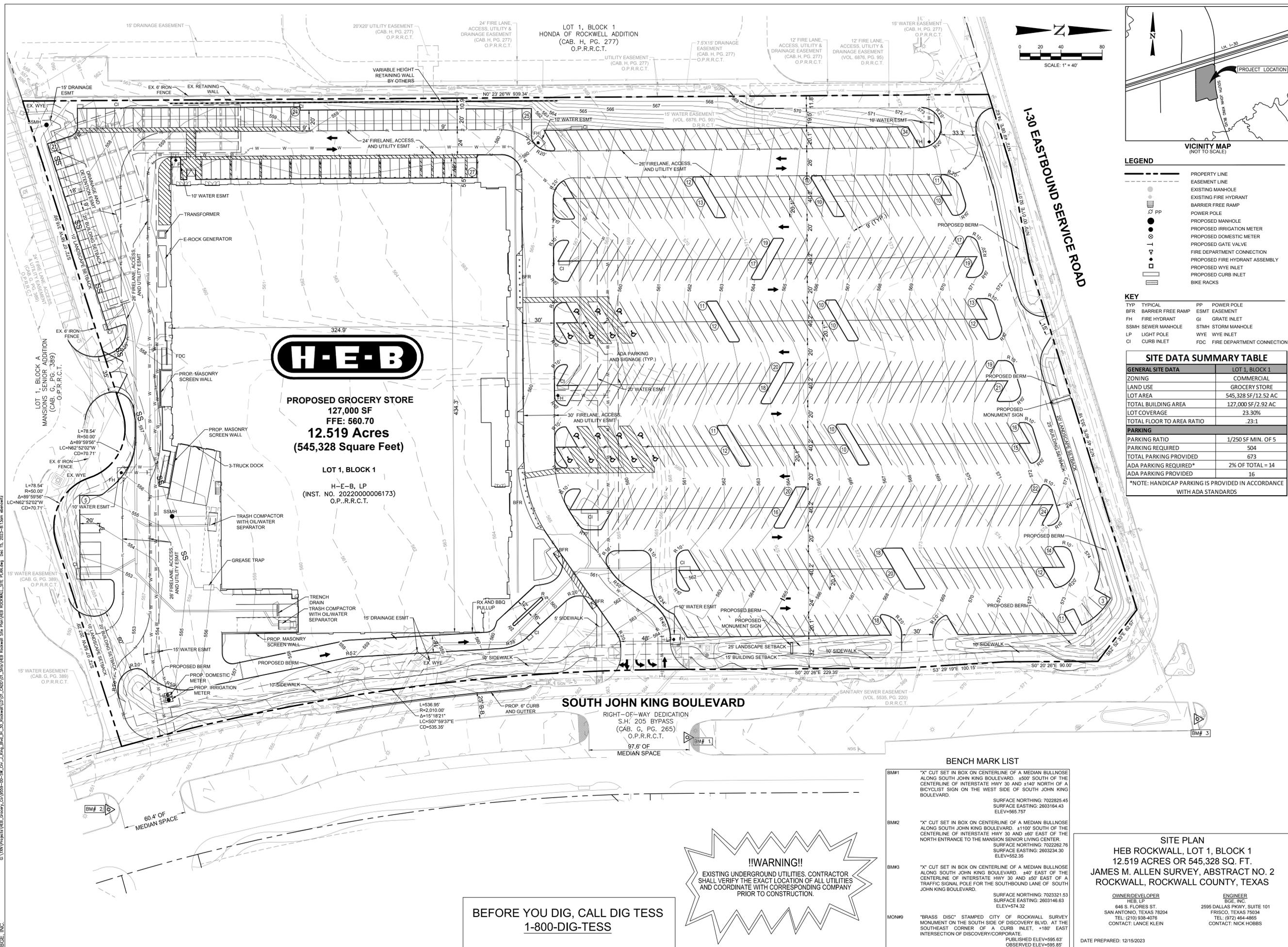

PROPOSED GROCERY STORE
127,000 SF
FFE: 560.70
12.519 Acres
(545,328 Square Feet)

LOT 1, BLOCK 1
 H-E-B, LP
 (INST. NO. 2022000006173)
 O.P.R.R.C.T.

SOUTH JOHN KING BOULEVARD

RIGHT-OF-WAY DEDICATION
 S.H. 205 BYPASS
 (CAB. G. PG. 265)
 O.P.R.R.C.T.
 97.6' OF
 MEDIAN SPACE

!!WARNING!!
 EXISTING UNDERGROUND UTILITIES. CONTRACTOR
 SHALL VERIFY THE EXACT LOCATION OF ALL UTILITIES
 AND COORDINATE WITH CORRESPONDING COMPANY
 PRIOR TO CONSTRUCTION.

BEFORE YOU DIG, CALL DIG TESS
1-800-DIG-TESS

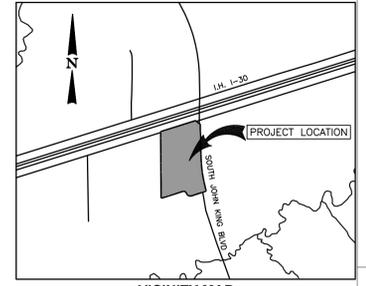
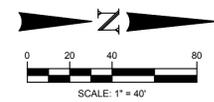

- LEGEND**
- PROPERTY LINE
 - - - EASEMENT LINE
 - EXISTING MANHOLE
 - EXISTING FIRE HYDRANT
 - ▭ BARRIER FREE RAMP
 - POWER POLE
 - PROPOSED MANHOLE
 - PROPOSED IRRIGATION METER
 - PROPOSED DOMESTIC METER
 - PROPOSED GATE VALVE
 - FIRE DEPARTMENT CONNECTION
 - PROPOSED FIRE HYDRANT ASSEMBLY
 - PROPOSED WYE INLET
 - PROPOSED CURB INLET
 - BIKE RACKS

- KEY**
- TYP TYPICAL
 - BFR BARRIER FREE RAMP
 - FH FIRE HYDRANT
 - SSMH SEWER MANHOLE
 - LP LIGHT POLE
 - CI CURB INLET
 - PP POWER POLE
 - ESMT EASEMENT
 - GI GRATE INLET
 - STMH STORM MANHOLE
 - WYE WYE INLET
 - FDC FIRE DEPARTMENT CONNECTION

SITE DATA SUMMARY TABLE	
GENERAL SITE DATA	LOT 1, BLOCK 1
ZONING	COMMERCIAL
LAND USE	GROCERY STORE
LOT AREA	545,328 SF/12.52 AC
TOTAL BUILDING AREA	127,000 SF/2.92 AC
LOT COVERAGE	23.30%
TOTAL FLOOR TO AREA RATIO	.23:1
PARKING	
PARKING RATIO	1/250 SF MIN. OF 5
PARKING REQUIRED	504
TOTAL PARKING PROVIDED	673
ADA PARKING REQUIRED*	2% OF TOTAL = 14
ADA PARKING PROVIDED	16

*NOTE: HANDICAP PARKING IS PROVIDED IN ACCORDANCE WITH ADA STANDARDS

BENCHMARK LIST

BMM#1	"X" CUT SET IN BOX ON CENTERLINE OF A MEDIAN BULLNOSE ALONG SOUTH JOHN KING BOULEVARD, +530' SOUTH OF THE CENTERLINE OF INTERSTATE HWY 30 AND +140' NORTH OF A BICYCLIST SIGN ON THE WEST SIDE OF SOUTH JOHN KING BOULEVARD. SURFACE NORTHING: 7022825.45 SURFACE EASTING: 2603164.43 ELEV=565.757
BMM#2	"X" CUT SET IN BOX ON CENTERLINE OF A MEDIAN BULLNOSE ALONG SOUTH JOHN KING BOULEVARD, +1100' SOUTH OF THE CENTERLINE OF INTERSTATE HWY 30 AND +60' EAST OF THE NORTH ENTRANCE TO THE MANSION SENIOR LIVING CENTER. SURFACE NORTHING: 7022262.76 SURFACE EASTING: 2603324.30 ELEV=552.35
BMM#3	"X" CUT SET IN BOX ON CENTERLINE OF A MEDIAN BULLNOSE ALONG SOUTH JOHN KING BOULEVARD, +40' EAST OF THE CENTERLINE OF INTERSTATE HWY 30 AND +50' EAST OF A TRAFFIC SIGNAL POLE FOR THE SOUTHBOUND LANE OF SOUTH JOHN KING BOULEVARD. SURFACE NORTHING: 7023321.53 SURFACE EASTING: 2603146.63 ELEV=574.32
MON#9	"BRASS DISC" STAMPED CITY OF ROCKWALL SURVEY MONUMENT ON THE SOUTH SIDE OF DISCOVERY BLVD. AT THE SOUTHEAST CORNER OF A CURB INLET, +180' EAST INTERSECTION OF DISCOVERY CORPORATE PUBLISHED ELEV=595.63 OBSERVED ELEV=595.85

SITE PLAN
HEB ROCKWALL, LOT 1, BLOCK 1
12.519 ACRES OR 545,328 SQ. FT.
JAMES M. ALLEN SURVEY, ABSTRACT NO. 2
ROCKWALL, ROCKWALL COUNTY, TEXAS

OWNER/DEVELOPER
 HEB LP
 646 S. FLORES ST.
 SAN ANTONIO, TEXAS 78204
 TEL: (210) 938-4076
 CONTACT: LANCE KLEIN

ENGINEER
 BGE, INC.
 2595 DALLAS PKWY, SUITE 101
 FRISCO, TEXAS 75034
 TEL: (972) 464-4865
 CONTACT: NICK HOBBS

DATE PREPARED: 12/15/2023

BGE, Inc.
 2595 Dallas Parkway, Suite 101
 Frisco, TX 75034
 Tel: 972-464-4800 • www.bgeinc.com
 TBPE Registration No. F-1046
 Copyright 2023

OWNER/DEVELOPER

646 S. FLORES ST.
 SAN ANTONIO, TX 78204
 TEL: (210) 938-4076
 CONTACT: LANCE KLEIN

ENGINEER
BGE, INC.
 2595 DALLAS PKWY.,
 SUITE 101
 FRISCO, TX 75034
 CONTACT: NICK HOBBS
 PHONE: (972) 464-4865

SITE PLAN

HEB ROCKWALL

LOT 1, BLOCK 1

CITY OF ROCKWALL, ROCKWALL COUNTY, TEXAS

THESE PLANS ARE ISSUED FOR THE PURPOSE OF PRELIMINARY REVIEW AND ARE NOT INTENDED FOR CONSTRUCTION. WHEN ISSUED IN FINAL FORM THEY WILL BE SEALED, SIGNED AND DATED.

RESPONSIBLE ENGINEER:
 BGE, INC.
 TEXAS REGISTERED ENGINEERING FIRM F-1046
 NICHOLAS D. HOBBS, P.E.
 TEXAS REGISTRATION NO. 112949
 DECEMBER 15, 2023

!CAUTION!
 Contractor to Verify exact location & Depth of Exist Facilities Prior to any Construction Activities

CAUTION !!!
 CONTACT: 1-800-DIG-TESS
 48 HOURS PRIOR TO CONSTRUCTION

REVISONS		
REV. NO.	DATE	DESCRIPTION

CHECKED BY: NDH
 DESIGNED BY: EJB
 DATE: DECEMBER 2023
 PROJECT NUMBER: 9559-01

SHEET NO
 SP-1

G:\TDM\Projects\HEB Grocery\CA\B555-05-25-23\JHEB Rockwall_Site_Plan\HEB Rockwall_Site_Plan.dwg, Dec 15, 2023, 8:13am, edwardz
 G:\TDM\Projects\HEB Grocery\CA\B555-05-25-23\JHEB Rockwall_Site_Plan\HEB Rockwall_Site_Plan.dwg, Dec 15, 2023, 8:13am, edwardz



5 PERSPECTIVE VIEW - POINT H

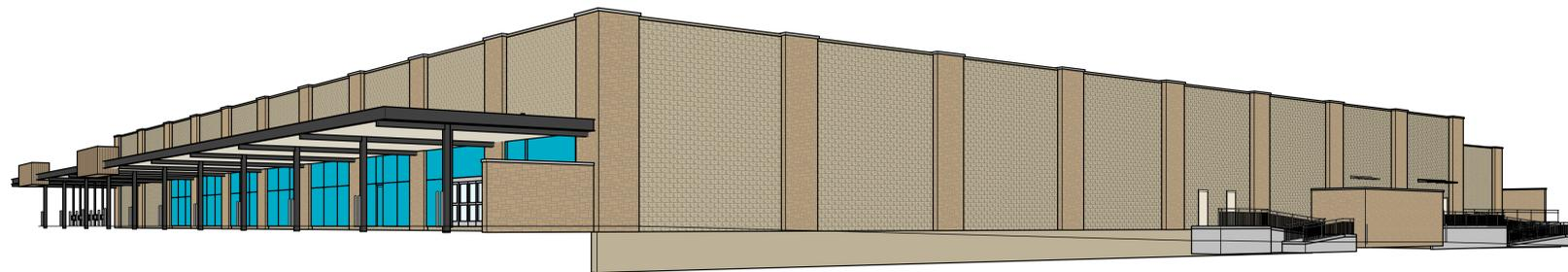

4 PERSPECTIVE VIEW - POINT G

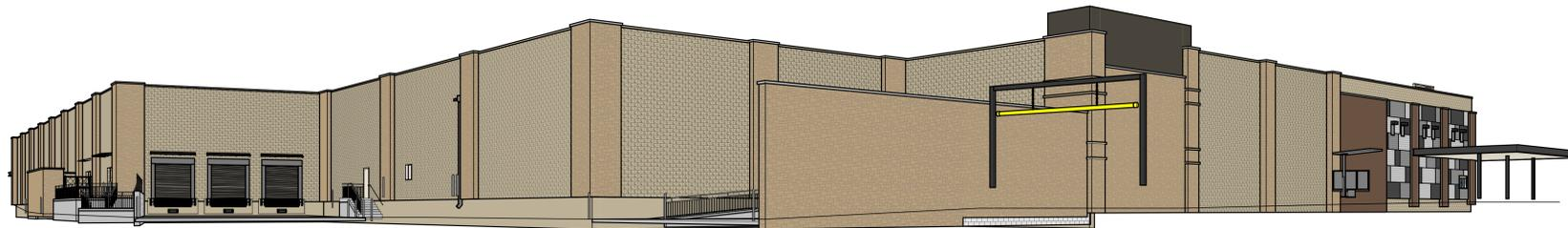

3 PERSPECTIVE VIEW - POINT F



2 PERSPECTIVE VIEW - POINT E

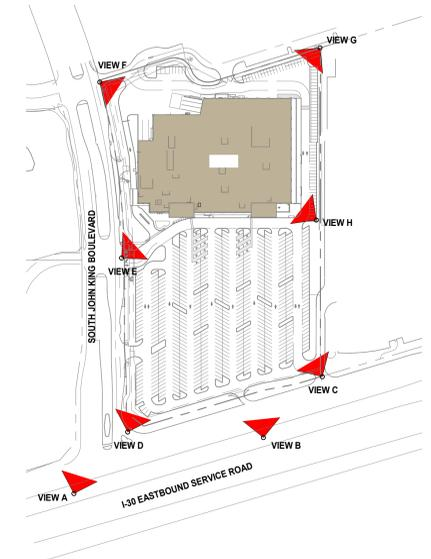

VIEW	STORE LEVEL	GRADE LEVEL	EYE LEVEL
A	560.30'	573'	560.30'
B	560.30'	284'	560.30'
C	560.30'	573'	560.30'
D	560.30'	573'	560.30'
E	560.30'	594'	560.30'
F	560.30'	552'	560.30'
G	560.30'	555'	560.30'
H	560.30'	561'	560.30'

1 ARCHITECTURAL SITE PLAN
1" = 200'-0"

PROJECT #
H.E.B. ROCKWALL - STORE
12.519 ACRES
LOT 1 | BLOCK 1
AN ADDITION TO THE CITY OF ROCKWALL
ROCKWALL COUNTY, TEXAS
DECEMBER, 2023

GROCERY COMPANY LP OWNER
646 S. FLORES ST. (210) 938-4076
SAN ANTONIO, TEXAS 78204
CONTACT: LANCE KLEIN

BGE, INC ENGINEER
2595 DALLAS PKWY, SUITE 101 (972) 464-4865
FRISCO, TEXAS 75034
CONTACT: NICK HOBBS

- CITY OF ROCKWALL GENERAL NOTES**
1. THIS FACADE PLAN IS FOR CONCEPTUAL PURPOSES ONLY. ALL BUILDING PLANS REQUIRE REVIEW AND APPROVAL FROM THE BUILDING INSPECTIONS DIVISION.
 2. ALL MECHANICAL EQUIPMENT SHALL BE SCREENED FROM PUBLIC VIEW. ROOF TOP MOUNTED EQUIPMENT SHALL BE SCREENED BY A PARAPET WALL OR SCREENING WALL. SCREENING WALLS SHALL BE PAINTED TO MATCH THE BUILDING.
 3. WHEN PERMITTED, EXPOSED UTILITIES BOXES AND CONDUITS SHALL BE PAINTED TO MATCH THE BUILDING.
 4. ALL SIGNAGE AREAS AND LOCATIONS ARE SUBJECT TO APPROVAL BY THE BUILDING INSPECTIONS DIVISION.
 5. WINDOWS SHALL HAVE A MINIMUM EXTERIOR VISIBLE REFLECTIVITY OF TEN (10) PERCENT.
 6. ANY DEVIATION FROM THE APPROVED FACADE PLAN WILL REQUIRE RE-APPROVAL BY THE TOWN OF PROSPER.

CITY APPROVAL

PLEASE BE ADVISED, THIS DOCUMENT MAY CONTAIN INFORMATION THAT IS UNLAWFUL TO DISCLOSE. THESE DISCLOSURES MUST BE TREATED AS CONFIDENTIAL DOCUMENTS. ACCEPTANCE OF THIS DOCUMENT SHALL BE DEEMED AS ACCEPTANCE OF THE INFORMATION CONTAINED HEREIN. NO PART OF THIS DOCUMENT SHALL BE REPRODUCED OR TRANSMITTED IN ANY FORM OR BY ANY MEANS, WITHOUT THE EXPRESS WRITTEN PERMISSION OF H.E.B. GROCERY AND DISTRIBUTION TO NON-AFFILIATED ENTITIES IS STRICTLY PROHIBITED. FOR A COMPLETE CONFIDENTIALITY AGREEMENT, CONTACT THE ARCHITECT.

Revision	Description	Date

THESE DOCUMENTS ARE FOR INFORMATION ONLY AND ARE NOT INTENDED FOR BIDDING, PERMITTING OR CONSTRUCTION PURPOSES.
ARCHITECT:
RSP ARCHITECTS, LTD.

RSP Architects
600 W. 4th Street, Suite 100
Fort Worth, TX 76102
817.200.0340 main
817.277.4658 fax
www.rsparchitect.com



SITE LINE STUDY

H.E.B. ROCKWALL | CORP # 810
XXX-XXX-XXX | Rockwall, Texas
XXXX

SCALE: AS INDICATED
CONSUL. PROJ. NO.: 3443.01.01
DATE: 12.11.2023
SHEET NO. 03

BGE, INC. THE DOCUMENT, TOGETHER WITH THE CONCEPTS AND DESIGN PRESENTED HEREIN, AS AN INSTRUMENT OF SERVICE, IS INTENDED ONLY FOR THE SPECIFIC PURPOSE AND CLIENT FOR WHICH IT WAS PREPARED. REUSE OF AND IMPROPER RELIANCE ON THIS DOCUMENT WITHOUT WRITTEN AUTHORIZATION AND ADAPTATION BY BGE, INC. SHALL BE WITHOUT LIABILITY TO BGE, INC.

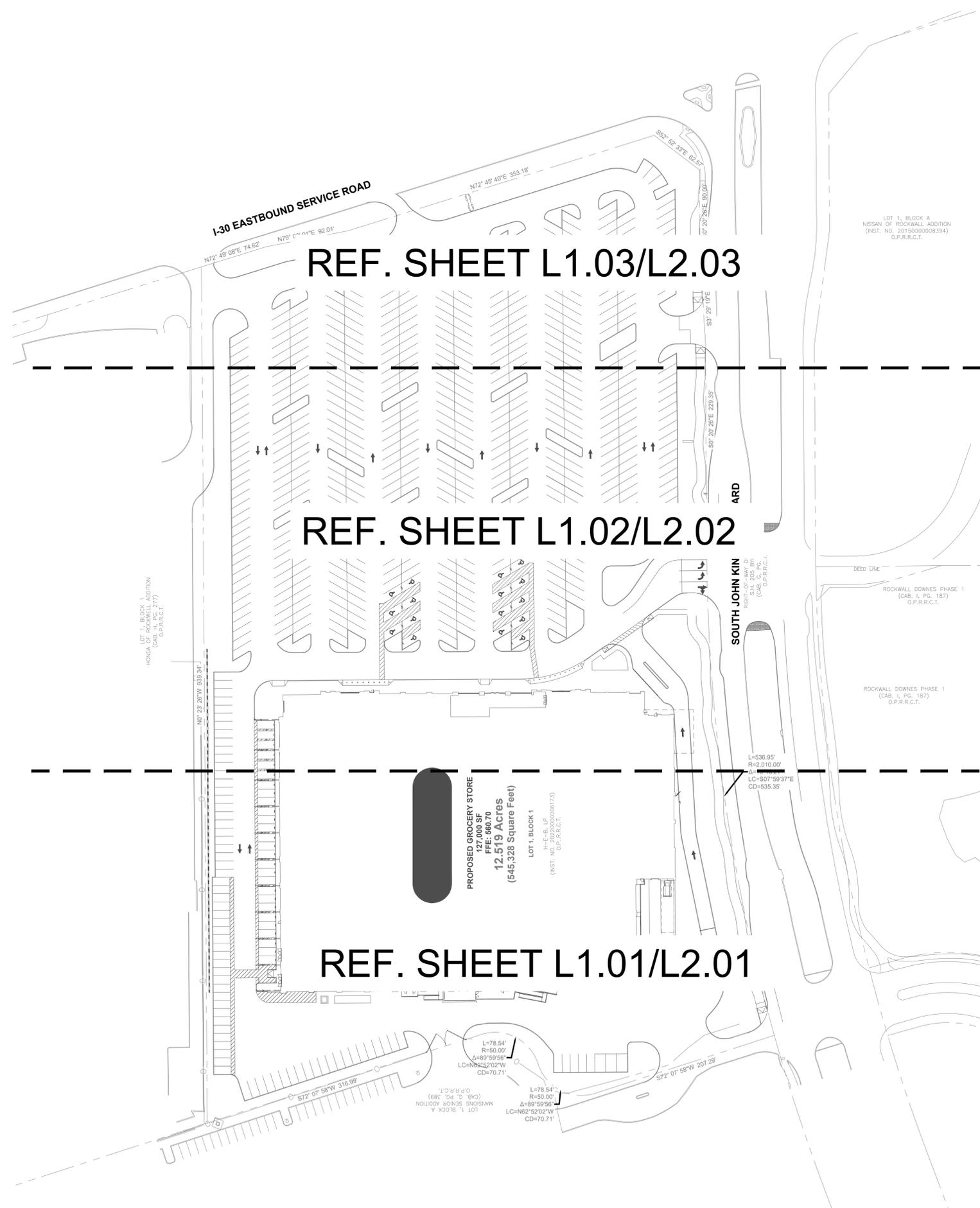

REF. SHEET L1.03/L2.03

REF. SHEET L1.02/L2.02

REF. SHEET L1.01/L2.01

PROPOSED GROCERY STORE
 127,000 SF
 FFE: 560.70
12.519 Acres
 (545,328 Square Feet)
 LOT 1, BLOCK 1
 (INST. NO. 2015000008394)
 O.P.R.R.C.T.

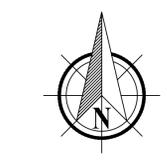
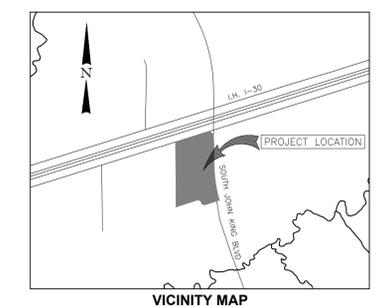

0 15' 30' 60' 120'
 SCALE: 1" = 60'



BGE, Inc.
 2595 Dallas Parkway, Suite 101
 Frisco, TX 75034
 Tel: 972-464-4800 • www.bgeinc.com
 TBPE Registration No. F-1046
 Copyright 2023

OWNER/DEVELOPER



646 S. FLORES ST.
 SAN ANTONIO, TX 78204
 TEL: (210) 938-4076
 CONTACT: LANCE KLEIN

LANDSCAPE ARCHITECT

BGE, INC.
 2595 DALLAS PKWY.,
 SUITE 101
 FRISCO, TX 75034
 CONTACT: MICHAEL
 STOTTLER, PLA
 PHONE: (972) 372-9381

OVERALL PLAN

H-E-B ROCKWALL

LOT 1, BLOCK 1

CITY OF ROCKWALL, ROCKWALL COUNTY, TEXAS

THESE PLANS ARE ISSUED FOR THE PURPOSE OF PRELIMINARY REVIEW AND ARE NOT INTENDED FOR CONSTRUCTION. WHEN ISSUED IN FINAL FORM THEY WILL BE SEALED, SIGNED AND DATED.

RESPONSIBLE LANDSCAPE ARCHITECT:
 MICHAEL STOTTLER, PLA
 TEXAS REGISTRATION NO. 3743
 BGE, INC.
 TEXAS REGISTERED ENGINEERING FIRM F-1046

December 15, 2023

!CAUTION !

Contractor to Verify exact location & Depth of Exist Facilities Prior to any Construction Activities

CAUTION !!!

CONTACT: 1-800-DIG-TESS
 48 HOURS PRIOR TO CONSTRUCTION

REVISIONS		
REV. NO.	DATE	DESCRIPTION

CHECKED BY: MLS
 DESIGNED BY: ACS
 DATE: December 13, 2023
 PROJECT NUMBER: 9559-01

SHEET NO
L0.03
 OVERALL PLAN

BGE, INC. THE DOCUMENT, TOGETHER WITH THE CONCEPTS AND DESIGNS PRESENTED HEREIN, AS AN INSTRUMENT OF SERVICE, IS INTENDED ONLY FOR THE SPECIFIC PURPOSE AND CLIENT FOR WHICH IT WAS PREPARED. REUSE OF AND IMPROPER RELIANCE ON THIS DOCUMENT WITHOUT WRITTEN AUTHORIZATION AND ADAPTATION BY BGE, INC. SHALL BE WITHOUT LIABILITY TO BGE, INC. © 2023 BGE, INC. ALL RIGHTS RESERVED. DATE: 12/13/2023. PROJECT: 2595 DALLAS PKWY. SHEET: L2.01-PLANTING PLAN. SCALE: 1"=30'. DRAWN BY: J. BROWN. CHECKED BY: M. L. S. DATE: 12/13/2023.

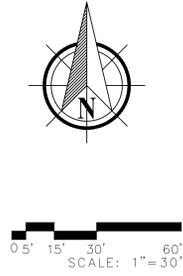
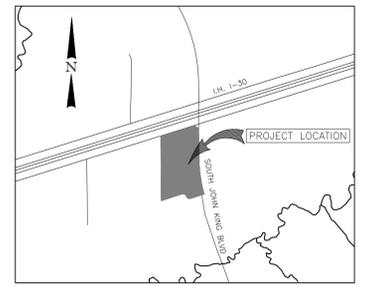
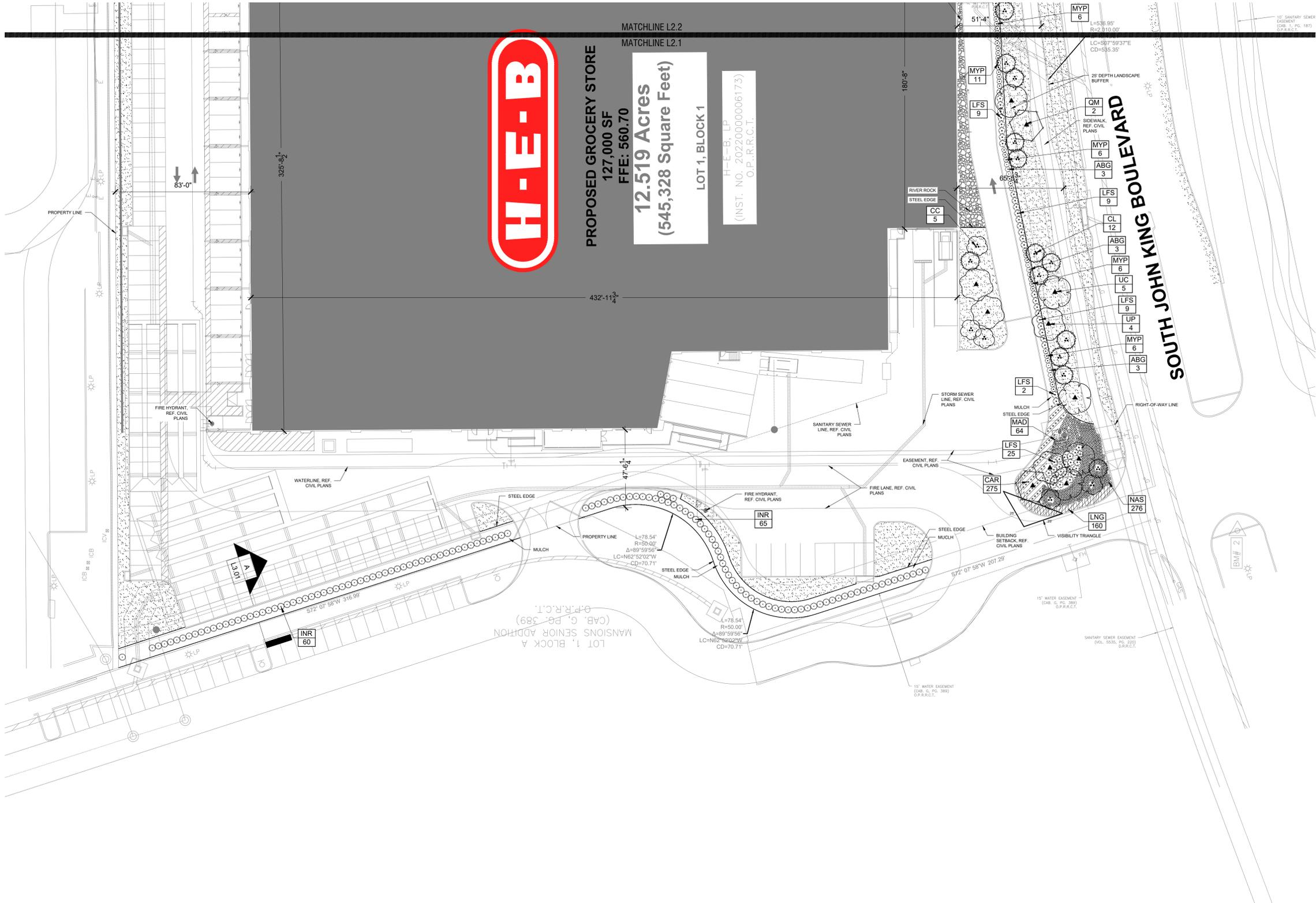

BGE, Inc.
 2595 Dallas Parkway, Suite 101
 Frisco, TX 75034
 Tel: 972-464-4800 • www.bgeinc.com
 TBPE Registration No. F-1046
 Copyright 2023

OWNER/DEVELOPER
H-E-B
 646 S. FLORES ST.
 SAN ANTONIO, TX 78204
 TEL: (210) 938-4076
 CONTACT: LANCE KLEIN

LANDSCAPE ARCHITECT
BGE, INC.
 2595 DALLAS PKWY.,
 SUITE 101
 FRISCO, TX 75034
 CONTACT: MICHAEL STOTTLER, PLA
 PHONE: (972) 372-9381

PLANTING PLAN

H-E-B ROCKWALL

LOT 1, BLOCK 1

CITY OF ROCKWALL, ROCKWALL COUNTY, TEXAS

THESE PLANS ARE ISSUED FOR THE PURPOSE OF PRELIMINARY REVIEW AND ARE NOT INTENDED FOR CONSTRUCTION. WHEN ISSUED IN FINAL FORM THEY WILL BE SEALED, SIGNED AND DATED.
 RESPONSIBLE LANDSCAPE ARCHITECT:
 MICHAEL STOTTLER, PLA
 TEXAS REGISTRATION NO. 3743
 BGE, INC.
 TEXAS REGISTERED ENGINEERING FIRM F-1046

!CAUTION !
 Contractor to Verify exact location & Depth of Exist Facilities Prior to any Construction Activities

CAUTION !!!
 CONTACT: 1-800-DIG-TESS
 48 HOURS PRIOR TO CONSTRUCTION

REVISIONS		
REV. NO.	DATE	DESCRIPTION

CHECKED BY: MLS
 DESIGNED BY: ACS
 DATE: December 13, 2023
 PROJECT NUMBER: 9559-01

SHEET NO
L2.01
 PLANTING PLAN

BGE, INC. C:\Users\jwagner\OneDrive\Documents\Projects\2023\12-13-2023\10-00am_0001\0001.dwg

THIS DOCUMENT, TOGETHER WITH THE CONCEPTS AND DESIGN PRESENTED HEREIN, IS AN INSTRUMENT OF SERVICE, IS INTENDED ONLY FOR THE SPECIFIC PURPOSE AND CLIENT FOR WHICH IT WAS PREPARED. REUSE OF AND IMPROPER RELIANCE ON THIS DOCUMENT WITHOUT WRITTEN AUTHORIZATION AND ADAPTATION BY BGE, INC. SHALL BE WITHOUT LIABILITY TO BGE, INC.

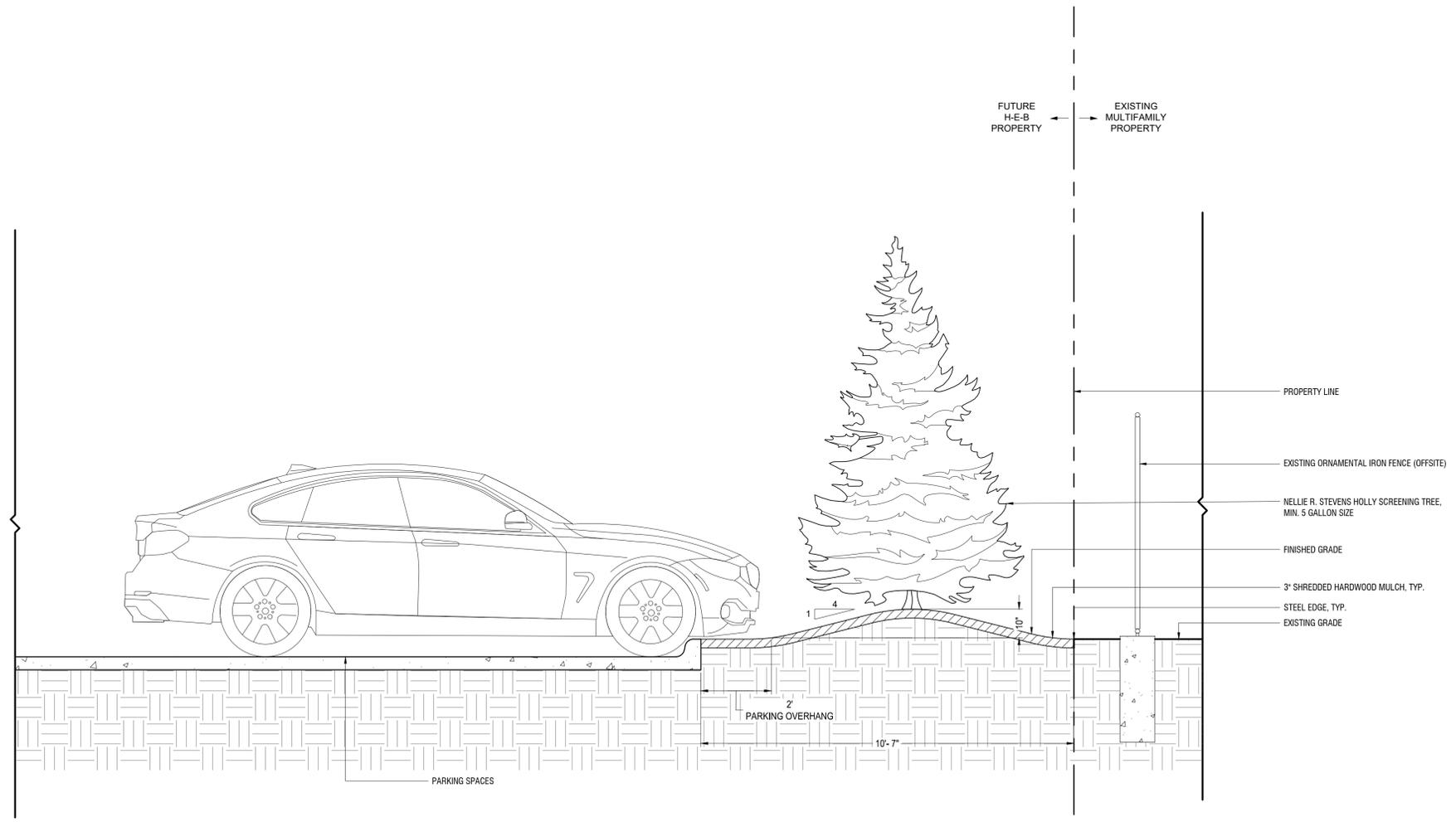

A H-E-B - REAR PARKING SCREENING
SECTION

SCALE: 6" = 1'-0"



BGE, Inc.
2595 Dallas Parkway, Suite 101
Frisco, TX 75034
Tel: 972-464-4800 • www.bgeinc.com
TBPE Registration No. F-1046
Copyright 2023

OWNER/DEVELOPER



646 S. FLORES ST.
SAN ANTONIO, TX 78204
TEL: (210) 938-4076
CONTACT: LANCE KLEIN

LANDSCAPE ARCHITECT

BGE, INC.
2595 DALLAS PKWY.,
SUITE 101
FRISCO, TX 75034
CONTACT: MICHAEL
STOTTLER, PLA
PHONE: (972) 372-9381

REAR SCREENING DETAIL

H-E-B ROCKWALL

LOT 1, BLOCK 1
CITY OF ROCKWALL, ROCKWALL COUNTY, TEXAS

THESE PLANS ARE ISSUED FOR THE PURPOSE OF PRELIMINARY REVIEW AND ARE NOT INTENDED FOR CONSTRUCTION. WHEN ISSUED IN FINAL FORM THEY WILL BE SEALED, SIGNED AND DATED.
RESPONSIBLE LANDSCAPE ARCHITECT:
MICHAEL STOTTLER, PLA
TEXAS REGISTRATION NO. 3743
BGE, INC.
TEXAS REGISTERED ENGINEERING FIRM F-1046
December 15, 2023

!CAUTION !
Contractor to Verify exact location & Depth of Exist Facilities Prior to any Construction Activities

CAUTION !!!
CONTACT: 1-800-DIG-TESS
48 HOURS PRIOR TO CONSTRUCTION

REVISIONS		
REV. NO.	DATE	DESCRIPTION

CHECKED BY: MLS
DESIGNED BY: ACS
DATE: December 13, 2023
PROJECT NUMBER: 9559-01

SHEET NO
L3.02
REAR SCREENING DETAIL

CITY OF ROCKWALL- CODE REQUIREMENTS

LANDSCAPE AREA	REQUIRED	PROVIDED
20% OF SITE 545,328 SF X 20% = 109,066 SF IMPERVIOUS AREA= 469,816 SF	109,066 SF 20%	76,310 SF 14%
SITE TREES	REQUIRED	PROVIDED
12 TREES PER ACRE 12.519 AC X 12 = 150.228 TREES	150 TREES	201 TREES
IH-30 OVERLAY DISTRICT	REQUIRED	PROVIDED
LANDSCAPE BUFFER 20' DEPTH	YES	YES
MIN. 30" HT SHRUBS	YES	YES
CANOPY TREES 2 TREES PER 100 LF (519.8 LF / 100) x 2 = 10 TREES	10 TREES	10 TREES
ORNAMENTAL TREES 4 TREE PER 100 LF (519.8 LF / 100) x 4 = 20 TREES	20 TREES	20 TREES
SH-205 BY-PASS OVERLAY DISTRICT	REQUIRED	PROVIDED
LANDSCAPE BUFFER 25' DEPTH	YES	YES
MIN. 30" HT SHRUBS	YES	YES
CANOPY TREES 2 TREE PER 100 LF (956.44 LF / 100) x 2 = 20 TREES	20 TREES	20 TREES
ORNAMENTAL TREES 4 TREE PER 100 LF (956.44 LF / 100) x 4 = 40 TREES	40 TREES	40 TREES
CEDAR TREES 1 TREE PER 100 LF 956.44 LF / 100 = 10 TREES	10 TREES	10 TREES
SCREENING FROM RESIDENTIAL	REQUIRED	PROVIDED
ORNAMENTAL IRON FENCE	YES	EXISTING
SCREENING SHRUBS	YES	YES
HEADLIGHT SCREENING	REQUIRED	PROVIDED
MIN. 2' HT BERM	YES	YES
EVERGREEN SHRUBS	YES	YES
PARKING REQUIREMENTS	REQUIRED	PROVIDED
MIN. 5 % INTERIOR LANDSCAPING TOTAL PARKING=136,099 SF	6,805 SF	8,641 SF
PARKING TREES 1 TREE PER 10 SPACES 673 SPACES / 10 = 67 TREES	67 TREES	67 TREES
TREE MITIGATION	REQUIRED	PROVIDED
TREE MITIGATION ONE 4" TREE PER 8' HT CEDAR REMOVED	59 TREES	59 TREES PROVIDED BY CODE REQUIRED TREES

PLANT SCHEDULE

CANOPY TREES	CODE	QTY	BOTANICAL NAME	COMMON NAME	SIZE	COND	HT	SPR	REMARKS
	QM	17	Quercus macrocarpa	Burr Oak	3" cal	14' ht	6' spr	B&B	Full, Straight, Single Leader
	QS	32	Quercus shumardii	Shumard Red Oak	3" cal	12' ht	5' spr	B&B	Full, Straight, Single Leader
	QV	8	Quercus virginiana	Southern Live Oak	3" cal	12' ht	6' spr	B&B	Full, Straight, Single Leader
	UC	33	Ulmus crassifolia	Cedar Elm	3" cal	14' ht	5' spr	B&B	Full, Straight, Single Leader
	UP	17	Ulmus parvifolia 'Allee'	Allee Lacebark Elm	3" cal	14' ht	6' spr	B&B	Full, Straight, Single Leader
ORNAMENTAL TREES	CODE	QTY	BOTANICAL NAME	COMMON NAME	SIZE	COND	HT	SPR	REMARKS
	CC	23	Cercis canadensis	Eastern Redbud	2" cal	8' ht	4' spr	B&B	Full, Multi-Trunk
	CL	37	Chilopsis linearis	Desert Willow	2" cal	6' ht	4' spr	30 gal	Full, Multi-Trunk
SHRUBS	CODE	QTY	BOTANICAL NAME	COMMON NAME	SIZE	COND	HT	SPR	REMARKS
	ABG	29	Abelia x grandiflora	Glossy Abelia	18" ht	18" spr	36" oc	3 gal	Full, Matching
	INR	125	Ilex x 'Nellie R. Stevens'	Nellie R. Stevens Holly	30" ht	24" spr	48" oc	5 gal	Full, Matching
	LFS	179	Leucophyllum frutescens	Texas Sage	36" ht	24" spr	48" oc	5 gal	Full, Matching
	MAD	64	Malvaviscus drummondii	Turk's Cap	24" ht	18" spr	24" oc	3 gal	Full, Matching
	MYP	147	Myrica pusilla	Dwarf Wax Myrtle	24" ht	18" spr	36" oc	3 gal	Full, Matching
GRASSES	CODE	QTY	BOTANICAL NAME	COMMON NAME	SIZE	COND	HT	SPR	REMARKS
	NAS	276	Nassella tenuissima	Mexican Feather Grass	18" ht	---	24" oc	3 gal	Full, Matching
GROUND COVER	CODE	QTY	BOTANICAL NAME	COMMON NAME	SIZE	COND	HT	SPR	REMARKS
	CAR	275	Carex divulsa	Berkeley Sedge	12" ht	12" spr	18" oc	1 gal	Full, 1 gallon min.
	LNG	160	Lantana x 'New Gold'	New Gold Lantana	12" ht	12" spr	18" oc	1 gal	Full, 1 gallon min.
SOD	CODE	QTY	BOTANICAL NAME	COMMON NAME	SIZE	COND	HT	SPR	REMARKS
	SOD	65,518 sf	Cynodon dactylon	Common Bermuda Grass	---	---	---	---	Solid Sod, tight sand filled joints, 100% weed, disease and pest free
GROUND COVER	CODE	QTY	BOTANICAL NAME	COMMON NAME	SIZE	COND	HT	SPR	REMARKS
	STEEL EDGE	TBD		Steel Edging					3/8" x 6", black
	MULCH	TBD		Shredded Hardwood Mulch					Min. 3" depth, trees in sod to receive 4' dia ring
	RIVER ROCK	TBD		River Rock					2"-4" size, natural color

IRRIGATION NOTE:
ALL PLANT MATERIAL TO BE IRRIGATED IN COMPLIANCE TO CITY OF ROCKWALL, UNIFIED DEVELOPMENT CODE ARTICLE 8.05.04



BGE, Inc.
2595 Dallas Parkway, Suite 101
Frisco, TX 75034
Tel: 972-464-4800 • www.bgeinc.com
TBPE Registration No. F-1046
Copyright 2023

OWNER/DEVELOPER



646 S. FLORES ST.
SAN ANTONIO, TX 78204
TEL: (210) 938-4076
CONTACT: LANCE KLEIN

LANDSCAPE ARCHITECT

BGE, INC.
2595 DALLAS PKWY.,
SUITE 101
FRISCO, TX 75034
CONTACT: MICHAEL
STOTTLER, PLA
PHONE: (972) 372-9381

PLANTING SCHEDULE & TABULATIONS

H-E-B ROCKWALL

LOT 1, BLOCK 1
CITY OF ROCKWALL, ROCKWALL COUNTY, TEXAS

THESE PLANS ARE ISSUED FOR THE PURPOSE OF PRELIMINARY REVIEW AND ARE NOT INTENDED FOR CONSTRUCTION. WHEN ISSUED IN FINAL FORM THEY WILL BE SEALED, SIGNED AND DATED.
RESPONSIBLE LANDSCAPE ARCHITECT:
MICHAEL STOTTLER, PLA
TEXAS REGISTRATION NO. 3743
BGE, INC.
TEXAS REGISTERED ENGINEERING FIRM F-1046

!CAUTION !!
Contractor to Verify exact location & Depth of Exist Facilities Prior to any Construction Activities

CAUTION !!!
CONTACT: 1-800-DIG-TESS
48 HOURS PRIOR TO CONSTRUCTION

REVISIONS		
REV. NO.	DATE	DESCRIPTION

CHECKED BY: MLS
DESIGNED BY: ACS
DATE: December 13, 2023
PROJECT NUMBER: 9559-01

SHEET NO
L2.00
PLANTING SCHEDULE & TABULATIONS

BGE, INC. THE DOCUMENT, TOGETHER WITH THE CONCEPTS AND DESIGN PRESENTED HEREIN, AS AN INSTRUMENT OF SERVICE, IS INTENDED ONLY FOR THE SPECIFIC PURPOSE AND CLIENT FOR WHICH IT WAS PREPARED. REUSE OF AND IMPROPER RELIANCE ON THIS DOCUMENT WITHOUT WRITTEN AUTHORIZATION AND ADAPTATION BY BGE, INC. SHALL BE WITHOUT LIABILITY TO BGE, INC. © 2023 BGE, INC. ALL RIGHTS RESERVED. DATE: 12/13/2023. PROJECT: 9559-01. SHEET: L2.00. DRAWING: PLANTING SCHEDULE & TABULATIONS.

GENERAL LANDSCAPE SPECIFICATIONS AND NOTES

A. SCOPE OF WORK

- 1. THE WORK CONSISTS OF FURNISHING ALL LABOR, MATERIALS, EQUIPMENT, TOOLS, TRANSPORTATION, AND ANY OTHER APPURTENANCES NECESSARY FOR THE COMPLETION OF THIS PROJECT AS SHOWN ON THE DRAWINGS, AS INCLUDED IN THE PLANT LIST, AND AS HEREIN SPECIFIED.
2. WORK SHALL INCLUDE MAINTENANCE AND WATERING OF ALL PLANTING AREAS OF THIS CONTRACT UNTIL CERTIFICATION OF ACCEPTABILITY BY THE OWNER.

B. PROTECTION OF EXISTING STRUCTURES

ALL EXISTING BUILDINGS, WALKS, WALLS, PAVING, PIPING, AND OTHER ITEMS OF CONSTRUCTION AND PLANTING ALREADY COMPLETED OR ESTABLISHED SHALL BE PROTECTED FROM DAMAGE BY THIS CONTRACTOR UNLESS OTHERWISE SPECIFIED. ALL DAMAGE RESULTING FROM NEGLIGENCE SHALL BE REPAIRED OR REPLACED TO THE SATISFACTION OF THE OWNER.

C. PROTECTION OF EXISTING PLANT MATERIALS OUTSIDE LIMIT OF WORK

THE CONTRACTOR SHALL BE RESPONSIBLE FOR ALL UNAUTHORIZED CUTTING OR DAMAGE OF TREES AND SHRUBS EXISTING OR OTHERWISE, CAUSED BY CARELESS OPERATION OF EQUIPMENT, STOCKPIILING OF MATERIALS, ETC. THIS SHALL INCLUDE COMPACTION BY DRIVING OR PARKING INSIDE THE DRIP-LINE OR THE SPILLING OF OIL, GASOLINE, OR OTHER DELETERIOUS MATERIALS WITHIN THE DRIP-LINE. NO MATERIALS SHALL BE BURNED WHERE THE HEAT WILL DAMAGE ANY PLANT. TREES KILLED OR DAMAGED SO THAT THEY ARE MISSHAPE AND/OR UNSIGHTLY SHALL BE REPLACED AT THE COST TO THE CONTRACTOR OF TWO HUNDRED DOLLARS (\$200) PER CALIPER INCH ON AN ESCALATING SCALE WHICH ADDS AN ADDITIONAL TWENTY (20) PERCENT PER INCH OVER FOUR (4) INCHES CALIPER AS FIXED AND AGREED LIQUIDATED DAMAGES. CALIPER SHALL BE MEASURED AT SIX (6) INCHES ABOVE GROUND LEVEL FOR TREES UP TO AND INCLUDING FOUR (4) INCHES IN CALIPER AND AT TWELVE (12) INCHES ABOVE GROUND LEVEL FOR TREES OVER FOUR (4) INCHES IN CALIPER.

D. MATERIALS

1. GENERAL

SAMPLES OF MATERIALS AS LISTED BELOW SHALL BE SUBMITTED FOR APPROVAL, ON THE SITE OR AS OTHERWISE DETERMINED BY THE OWNER. UPON APPROVAL OF SAMPLES, DELIVERY OF MATERIALS MAY BEGIN.

Table with 2 columns: MATERIALS, SAMPLES. Includes Mulch (1 cubic foot), Topsoil (1 cubic yard), and Plants (1 of each variety).

2. PLANT MATERIALS

A. PLANT SPECIES AND SIZE SHALL CONFORM TO THOSE INDICATED ON THE DRAWINGS. NOMENCLATURE SHALL CONFORM TO "STANDARDIZED PLANT NAMES", 1942 EDITION. ALL NURSERY STOCK SHALL BE IN ACCORDANCE WITH GRADES AND STANDARDS AS STATED IN THE LATEST EDITION OF "AMERICAN STANDARD FOR NURSERY STOCK" BY THE AMERICAN ASSOCIATION OF NURSERYMEN. ALL PLANTS SHALL BE FRESHLY DUG, SOUND, HEALTHY, VIGOROUS, WELL-BRANCHED AND FREE OF DISEASE AND INSECTS. INSECT EGGS AND LARVAE AND SHALL HAVE AN INTEGRAL ROOT SYSTEMS. TREES FOR PLANTING IN ROWS SHALL BE UNIFORM IN SIZE AND SHAPE. ALL MATERIALS SHALL BE SUBJECT TO APPROVAL BY THE OWNER. WHERE ANY REQUIREMENTS ARE OMITTED FROM THE PLANT LIST, THE PLANTS FURNISHED SHALL BE NORMAL FOR THE VARIETY. PLANTS SHALL BE PRUNED PRIOR TO DELIVERY ONLY UPON THE APPROVAL OF THE OWNER.

B. MEASUREMENTS: THE HEIGHT AND/OR WIDTH OF TREES SHALL BE MEASURED FROM THE GROUND OR ACROSS THE NORMAL SPREAD OF BRANCHES WITH THE PLANTS IN THEIR NORMAL POSITION. THIS MEASUREMENT SHALL NOT INCLUDE THE IMMEDIATE TERMINAL GROWTH. PLANTS LARGER IN SIZE THAN THOSE SPECIFIED IN THE PLANT LIST MAY BE USED IF APPROVED BY THE OWNER. IF THE USE OF LARGER PLANTS IS APPROVED, THE BALL OF EARTH OR SPREAD OF ROOTS SHALL BE INCREASED IN PROPORTION TO THE SIZE OF THE PLANT.

C. INSPECTION: PLANTS SHALL BE SUBJECT TO INSPECTION AND APPROVAL AT THE PLACE OF GROWTH, OR UPON DELIVERY TO THE SITE, AS DETERMINED BY THE OWNER, FOR QUALITY, SIZE, AND VARIETY. SUCH APPROVAL SHALL NOT IMPAIR THE RIGHT OF INSPECTION AND REJECTION AT THE SITE DURING PROGRESS OF THE WORK OR AFTER COMPLETION FOR SIZE AND GROUND ROOT SYSTEMS OR ROOTS, LATENT DEFECTS OR INJURIES. REJECTED PLANTS SHALL BE REMOVED IMMEDIATELY FROM THE SITE. NOTICE REQUESTING INSPECTION SHALL BE SUBMITTED IN WRITING BY THE CONTRACTOR AT LEAST ONE (1) WEEK PRIOR TO ANTICIPATED DATE.

E. TOPSOIL

- 1. ASTM D5268, NATURAL, FRIABLE, FERTILE, FINE LOAMY SOIL POSSESSING CHARACTERISTICS OF REPRESENTATIVE TOPSOIL IN THE VICINITY THAT PRODUCES HEAVY GROWTH. TOPSOIL SHALL HAVE A PH RANGE OF 5.5 TO 7.4 PERCENT, FREE FROM SUBSOIL, OBJECTIONABLE WEEDS, LITTER, SODS, STIFF CLAY, STONES LARGER THAN 1-INCH IN DIAMETER, STUMPS, ROOTS, TRASH, HERBICIDES, TOXIC SUBSTANCES, OR ANY OTHER MATERIAL WHICH MAY BE HARMFUL TO PLANT GROWTH OR HINDER PLANTING OPERATIONS. TOP SOIL SHALL CONTAIN A MINIMUM OF THREE PERCENT ORGANIC MATERIAL.
2. SALVAGED OR EXISTING TOPSOIL: REUSE SUITABLE TOPSOIL STOCKPILED ON-SITE OR EXISTING TOPSOIL UNDISTURBED BY GRADING OR EXCAVATION OPERATIONS. CLEAN TOPSOIL OF ROOTS, PLANTS, SOD, STONES, CLAY LUMPS, AND OTHER EXTRANEOUS MATERIALS HARMFUL TO PLANT GROWTH.
3. VERIFY AMOUNT OF SUITABLE TOPSOIL STOCKPILED IF ANY, AND SUPPLY ADDITIONAL IMPORTED TOPSOIL AS NEEDED. FOUR (4) INCHES OF TOPSOIL TO BE PROVIDED FOR ALL PLANTING AREAS WITHIN TWENTY FOUR (24) INCHES OF TOPSOIL TO BE PROVIDED FOR ALL PLANTING AREAS WITHIN INTERIOR LANDSCAPE ISLANDS AND FOUNDATION PLANTINGS. FOR ALL OTHER PLANTING AREAS, TWELVE (12) INCHES OF TOPSOIL MINIMUM TO BE PROVIDED.
4. IMPORTED TOPSOIL: SUPPLEMENT SALVAGED TOPSOIL WITH IMPORTED TOPSOIL FROM OFF-SITE SOURCES WHEN EXISTING QUANTITIES ARE INSUFFICIENT.
5. OBTAIN TOPSOIL DISPLACED FROM NATURALLY WELL-DRAINED SITES WHERE TOPSOIL OCCURS AT LEAST 6 INCHES DEEP. DO NOT OBTAIN FROM AGRICULTURAL LAND, BOGS, OR MARSHES.
6. VERIFY BORROW AND DISPOSAL SITES ARE PERMITTED AS REQUIRED BY STATE AND LOCAL REGULATIONS. OBTAIN WRITTEN CONFIRMATION THAT PERMITS ARE CURRENT AND ACTIVE.
7. OBTAIN PERMITS REQUIRED BY STATE AND LOCAL REGULATIONS FOR TRANSPORTING TOPSOIL. PERMITS SHALL BE CURRENT AND ACTIVE.
8. AMEND EXISTING AND IMPORTED TOPSOIL AS INDICATED BELOW.

a. ORGANIC SOIL AMENDMENTS

- 1. MANURE: WELL-ROTTED, UNLEACHED, STABLE OR CATTLE MANURE CONTAINING NOT MORE THAN 25 PERCENT BY VOLUME OF STRAW, SAWDUST, OR OTHER BEDDING MATERIALS; FREE OF TOXIC SUBSTANCES, STONES, STICKS, SOIL, WEED SEED, AND MATERIAL HARMFUL TO PLANT GROWTH.
2. BACK TO NATURE COTTON BURR COMPOST OR APPROVED EQUIVALENT.
3. COMPOST: DECOMPOSED ORGANIC MATERIAL INCLUDING LEAF LITTER, MANURE, SAWDUST, PLANT TRIMMINGS AND/OR HAY, MIXED WITH SOIL.
4. PECAN HULLS: COMPOSTED PECAN HULLS FROM LOCAL SOURCE.
5. BIOSOLIDS: USE GRADE 1 CONTAINING LOWER PATHOGEN LEVELS.
6. WORM CASTINGS: EARTHWORMS.

b. INORGANIC SOIL AMENDMENTS

- 1. LIME: ASTM C602, CLASS A AGRICULTURAL LIMESTONE CONTAINING A MINIMUM OF 80 PERCENT CALCIUM CARBONATE EQUIVALENT WITH A MINIMUM OF 95 PERCENT PASSING NO. 8 SIEVE AND MINIMUM OF 55 PERCENT PASSING NO. 60 SIEVE.
2. SULFUR: GRANULAR, BIODEGRADABLE, CONTAINING A MINIMUM OF 90 PERCENT SULFUR, WITH A MINIMUM OF 99 PERCENT PASSING NO. 6 SIEVE AND A MAXIMUM OF 10 PERCENT PASSING NO. 40 SIEVE.
3. IRON SULFATE: GRANULATED FERROUS SULFATE CONTAINING A MINIMUM OF 20 PERCENT IRON AND 10 PERCENT SULFUR.
4. AGRICULTURAL GYPSUM: FINELY GROUND, CONTAINING A MINIMUM OF 90 PERCENT CALCIUM SULFATE.
5. SAND: CLEAN, WASHED, NATURAL OR MANUFACTURED, FREE OF TOXIC MATERIALS.

c. ELEMENTS MIX

- 1. PLANTING MIX MAY BE PROVIDED BY LIVING EARTH OR MINICK MATERIALS OR APPROVED EQUAL.
2. PLANTING MEDIUM CONTAINING 75 PERCENT SPECIFIED TOPSOIL MIXED WITH 15 PERCENT ORGANIC SOIL AMENDMENTS AND 10 PERCENT SHARP WASHED SAND, TILL TO DEPTH OF 12" OR AS OTHERWISE NOTED. FINISHED GRADES OF PLANTING BEDS TO BE 2" BELOW FINISHED GRADE OF ADJACENT PAVING OR AS SHOWN ON GRADING PLAN.
2. SOD/SEED AREA TOPSOIL
ALL SOD AREAS TO RECEIVE 4" DEPTH (MIN) TOPSOIL PRIOR TO INSTALLATION. TOPSOIL SHALL BE NATURAL, FRIABLE, FERTILE, WITH 25% (MIN.) ORGANIC MATERIAL, AND FREE OF TRASH, DEBRIS, STONES, WEEDS, AND TWIGS/BRANCHES. THE PARTICLE SIZES SHALL BE SUCH THAT 98.5% OF THE TOPSOIL WILL PASS THROUGH A 1/2 INCH SCREEN, AND 99% MORE SHALL PASS THROUGH A 3/4 INCH SCREEN. TOPSOIL SHALL BE REVIEWED/APPROVED BY OWNER/LANDSCAPE ARCHITECT PRIOR TO INSTALLATION. CONTRACTOR TO SUBMIT SAMPLES IN 1 GAL (MIN.) CONTAINER.

I. WATER

WATER NECESSARY FOR PLANTING AND MAINTENANCE SHALL BE OF SATISFACTORY QUALITY TO SUSTAIN AN ADEQUATE GROWTH OF PLANTS AND SHALL NOT CONTAIN HARMFUL, NATURAL OR MAN-MADE ELEMENTS DETRIMENTAL TO PLANTS. WATER MEETING THE ABOVE STANDARD SHALL BE OBTAINED ON THE SITE FROM THE OWNER, IF AVAILABLE, AND THE CONTRACTOR SHALL BE RESPONSIBLE TO MAKE ARRANGEMENTS FOR ITS USE BY TANKS, HOSES, SPRINKLERS, ETC. IF SUCH WATER IS NOT AVAILABLE AT THE SITE, THE CONTRACTOR SHALL PROVIDE SUCH SATISFACTORY WATER FROM SOURCES OFF THE SITE AT NO ADDITIONAL COST TO THE OWNER.

J. COMMERCIAL FERTILIZER

COMMERCIAL FERTILIZER SHALL BE A COMPLETE FORMULA; IT SHALL BE UNIFORM IN COMPOSITION, DRY AND FREE FLOWING. THIS FERTILIZER SHALL BE DELIVERED TO THE SITE IN THE ORIGINAL UNOPENED CONTAINERS, EACH BEARING THE MANUFACTURER'S GUARANTEED STATEMENT OF ANALYSIS.

FIFTY PERCENT (50%) OF THE NITROGEN SHALL BE DERIVED FROM NATURAL ORGANIC SOURCES. THE FOLLOWING FERTILIZERS SHALL BE USED AND APPLIED AT RATES AS SUGGESTED BY MANUFACTURER'S SPECIFICATIONS:

- 1. SHRUBS AND TREES - SUSTANE BLEND 16-4-8, OR APPROVED EQUAL
2. ANNUALS AND GROUNDCOVERS - OSMOCOTE/SIERRA BLEND 14-14-14 OR APPROVED EQUAL
3. SOD - 8-8-8 FERTILIZER OR APPROVED EQUAL

K. MULCH

MULCH MATERIAL SHALL BE MOISTENED AT THE TIME OF APPLICATION TO PREVENT WIND DISPLACEMENT, AND APPLIED AT A DEPTH OF 3 INCHES. SEE PLANT LIST FOR TYPE OF MATERIAL AND GRADE.

L. DIGGING AND HANDLING

- 1. PROTECT ROOTS OR BALLS OF PLANTS AT ALL TIMES FROM SUN AND DRYING WINDS, WATER AND FREEZING, AS NECESSARY UNTIL PLANTING. PLANT MATERIALS SHALL BE ADEQUATELY PACKED TO PREVENT BREAKAGE AND DRYING OUT DURING TRANSIT. TREES TRANSPORTED MORE THAN TEN (10) MILES OR WHICH ARE NOT PLANTED WITHIN THREE (3) DAYS OF DELIVERY TO SITE SHALL BE SPRAYED WITH AN ANTI-TRANSPIRANT PRODUCT ("WILT-PRUF" OR EQUAL) TO MINIMIZE TRANSPIRATIONAL WATER LOSS.
2. BALLED AND BURLAPPED PLANTS (B&B) SHALL BE DUG WITH FIRM, NATURAL BALLS OF SOIL OF SUFFICIENT SIZE TO ENCOMPASS THE FIBROUS AND FEEDING ROOTS OF THE PLANTS. NO PLANTS MOVED WITH A BALL SHALL BE PLANTED IF THE BALL IS CRACKED OR BROKEN. PLANTS BALLED AND BURLAPPED OR CONTAINER GROWN SHALL NOT BE HANDLED BY STEMS.
3. PLANTS MARKED "BR" IN THE PLANT LIST SHALL BE DUG WITH BARE ROOTS. THE ROOTS SHALL NOT BE CUT WITHIN THE MINIMUM SPREAD SPECIFIED IN THE PLANT LIST. CARE SHALL BE EXERCISED THAT THE ROOTS DO NOT DRY OUT IN MOVING AND PRIOR TO PLANTING.
4. PROTECTION OF PALMS (IF APPLICABLE): ONLY A MINIMUM OF FRONDS SHALL BE REMOVED FROM THE CROWN OF THE PALM TREES TO FACILITATE MOVING AND HANDLING. CLEAR TRUNK (CT) SHALL BE AS SPECIFIED AFTER THE MINIMUM OF FRONDS HAVE BEEN REMOVED. ALL PALMS SHALL BE BRACED PER DETAIL.
5. EXCAVATION OF TREE PITS SHALL BE DONE USING EXTREME CARE TO AVOID DAMAGE TO SURFACE AND SUBSURFACE ELEMENTS SUCH AS UTILITIES OR HARDSCAPE ELEMENTS, FOOTERS AND PREPARED SUB-BASES.

M. CONTAINER GROWN STOCK

- 1. ALL CONTAINER GROWN MATERIAL SHALL BE HEALTHY, VIGOROUS, WELL-ROOTED PLANTS AND ESTABLISHED IN THE CONTAINER IN WHICH THEY ARE SOLD. THE PLANTS SHALL HAVE TOPS WHICH ARE OF GOOD QUALITY AND ARE IN A HEALTHY GROWING CONDITION.
2. AN ESTABLISHED CONTAINER GROWN PLANT SHALL BE TRANSLANTED INTO A CONTAINER AND GROWN IN THAT CONTAINER SUFFICIENTLY LONG FOR THE NEW FIBROUS ROOTS TO HAVE DEVELOPED SO THAT THE ROOT MASS WILL RETAIN ITS SHAPE AND HOLD TOGETHER WHEN REMOVED FROM THE CONTAINER. CONTAINER GROWN STOCK SHALL NOT BE HANDLED BY THEIR STEMS.
3. PLANT ROOTS BOUND IN CONTAINERS SHALL NOT BE ACCEPTABLE.
4. SUBSTITUTION OF NON-CONTAINER GROWN MATERIAL FOR MATERIAL EXPLICITLY SPECIFIED TO BE CONTAINER GROWN WILL NOT BE PERMITTED UNLESS WRITTEN APPROVAL IS OBTAINED FROM THE OWNER AND LANDSCAPE ARCHITECT.

N. COLLECTED STOCK

WHEN THE USE OF COLLECTED STOCK IS PERMITTED AS INDICATED ON THE PLANT LIST SCHEDULE, THE MINIMUM SIZES OF ROOTBALLS SHALL BE EQUAL TO THAT SPECIFIED FOR THE NEXT LARGER SIZE OF NURSERY GROWN STOCK OF THE SAME VARIETY.

O. NATIVE STOCK

PLANTS COLLECTED FROM WILD OR NATIVE STANDS SHALL BE CONSIDERED NURSERY GROWN WHEN THEY HAVE BEEN SUCCESSFULLY REESTABLISHED IN A NURSERY ROW AND GROWN UNDER REGULAR NURSERY CULTURAL PRACTICES FOR A MINIMUM OF TWO (2) GROWING SEASONS AND HAVE ATTAINED ADEQUATE ROOT AND TOP GROWTH TO INDICATE FULL RECOVERY FROM TRANSPANTING INTO THE NURSERY ROW.

P. MATERIALS LIST

QUANTITIES NECESSARY TO COMPLETE THE WORK ON THE DRAWINGS SHALL BE FURNISHED BY THE CONTRACTOR. QUANTITY ESTIMATES HAVE BEEN MADE CAREFULLY, BUT THE LANDSCAPE ARCHITECT OR OWNER ASSUMES NO LIABILITY FOR OMISSIONS OR ERRORS. SHOULD A DISCREPANCY OCCUR BETWEEN THE BIDDERS TAKE OFF AND THE PLANT LIST QUANTITY, THE LANDSCAPE ARCHITECT SHALL BE NOTIFIED FOR CLARIFICATION PRIOR TO THE SUBMISSIONS OF BIDS. ALL DIMENSIONS AND/OR SIZES SPECIFIED SHALL BE THE MINIMUM ACCEPTABLE SIZE

Q. FINE GRADING

- 1. FINE GRADING UNDER THIS CONTRACT SHALL CONSIST OF FINAL FINISHED GRADING OF LAWN AND PLANTING AREAS THAT HAVE BEEN ROUGH GRADED BY OTHERS. BERMING AS SHOWN ON THE DRAWINGS SHALL BE THE RESPONSIBILITY OF THE LANDSCAPE CONTRACTOR, UNLESS OTHERWISE NOTED.
2. THE LANDSCAPE CONTRACTOR SHALL FINE GRADE THE LAWN AND PLANTING AREAS TO BRING THE ROUGH GRADE UP TO FINAL FINISHED GRADE ALLOWING FOR THICKNESS OF SOD AND/OR MULCH DEPTH. THIS CONTRACTOR SHALL FINE GRADE BY HAND AND/OR WITH ALL EQUIPMENT NECESSARY INCLUDING A GRADING TRACTOR WITH FRONT-END LOADER FOR TRANSPORTING SOIL WITHIN THE SITE.
3. ALL PLANTING AREAS SHALL BE GRADED AND MAINTAINED TO ALLOW FREE FLOW OF SURFACE WATER. AREAS ADJACENT TO BUILDINGS SHALL SLOPE AWAY FROM THE BUILDINGS.

R. PLANTING PROCEDURES

- 1. CLEANING UP BEFORE COMMENCING WORK: THE CONTRACTOR SHALL CLEAN UP JOB SITE AND SURROUNDING AREAS OF ALL RUBBISH OR OBJECTIONABLE MATTER. ALL MORTAR, CEMENT, AND TOXIC MATERIAL SHALL BE REMOVED FROM THE SURFACE OF ALL PLANT BEDS. THESE MATERIALS SHALL NOT BE MIXED WITH THE SOIL. SHOULD THE CONTRACTOR FIND SUCH CONDITIONS DURING EXCAVATION WHICH WILL IN ANY WAY ADVERSELY AFFECT THE PLANT GROWTH, HE SHALL IMMEDIATELY CALL IT TO THE ATTENTION OF THE LANDSCAPE ARCHITECT OR OWNER. FAILURE TO DO SO BEFORE PLANTING SHALL MAKE THE CORRECTIVE MEASURES THE RESPONSIBILITY OF THE CONTRACTOR.
2. VERIFY LOCATIONS OF ALL UTILITIES, CONDUITS, SUPPLY LINES AND CABLES, INCLUDING BUT NOT LIMITED TO: ELECTRIC, GAS (LINES AND TANKS), WATER, SANITARY SEWER, STORMWATER LINES, CABLE AND TELEPHONE. PROPERLY MAINTAIN AND PROTECT EXISTING UTILITIES.
3. SUBGRADE EXCAVATION: SITE CONTRACTOR IS RESPONSIBLE TO REMOVE ALL EXISTING AND IMPORTED LIMEROCK AND LIMEROCK SUB-BASE FROM ALL LANDSCAPE PLANTING AREAS TO A MINIMUM DEPTH OF 36". SITE CONTRACTOR IS RESPONSIBLE TO BACKFILL THESE PLANTING AREAS TO ROUGH FINISHED GRADE WITH CLEAN TOPSOIL FROM AN ON-SITE SOURCE OR AN IMPORTED SOURCE. IF LIMEROCK OR OTHER ADVERSE CONDITIONS OCCUR IN PLANTED AREAS AFTER 36" DEEP EXCAVATION BY SITE CONTRACTOR, AND POSITIVE DRAINAGE CAN NOT BE ACHIEVED, LANDSCAPE CONTRACTOR SHALL CONTACT LANDSCAPE ARCHITECT OR OWNER.
4. FURNISH NURSERY'S CERTIFICATE OF COMPLIANCE WITH ALL REQUIREMENTS AS HEREIN SPECIFIED AND REQUIRED. INSPECT AND SELECT PLANT MATERIALS BEFORE PLANTS ARE DUG AT NURSERY OR GROWING SITE.

5. GENERAL: COMPLY WITH APPLICABLE FEDERAL, STATE, COUNTY, AND LOCAL REGULATIONS GOVERNING LANDSCAPE MATERIALS AND WORK. CONFORM TO ACCEPTED HORTICULTURAL PRACTICES AS USED IN THE TRADE. PLANTS SHALL BE PROTECTED UPON ARRIVAL AT THE SITE BY BEING THOROUGHLY WATERED AND PROPERLY MAINTAINED UNTIL PLANTED. PLANTS SHALL NOT REMAIN UNPROTECTED FOR A PERIOD EXCEEDING TWENTY-FOUR (24) HOURS. AT ALL TIMES WORKMANLIKE METHODS CUSTOMARY IN GOOD HORTICULTURAL PRACTICES SHALL BE EXERCISED.

6. THE WORK SHALL BE COORDINATED WITH OTHER TRADES TO PREVENT CONFLICTS. COORDINATE THE PLANTING WITH THE IRRIGATION WORK TO ASSURE AVAILABILITY OF WATER AND PROPER LOCATION OF IRRIGATION ITEMS AND PLANTS.

7. ALL PLANTING PITS SHALL BE EXCAVATED TO SIZE AND DEPTH IN ACCORDANCE WITH THE USA STANDARD FOR NURSERY STOCK 260.1, UNLESS SHOWN OTHERWISE ON THE DRAWINGS, AND BACKFILLED WITH THE PREPARED PLANTING SOIL AS SPECIFIED HEREIN BEFORE (SECTION H). TEST ALL TREE PITS WITH WATER BEFORE PLANTING TO ASSURE PROPER PERCOLATION IS AVAILABLE. NO ALLOWANCE WILL BE MADE FOR LOST PLANTS DUE TO IMPROPER DRAINAGE. IF POOR DRAINAGE EXISTS, UTILIZE PLANTING DETAIL THAT ADDRESSES THIS CONDITION. TREES SHALL BE SET PLUMB AND HELD IN POSITION UNTIL THE PLANTING MIXTURE HAS BEEN FLUSHED INTO PLACE WITH A SLOW, FULL HOSE STREAM. ALL PLANTING SHALL BE PERFORMED BY PERSONNEL FAMILIAR WITH PLANTING PROCEDURE AND UNDER THE SUPERVISION OF A QUALIFIED PLANTING FOREMAN. PROPER "JETTING IN" SHALL BE ASSURED TO ELIMINATE AIR POCKETS AROUND THE ROOTS. "JET STICK" OR EQUAL IS RECOMMENDED.

8. TAKE ALL NECESSARY PRECAUTIONS TO AVOID DAMAGE TO BUILDINGS AND BUILDING STRUCTURES WHILE INSTALLING TREES.

9. SOIL MIXTURE SHALL BE AS SPECIFIED IN SECTION H OF THESE SPECIFICATIONS. IN ADDITION, EACH PLANTING PIT SHALL RECEIVE 21-GRAM "AGRIFORM" PLANTING TABLETS PER MANUFACTURER'S SPECIFICATIONS OR AS FOLLOWS:

- TWO (2) TABLETS PER 1 GAL. PLANT
- THREE (3) TABLETS PER 3 GAL. PLANT
- FOUR (4) TABLETS PER 10 GAL. PLANT
- LARGER MATERIAL - TWO (2) TABLETS PER 1/2" OF TRUNK CALIPER

10. TREES AND SHRUBS SHALL BE SET STRAIGHT AND AT SUCH A LEVEL THAT AFTER SETTLEMENT, THE PLANT CROWN WILL STAND ONE (1) TO TWO (2) INCHES ABOVE GRADE. EACH PLANT SHALL BE SET IN THE CENTER OF THE PIT. PLANTING SOIL MIXTURE SHALL BE BACKFILLED AND THOROUGHLY TAMPED AROUND THE BALL AND SHALL BE SETTLED BY WATER AFTER TAMPING.

11. FILL HOLE WITH SOIL MIXTURE, MAKING CERTAIN ALL SOIL IS SATURATED. TO DO THIS, FILL HOLE WITH WATER AND ALLOW TO SOAK MINIMUM TWENTY (20) MINUTES, STIRRING IF NECESSARY TO GET SOIL THOROUGHLY WET. PACK LIGHTLY WITH FEET. ADD MORE WET SOIL MIXTURE. DO NOT COVER TOP OF BALL WITH SOIL MIXTURE, ONLY WITH MULCH. ALL BURLAP, ROPE, WIRES, ETC., SHALL BE REMOVED FROM THE SIDES AND TOPS OF BALLS, BUT NO BURLAP SHALL BE PULLED FROM UNDERNEATH.

12. PRUNING: EACH TREE SHALL BE PRUNED TO PRESERVE THE NATURAL CHARACTER OF THE PLANT AS SHOWN ON THE DRAWINGS. ALL SOFT WOOD OR SUCKER GROWTH AND ALL BROKEN OR BADLY DAMAGED BRANCHES SHALL BE REMOVED WITH A CLEAN CUT.

13. SHRUBS AND GROUND COVER PLANTS SHALL BE EVENLY SPACED IN ACCORDANCE WITH THE DRAWINGS AND AS INDICATED ON THE PLANT LIST. CULTIVATE ALL PLANTING AREAS TO A MINIMUM DEPTH OF 6", REMOVE AND DISPOSE ALL WEEDS. TILL INTO TOP 4" THE PLANTING SOIL MIX AS SPECIFIED IN SECTION E. THOROUGHLY WATER ALL PLANTS AFTER INSTALLATION.

14. TREE GUYING AND BRACING SHALL BE INSTALLED BY THE LANDSCAPE CONTRACTOR IN ACCORDANCE WITH THE PLANS TO INSURE STABILITY AND MAINTAIN TREES IN AN UPRIGHT POSITION. IF THE LANDSCAPE CONTRACTOR AND OWNER DECIDE TO WAIVE THE TREE GUYING AND BRACING, THE OWNER SHALL NOTIFY THE LANDSCAPE ARCHITECT IN WRITING OF THEIR INTENTIONS AND AGREE TO HOLD HARMLESS THE LANDSCAPE ARCHITECT IN THE EVENT ANY TREES FALL DOWN AND DAMAGE PERSON OR PROPERTY.

15. MULCHING: PROVIDE A THREE (3) INCH MINIMUM LAYER OF SPECIFIED MULCH OVER THE ENTIRE AREA OF EACH SHRUB BED, GROUND COVER, VINE BED, AND TREE PIT.

16. HERBICIDE WEED CONTROL: ALL PLANT BEDS SHALL BE KEPT FREE OF NOXIOUS WEEDS UNTIL FINAL ACCEPTANCE OF WORK. IF DIRECTED BY THE OWNER, AN APPROVED CHEMICAL HERBICIDE SHALL BE APPLIED FOR WEED CONTROL BY QUALIFIED PERSONNEL TO ALL PLANTING AREAS IN SPOT APPLICATIONS PER MANUFACTURER'S PRECAUTIONS AND SPECIFICATIONS. PRIOR TO FINAL INSPECTION, TREAT ALL PLANTING BEDS WITH AN APPROVED PRE-EMERGENT HERBICIDE AT AN APPLICATION RATE RECOMMENDED BY THE MANUFACTURER.

S. LAWN SODDING

- 1. THE WORK CONSISTS OF LAWN BED PREPARATION, SOIL PREPARATION, AND SODDING, IN STRICT ACCORDANCE WITH THE SPECIFICATIONS AND THE APPLICABLE DRAWINGS TO PRODUCE A GRASS LAWN ACCEPTABLE TO THE OWNER.
2. SOIL PREPARATION: PREPARE LOOSE BED FOUR (4) INCHES DEEP. APPLY FERTILIZER AT RATE OF TWENTY (20) POUNDS PER ONE THOUSAND (1000) SQUARE FEET. APPLICATION SHALL BE UNIFORM UTILIZING APPROVED MECHANICAL SPREADERS. MIX FERTILIZER THOROUGHLY WITH THE SOIL TO A DEPTH OF THREE (3) INCHES. HAND RAKE UNTIL ALL BUMPS AND DEPRESSIONS ARE REMOVED. WET PREPARED AREA THOROUGHLY.
3. LAWN BED PREPARATION: ALL AREAS THAT ARE TO BE SODDED SHALL BE CLEARED OF ANY ROUGH GRASS, WEEDS, AND DEBRIS, AND THE GROUND BROUGHT TO AN EVEN GRADE. THE WHOLE SURFACE SHALL BE ROLLED WITH A ROLLER WEIGHING NOT MORE THAN ONE-HUNDRED (100) POUNDS PER SQUARE FOOT. DURING THE ROLLING, ALL DEPRESSIONS CAUSED BY SETTLEMENT OF ROLLING SHALL BE FILLED WITH ADDITIONAL SOIL, AND THE SURFACE SHALL BE REGRADED AND ROLLED UNTIL PRESENTING A SMOOTH AND EVEN FINISH THAT IS UP TO THE REQUIRED GRADE.
4. SODDING

A. THE CONTRACTOR SHALL SOD ALL AREAS THAT ARE NOT PAVED OR PLANTED AS DESIGNATED ON THE DRAWINGS WITHIN THE CONTRACT LIMITS, UNLESS SPECIFICALLY NOTED OTHERWISE.

B. THE SOD SHALL BE CERTIFIED TO MEET THE STATE PLANT BOARD SPECIFICATIONS, ABSOLUTELY TRUE TO VARIETAL TYPE, AND FREE FROM WEEDS, FUNGUS, INSECTS AND DISEASE OF ANY KIND.

C. SOD PANELS SHALL BE LAID TIGHTLY TOGETHER SO AS TO MAKE A SOLID SODDED LAWN AREA. SOD SHALL BE LAID UNIFORMLY AGAINST THE EDGES OF ALL CURBS AND OTHER HARDSCAPE ELEMENTS, PAVED AND PLANTED AREAS. IMMEDIATELY FOLLOWING SOD LAYING, THE LAWN AREAS SHALL BE ROLLED WITH A LAWN ROLLER CUSTOMARILY USED FOR SUCH PURPOSES, AND THEN THOROUGHLY IRRIGATED. IF, IN THE OPINION OF THE OWNER, TOP-DRESSING IS NECESSARY AFTER ROLLING TO FILL THE VOIDS BETWEEN THE SOD PANELS AND TO EVEN OUT INCONSISTENCIES IN THE SOD, CLEAN SAND AS APPROVED BY THE LANDSCAPE ARCHITECT OR OWNER SHALL BE UNIFORMLY SPREAD OVER THE ENTIRE SURFACE OF THE SOD AND THOROUGHLY WATERED IN.

D. DURING DELIVERY, PRIOR TO AND DURING THE PLANTING OF THE LAWN AREAS, THE SOD PANELS SHALL AT ALL TIMES BE PROTECTED FROM EXCESSIVE DRYING AND UNNECESSARY EXPOSURE OF THE ROOTS TO THE SUN. ALL SOD SHALL BE STACKED SO AS NOT TO BE DAMAGED BY SWEATING OR EXCESSIVE HEAT AND MOISTURE.

5. SEEDING

- A. PROVIDE FRESH, CLEAN, NEW CROP LAWN SEED MIXTURE. FURNISH TO OWNER DEALERS GUARANTEED STATEMENT OF COMPOSITION OF MIXTURE AND PERCENTAGE OF PURITY AND GERMINATION OF EACH VARIETY.
B. SEED MIXTURE: PROVIDE SEED OF GRASS SPECIES AND VARIETIES, PROPORTIONS BY WEIGHT AND MINIMUM PERCENTAGES OF PURITY, GERMINATION, AND MAXIMUM PERCENTAGE OF WEED SEED. SEED MIXTURES VARY BY REGION AND SEASON AND SHALL COMPLY WITH STATE AND LOCAL SOIL CONSERVATION SERVICE STANDARDS FOR LAWN TURF.
C. DO NOT PERFORM SEEDING IN WINDY CONDITIONS.
D. SEEDING SHALL BE DISPERSED IN 2 DIRECTIONS AT RIGHT ANGLES TO EACH OTHER.

E. PERMANENTLY SEED AND MULCH CUT AND FILL SLOPES AS CONSTRUCTION PROCEEDS TO EXTENT CONSIDERED DESIRABLE AND PRACTICAL. IN THE EVENT IT IS NOT PRACTICAL TO SEED AREAS, SLOPES SHALL BE STABILIZED WITH STRAW MULCH AND TACKIFIER, BONDED FIBER MATRIX, NETTING, BLANKETS OR OTHER MEANS TO REDUCE THE EROSION POTENTIAL OF THE AREA.

F. SEED LAWN AREAS BY SOWING EVENLY WITH APPROVED MECHANICAL SEEDER AT RATE OF MINIMUM OF 6 POUNDS PER 1,000 SQUARE FEET. AMOUNT WILL VARY BASED ON VARIETY AND/OR SPECIES. CULTI-PACKER OR APPROVED SIMILAR EQUIPMENT MAY BE USED TO COVER SEED AND TO FORM SEEDBED IN ONE OPERATION. IN AREAS INACCESSIBLE TO CULTI-PACKER, LIGHTLY RAKE SEEDED GROUND WITH FLEXIBLE RAKES AD ROLL WITH WATER BALLAST ROLLER, AFTER ROLLING, MULCH WITH STRAW MULCH AT THE RATE OF 2 TONS PER ACRE.

G. SURFACE LAYER OF SOIL FOR SEEDED AREAS SHALL BE KEPT MOIST DURING THE GERMINATION PERIOD. WATER SEEDED AREAS TWICE DURING THE FIRST WEEK TO A MINIMUM DEPTH OF 6 INCHES WITH A FINE SPRAY; AND, ONCE PER WEEK THEREAFTER AS NECESSARY TO SUPPLEMENT NATURAL RAIN TO EQUIVALENT OF 6 INCHES DEPTH.

H. CONTRACTOR TO REAPPLY SEED AS NECESSARY IN ORDER TO GET ALL SEEDED AREAS ESTABLISHED AS INTENDED.

6. LAWN MAINTENANCE:

- A. WITHIN THE CONTRACT LIMITS, THE CONTRACTOR SHALL PRODUCE A DENSE, WELL ESTABLISHED LAWN. THE CONTRACTOR SHALL BE RESPONSIBLE FOR THE REPAIR AND RE-SODDING OF ALL ERODED, SUNKEN OR BARE SPOTS UNTIL CERTIFICATION OF ACCEPTABILITY BY THE LANDSCAPE ARCHITECT OR OWNER. REPAIRED SODDING SHALL BE ACCOMPLISHED AS IN THE ORIGINAL WORK (INCLUDING REGRADEING IF NECESSARY).
B. WATER EVERY DAY FOR TEN (10) SUCCESSIVE DAYS, THEN WATER THREE (3) TIMES PER WEEK (AT EVEN INTERVALS) FOR TWO (2) ADDITIONAL WEEKS. ALL WATERING SHALL BE OF SUFFICIENT QUANTITY TO WET OR RESTORE WATER TO DEPTH OF FOUR (4) INCHES. CONTRACTOR TO DETERMINE IF SITE IS IN A DROUGHT RESTRICTION AREA AND MUST FOLLOW CITY/ COUNTY PROTOCOL IF ANY ARE IN PLACE.

T. CLEAN-UP

UPON COMPLETION OF ALL PLANTING WORK AND BEFORE FINAL ACCEPTANCE, THE CONTRACTOR SHALL REMOVE ALL MATERIAL, EQUIPMENT, AND DEBRIS RESULTING FROM THEIR WORK. ALL PAVED AREAS SHALL BE BROOM CLEANED AND THE SITE LEFT IN A NEAT AND ACCEPTABLE CONDITION AS APPROVED BY THE OWNER'S AUTHORIZED REPRESENTATIVE.

U. PLANT MATERIAL MAINTENANCE

ALL PLANTS AND PLANTING INCLUDED UNDER THIS CONTRACT SHALL BE MAINTAINED BY WATERING, CULTIVATING, SPRAYING, AND ALL OTHER OPERATIONS NECESSARY TO INSURE A HEALTHY CONDITION BY THE CONTRACTOR UNTIL CERTIFICATION OF ACCEPTABILITY BY THE LANDSCAPE ARCHITECT OR OWNER. MAINTENANCE AFTER THE CERTIFICATION OF ACCEPTABILITY SHALL BE IN ACCORDANCE WITH THE SPECIFICATIONS IN THIS SECTION.

V. MAINTENANCE (ALTERNATE BID ITEM)

1. CONTRACTORS ARE REQUESTED TO PROVIDE A BID ESTIMATE FOR MAINTENANCE FOLLOWING THE INITIAL NINETY (90)-DAY MAINTENANCE PERIOD ON A COST PER MONTH BASIS.

W. GUARANTEE

- 1. THE LIFE AND SATISFACTORY CONDITION OF ALL PLANT MATERIAL INSTALLED BY THE LANDSCAPE CONTRACTOR SHALL BE GUARANTEED BY THE CONTRACTOR FOR A MINIMUM OF ONE (1) CALENDAR YEAR COMMENCING AT THE TIME OF CERTIFICATION OF ACCEPTABILITY BY THE LANDSCAPE ARCHITECT OR OWNER.
2. THE LIFE AND SATISFACTORY CONDITION OF ALL OTHER PLANT MATERIAL (INCLUDING SOD) INSTALLED BY THE LANDSCAPE CONTRACTOR SHALL BE GUARANTEED BY THE CONTRACTOR FOR A MINIMUM OF NINETY (90) CALENDAR DAYS, COMMENCING AT THE TIME OF CERTIFICATION OF ACCEPTABILITY BY THE LANDSCAPE ARCHITECT OR OWNER.
3. REPLACEMENT: ANY PLANT NOT FOUND IN A HEALTHY GROWING CONDITION AT THE END OF THE GUARANTEE PERIOD SHALL BE REMOVED FROM THE SITE AND REPLACED AS SOON AS WEATHER CONDITIONS PERMIT. ALL REPLACEMENTS SHALL BE PLANTS OF THE SAME KIND AND SIZE AS SPECIFIED IN THE PLANT LIST. THEY SHALL BE FURNISHED, PLANTED, AND MULCHED AS SPECIFIED UNDER "PLANTING", AT NO ADDITIONAL COST TO THE OWNER.
4. IN THE EVENT THE OWNER DOES NOT ENGAGE THE CONTRACTOR FOR LANDSCAPE (AND IRRIGATION) MAINTENANCE, THE CONTRACTOR IS ENCOURAGED TO VISIT THE PROJECT SITE PERIODICALLY DURING THE ONE YEAR WARRANTY PERIOD TO EVALUATE MAINTENANCE PROCEDURES BEING PERFORMED BY THE OWNER. CONTRACTOR SHALL NOTIFY THE OWNER IN WRITING OF MAINTENANCE PROCEDURES OR CONDITIONS WHICH THREATEN VIGOROUS AND HEALTHY PLANT GROWTH. IT IS SUGGESTED SUCH SITE VISITS SHALL BE CONDUCTED A MINIMUM OF ONCE PER MONTH FOR A PERIOD OF TWELVE (12) MONTHS FROM THE DATE OF ACCEPTANCE.

X. FINAL INSPECTION AND ACCEPTANCE OF WORK

FINAL INSPECTION AT THE END OF THE GUARANTEE PERIOD SHALL BE ON PLANTING, CONSTRUCTION AND ALL OTHER INCIDENTAL WORK PERTAINING TO THIS CONTRACT. ANY REPLACEMENT AT THIS TIME SHALL BE SUBJECT TO THE SAME ONE (1) YEAR GUARANTEE (OR AS SPECIFIED BY THE LANDSCAPE ARCHITECT OR OWNER IN WRITING) BEGINNING WITH THE TIME OF REPLACEMENT AND ENDING WITH THE SAME INSPECTION AND ACCEPTANCE HEREIN DESCRIBED.



BGE, Inc.
2595 Dallas Parkway, Suite 101
Frisco, TX 75034
Tel: 972-464-4800 • www.bgeinc.com
TBPE Registration No. F-1046
Copyright 2023

OWNER/DEVELOPER



646 S. FLORES ST.
SAN ANTONIO, TX 78204
TEL: (210) 938-4076
CONTACT: LANCE KLEIN

LANDSCAPE ARCHITECT

BGE, INC.
2595 DALLAS PKWY.,
SUITE 101
FRISCO, TX 75034
CONTACT: MICHAEL
STOTTLER, PLA
PHONE: (972) 372-9381

LANDSCAPE SPECIFICATIONS

H-E-B ROCKWALL

LOT 1, BLOCK 1

CITY OF ROCKWALL, ROCKWALL COUNTY, TEXAS

THESE PLANS ARE ISSUED FOR THE PURPOSE OF PRELIMINARY REVIEW AND ARE NOT INTENDED FOR CONSTRUCTION. WHEN ISSUED IN FINAL FORM THEY WILL BE SEALED, SIGNED AND DATED.

RESPONSIBLE LANDSCAPE ARCHITECT: MICHAEL STOTTLER, PLA, TEXAS REGISTRATION NO. 3743 BGE, INC. TEXAS REGISTERED ENGINEERING FIRM F-1046

December 15, 2023

CAUTION !!

Contractor to Verify exact location & Depth of Exist Facilities Prior to any Construction Activities

CAUTION !!!

CONTACT: 1-800-DIG-TESS 48 HOURS PRIOR TO CONSTRUCTION

Table with 3 columns: REVISIONS, REV. NO., DATE, DESCRIPTION. Includes a header row and several empty rows for revisions.

CHECKED BY: MLS
DESIGNED BY: ACS
DATE: December 13, 2023
PROJECT NUMBER: 9559-01

SHEET NO

L0.02

LANDSCAPE SPECIFICATIONS

BGE, INC. © 2023. All rights reserved. THE DOCUMENT, TOGETHER WITH THE CONCEPTS AND DESIGN PRESENTED HEREIN, AS AN INSTRUMENT OF SERVICE, IS INTENDED ONLY FOR THE SPECIFIC PURPOSE AND CLIENT FOR WHICH IT WAS PREPARED. REUSE OF AND IMPROPER RELIANCE ON THIS DOCUMENT WITHOUT WRITTEN AUTHORIZATION AND ADAPTATION BY BGE, INC. SHALL BE WITHOUT LIABILITY TO BGE, INC.

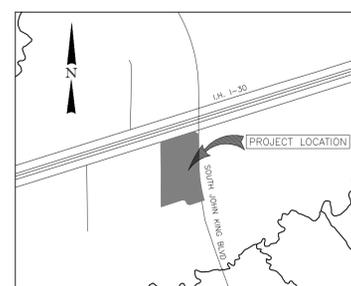
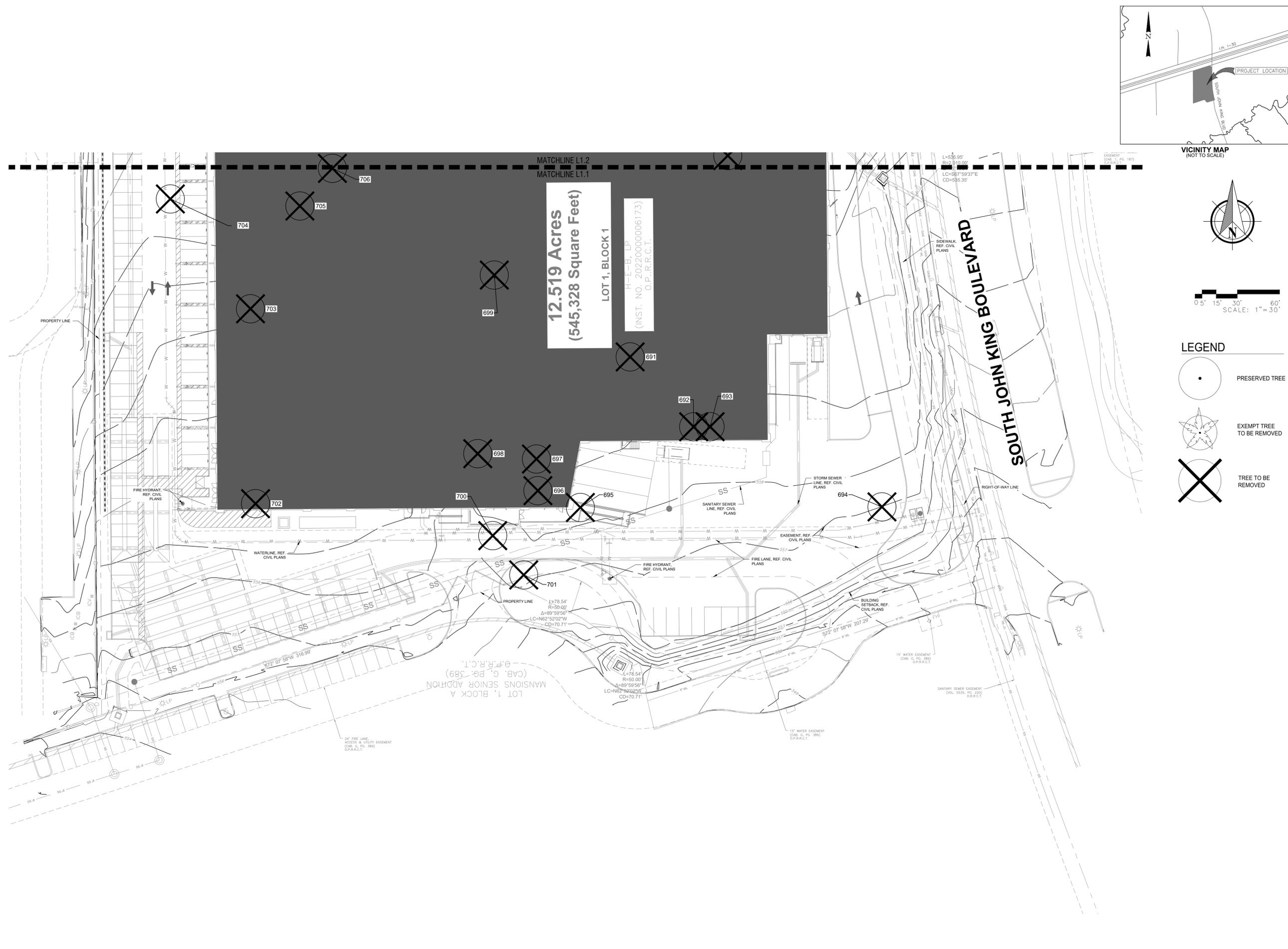

LEGEND

-  PRESERVED TREE
-  EXEMPT TREE TO BE REMOVED
-  TREE TO BE REMOVED

12.519 Acres
(545,328 Square Feet)
 LOT 1, BLOCK 1
 H-E-B, LP
 (INST. NO. 20220000006173)
 O.P., R.R.C.T.

SOUTH JOHN KING BOULEVARD

BGE, Inc.
 2595 Dallas Parkway, Suite 101
 Frisco, TX 75034
 Tel: 972-464-4800 • www.bgeinc.com
 TBPE Registration No. F-1046
 Copyright 2023

OWNER/DEVELOPER

 646 S. FLORES ST.
 SAN ANTONIO, TX 78204
 TEL: (210) 938-4076
 CONTACT: LANCE KLEIN

LANDSCAPE ARCHITECT
BGE, INC.
 2595 DALLAS PKWY.,
 SUITE 101
 FRISCO, TX 75034
 CONTACT: MICHAEL
 STOTTLER, PLA
 PHONE: (972) 372-9381

TREE PRESERVATION PLAN

H-E-B ROCKWALL

LOT 1, BLOCK 1
 CITY OF ROCKWALL, ROCKWALL COUNTY, TEXAS

THESE PLANS ARE ISSUED FOR THE PURPOSE OF PRELIMINARY REVIEW AND ARE NOT INTENDED FOR CONSTRUCTION. WHEN ISSUED IN FINAL FORM THEY WILL BE SEALED, SIGNED AND DATED.
 RESPONSIBLE LANDSCAPE ARCHITECT:
 MICHAEL STOTTLER, PLA
 TEXAS REGISTRATION NO. 3743
 BGE, INC.
 TEXAS REGISTERED ENGINEERING FIRM F-1046
 December 15, 2023

!CAUTION!
 Contractor to Verify exact location & Depth of Exist Facilities Prior to any Construction Activities

CAUTION!!!
 CONTACT: 1-800-DIG-TESS
 48 HOURS PRIOR TO CONSTRUCTION

REVISIONS		
REV. NO.	DATE	DESCRIPTION

CHECKED BY: MLS
 DESIGNED BY: ACS
 DATE: December 13, 2023
 PROJECT NUMBER: 9559-01

SHEET NO
L1.01
 TREE PRESERVATION PLAN

Luminaire Schedule					
Symbol	Qty	Label	Description	Luminaire Watts	BUG Rating
☐→	2	M2-18	MRM-LED-18L-SIL-2-50-70CRI-IL	135	B1-U0-G2
☐→	4	M3-12	MRM-LED-12L-SIL-3-40-70CRI	85	B2-U0-G2
☐→	17	M4-12	MRM-LED-12L-SIL-FT-40-70CRI-IL	85	B1-U0-G2
☐→	10	M4-18	MRM-LED-18L-SIL-FT-40-70CRI-IL	135	B1-U0-G3
☐→	20	M5-36	MRM-LED-30L-SIL-5W-40-70CRI	232	B5-U0-G3
⊕	17	RD	HC615D010-HM612840-61MDH	14	B1-U0-G0
⊕	51	RE	HC640D010-HM634835-61WDH	40	B3-U0-G0
⊥	19	X5	AXCL6A	56.43	B2-U0-G1

Calculation Summary							
Label	CalcType	Units	Avg	Max	Min	Avg/Min	Max/Min
Parking Lot	Illuminance	Fc	3.17	23.3	0.0	N.A.	N.A.
Property Line	Illuminance	Fc	0.12	0.2	0.0	N.A.	N.A.
Curbside	Illuminance	Fc	10.90	23.3	0.6	18.17	38.83
Front of Store Drive	Illuminance	Fc	2.70	5.3	0.1	27.00	53.00
Main Parking	Illuminance	Fc	2.71	5.7	1.5	1.81	3.80
Rear Entry Drive	Illuminance	Fc	2.30	3.9	0.1	23.00	39.00
Side Parking	Illuminance	Fc	2.44	3.6	0.7	3.49	5.14
TXBBO	Illuminance	Fc	4.36	12.1	1.3	3.35	9.31

Luminaires & Lamps Furnished By Villa Lighting Inc. St Louis, MO. 63103
 (800)325-0693
 www.villalighting.com

The electrical contractor shall be responsible for receiving, storage, installation and wiring of light fixtures.

The electrical contractor shall report any damaged light fixtures or missing parts to Villa Lighting within 48 hours of receipt of light fixture package.

Design is based on current information provided at the time of request. Any changes in mounting height, mounting location, lamp wattage, lamp type, and existing field conditions that effect any of the previously mentioned will void the current layout and require a change request and recalculation. Calculations are based upon a computer simulation and actual field calculations may vary.

Fixtures mounted on 35' pole & 3' base
 Light level calculated on the ground

#	Date	Comments

#	Date	Revisions

--	--	--	--	--	--

Date: 12/1/2023

HEB
 ROCKWALL, TX



Mirada Medium (MRM)

Outdoor LED Area Light



IP66 IK08



OVERVIEW

Lumen Package	7,000 - 48,000
Wattage Range	48 - 401
Efficacy Range (LPW)	117 - 160
Weight lbs(kg)	30 (13.6)

QUICK LINKS

[Ordering Guide](#)[Performance](#)[Photometrics](#)[Dimensions](#)

FEATURES & SPECIFICATIONS

Construction

- Rugged die-cast aluminum housing contains factory prewired driver and optical unit. Cast aluminum wiring access door located underneath.
- Designed to mount to square or round poles.
- Fixtures are finished with LSI's DuraGrip® polyester powder coat finishing process. The DuraGrip finish withstands extreme weather changes without cracking or peeling. Other standard LSI finishes available. Consult factory.
- Shipping weight: 37 lbs in carton.

Optical System

- State-of-the-Art one piece silicone optic sheet delivers industry leading optical control with an integrated gasket to provide IP66 rated sealed optical chamber in 1 component.
- Proprietary silicone refractor optics provide exceptional coverage and uniformity in IES Types 2, 3, 5W, FT, FTA and AM.
- Silicone optical material does not yellow or crack with age and provides a typical light transmittance of 93%.
- Zero uplight.
- Available in 5000K, 4000K, and 3000K color temperatures per ANSI C78.377. Also Available in Phosphor Converted Amber with Peak intensity at 610nm.
- Minimum CRI of 70.
- Integral louver (IL) and integral half louver (IH) options available for enhanced backlight control.

Electrical

- High-performance programmable driver features over-voltage, under-voltage, short-circuit and over temperature protection. Custom lumen and wattage packages available.
 - 0-10V dimming (10% - 100%) standard.
 - Standard Universal Voltage (120-277 Vac) Input 50/60 Hz or optional High Voltage (347-480 Vac).
 - L80 Calculated Life: >100k Hours (See Lumen Maintenance chart)
 - Total harmonic distortion: <20%
 - Operating temperature: -40°C to +50°C (-40°F to +122°F). 42L and 48L lumen packages rated to +40°C.
 - Power factor: >.90
 - Input power stays constant over life.
 - Field replaceable 10kV surge protection device meets a minimum Category C Low operation (per ANSI/IEEE C62.41.2).
 - High-efficacy LEDs mounted to metal-core circuit board to maximize heat dissipation
 - Components are fully encased in potting material for moisture resistance. Driver complies with FCC standards. Driver and key electronic components can easily be accessed.
- ### Controls
- Optional integral passive infrared Bluetooth™ motion and photocell sensor (see page 8 for more details). Fixtures operate independently and can be commissioned via iOS or Android configuration app
 - LSI's AirLink™ wireless control system options reduce energy and maintenance

costs while optimizing light quality 24/7. (see controls section for more details).

Installation

- Designed to mount to square or round poles.
- A single fastener secures the hinged door, underneath the housing and provides quick & easy access to the electrical compartment.
- Included terminal block accepts up to 12 ga. wire.
- Utilizes LSI's traditional 3" drill pattern B3 for easy fastening of LSI products.

Warranty

- LSI LED Fixtures carry a 5-year warranty.

Listings

- Listed to UL 1598 and UL 8750.
- Meets Buy American Act requirements.
- IDA compliant; with 3000K color temperature selection.
- Title 24 Compliant; see local ordinance for qualification information.
- Suitable for wet Locations.
- IP66 rated Luminaire per IEC 60598.
- 3G rated for ANSI C136.31 high vibration applications are qualified.
- DesignLights Consortium® (DLC) qualified product. Not all versions of this product may be DLC qualified. Please check the DLC Qualified Products List at www.designlights.org/QPL to confirm which versions are qualified.
- Patented Silicone Optics (US Patent NO. 10,816,165 B2)
- IK08 rated luminaire per IEC 66262 mechanical impact code



Mirada Medium Outdoor LED Area Light

Type : _____

 **Have questions?** Call us at (800) 436-7800

ORDERING GUIDE

[Back to Quick Links](#)

TYPICAL ORDER EXAMPLE: MRM LED 36L SIL FTA UNV DIM 50 70CRI ALS04 BRZ IL

Prefix	Light Source	Lumen Package	Lens	Distribution	Orientation ²	Voltage	Driver
MRM - Mirada Medium Area Light	LED	7L - 7,000 lms 9L - 9,000 lms 12L - 12,000 lms 18L - 18,000 lms 24L - 24,000 lms 30L - 30,000 lms 36L - 36,000 lms 42L - 42,000 lms 48L - 48,000 lms Custom Lumen Packages ¹	SIL - Silicone	2 - Type 2 3 - Type 3 5W - Type 5 Wide FT - Forward Throw FTA - Forward Throw Automotive AM - Automotive Merchandise	(blank) - standard L - Optics rotated left 90° R - Optics rotated right 90°	UNV - Universal Voltage (120-277V) HV - High Voltage (347-480V)	DIM - 0-10V Dimming (0-10%)
Color Temp		Color Rendering	Finish		Options		
50 - 5,000 CCT 40 - 4,000 CCT 30 - 3,000 CCT AMB - Phosphor Converted Amber ¹²		70CRI - 70 CRI	BLK - Black BRZ - Dark Bronze GMG - Gun Metal Gray GPT - Graphite		MSV - Metallic Silver PLP - Platinum Plus SVG - Satin Verde Green WHT - White		(Blank) - None IH - Integral Half Louver (Moderate Spill Light Cutoff) ² IL - Integral Louver (Sharp Spill Light Cutoff) ²

Controls (Choose One)

(Blank) - None

Wireless Controls System

- ALSC** - AirLink Synapse Control System
- ALSCH** - AirLink Synapse Control System Host / Satellite³
- ALSCS02** - AirLink Synapse Control System with 12-20' Motion Sensor
- ALSCS04** - AirLink Synapse Control System with 20-40' Motion Sensor³
- ALSCHS04** - AirLink Synapse Control System Host / Satellite with 20-40' Motion Sensor³
- ALBCS1** - AirLink Blue Wireless Motion & Photo Sensor Controller (8-24' mounting height)
- ALBCS2** - AirLink Blue Wireless Motion & Photo Sensor Controller (25-40' mounting height)

Stand-Alone Controls

- EXT** - 0-10V Dimming leads extended to housing exterior
- CR7P** - 7 Pin Control Receptacle ANSI C136.41⁶
- IMSBT1** - Integral Bluetooth™ Motion and Photocell Sensor (8-24' MH)⁵
- IMSBT2** - Integral Bluetooth™ Motion and Photocell Sensor (25-40' MH)⁵

Button Type Photocells

- PC120** - 120V
- PC208-277** - 208-277V
- PC347** - 347V



Need more information?
Click here for our glossary

Have additional questions?
Call us at (800) 436-7800



ACCESSORY ORDERING INFORMATION⁷

CONTROLS ACCESSORIES	
Description	Order Number
PC120 Photocell for use with CR7P option (120V) ⁸	122514
PC208-277 Photocell for use with CR7P option (208V, 240V, 277V) ⁸	122515
Twist Lock Photocell (347V) for use with CR7P ⁸	122516
Twist Lock Photocell (480V) for use with CR7P ⁸	1225180
AirLink 5 Pin Twist Lock Controller ⁸	661409
AirLink 7 Pin Twist Lock Controller ⁸	661410
Shorting Cap for use with CR7P	149328

FUSING OPTIONS ¹¹	
Single Fusing (120V)	See Fusing Accessory Guide
Single Fusing (277V)	
Double Fusing (208V, 240V)	
Double Fusing (480V)	
Double Fusing (347V)	

SHIELDING OPTIONS	
Mirada Small	See Shielding Guide
Mirada Medium	
Mirada Large	
Zone Medium	
Zone Large	
Slice Medium	

1. Custom lumen and wattage packages available, consult factory. Values are within industry standard tolerances but not DLC listed.
 2. Not available with 5W distribution
 3. Consult Factory for availability.
 4. Not available in HV.
 5. IMSBT is field configurable via the LSI app that can be downloaded from your smartphone's native app store.
 6. Control device or shorting cap must be ordered separately. See Accessory Ordering Information.

7. Accessories are shipped separately and field installed.
 8. Factory installed CR7P option required. See Options.
 9. "CLR" denotes finish. See Finish options.
 10. Only available with ALSC/ALSCH control options.
 11. Fusing must be located in hand hole of pole. See [Fusing Accessory Guide](#) for compatibility.
 12. Only available in 9L, 12L, 18L and 24L Lumen Packages. Consult factory for lead time and availability.

Mirada Medium Outdoor LED Area Light

Type : _____

Have questions? Call us at (800) 436-7800

ACCESSORIES

MOUNTING ACCESSORIES	
Side Arm	Universal Mounting Bracket Mounts to $\geq 3"$ square or round (tapered/straight) poles with (2) mounting hole spaces between 3.5" to 5" Part Number: BKA UMB CLR
	Quick Mount Plate True one person installation to existing/new construction poles with hole spaces between 2.4 to 4.6" Part Number: BKS PQM B3B5 XX CLR
	15° Tilt Quick Mount Plate True one person installation to existing/new construction poles with hole spaces between 2.4 to 4.6" Part Number: BKS PQ15 B3B5 XX CLR
Tenon / Slipfitter	Adjustable Slipfitter Mounts onto a 2" (51mm) IP, 2.375" (60mm) O.D. tenon and provides 180° of tilt (max 45° above horizontal) Part Number: BKA ASF CLR
	Square Tenon Top Mounts onto a 2" (51mm) IP, 2.375" (60mm) O.D. tenon and allows for mounting up to 4 luminaires Part Number: BKA XNM *
	Square Internal Slipfitter Mounts inside 4" or 5" square pole and allows for mounting up to 4 luminaires Part Number: BKA X_ISF * CLR
Wall Mount/ Wood Pole	Wall Mount Bracket Mounts onto vertical wall surface (hardware/anchors not included) Part Number: BKS XBO WM CLR
	Wood Pole Bracket Mounts onto wooden poles (6" minimum OD, hardware/anchors not included) Part Number: BKS XBO WP CLR

SHIELDING, POLES & MISC. ACCESSORIES	
Shielding	Integral Louver Field Install Integral Louver provides maximum backlight control by shielding each individual row of LEDs Part Number: 686485
	Integral Half Louver Field Install Integral Half Louver provides great backlight control without impacting front side distribution. Part Number: 743416
	External Shield External shield blocks view of light source from anyside of luminaire, additional shielding configurations available Part Number: 785970BLK (3") / 785962BLK (6")
Poles	Square Poles 14 - 39" steel and aluminum poles in 4", 5" and 6" sizes for retrofit and new construction Part Number: 45Q/55Q/65Q
	Round Poles 10 - 30" steel and aluminum poles in 4" and 5" sizes for retrofit and new construction Part Number: 4RP/5RP
	Tapered Poles 20" - 39" steel and aluminum poles for retrofit and new construction Part Number: RTP
Misc.	Bird Spikes 10' Linear Bird Spike Kit, 4' recommended per luminaire, includes silicone adhesive and application tool Part Number: 736795

Replace CLR with paint finish description
 Replace XX with SQ for square pole or RD for round pole ($\geq 3"$ OD)
 Replace * with S (Single), D180 (Double @180°), D90 (Double @90°), T90 (Triple), Q90 (Quad)
 Replace _ with 4 (4" square pole) or 5 (5" square pole)

OPTICS ROTATION

Top View

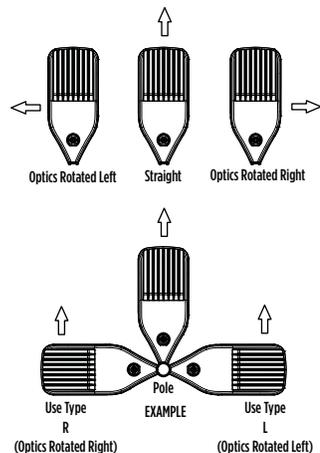

ACCESSORIES/OPTIONS

Integral Louver (IL) and House-Side Shield (IH)

Integral louver (IL) and half louver (IH) accessory shields available for improved backlight control without sacrificing street side performance. LSI's Integral Louver (IL) and Integral House-Side Shield (IH) options deliver backlight control that significantly reduces spill light behind the poles for applications with pole locations close to adjacent properties. The design maximizes forward reflected light while reducing glare, maintaining the optical distribution selected, and most importantly eliminating light trespass. Both options rotate

Luminaire Shown with Integral Louver (IL)



Luminaire Shown with IMSBT Option



7 Pin Photoelectric Control

7-pin ANSI C136.41-2013 control receptacle option available for twist lock photocontrols or wireless control modules. Control accessories sold separately. Dimming leads from the receptacle will be connected to the driver dimming leads (Consult factory for alternate wiring).

Luminaire Shown with CR7P



Mirada Medium Outdoor LED Area Light

Type : _____

 Have questions? Call us at (800) 436-7800

PERFORMANCE

[Back to Quick Links](#)

DELIVERED LUMENS*												
Lumen Package	Distribution	CRI	3000K CCT			4000K CCT			5000K CCT			Wattage
			Delivered Lumens	Efficacy	BUG Rating	Delivered Lumens	Efficacy	BUG Rating	Delivered Lumens	Efficacy	BUG Rating	
7L	2	70	7560	157	B2-U0-G2	7560	157	B2-U0-G2	7560	157	B2-U0-G2	48
	3		7616	159	B1-U0-G2	7616	159	B1-U0-G2	7616	159	B1-U0-G2	
	5W		7292	152	B3-U0-G1	7292	152	B3-U0-G1	7292	152	B3-U0-G1	
	FT		7562	158	B2-U0-G2	7562	158	B2-U0-G2	7562	158	B2-U0-G2	
	FTA		7595	158	B2-U0-G2	7595	158	B2-U0-G2	7595	158	B2-U0-G2	
	AM		7687	160	B1-U0-G1	7687	160	B1-U0-G1	7687	160	B1-U0-G1	
9L	2	70	9853	159	B2-U0-G2	9853	159	B2-U0-G2	9853	159	B2-U0-G2	62
	3		9926	160	B2-U0-G2	9926	160	B2-U0-G2	9926	160	B2-U0-G2	
	5W		9504	153	B3-U0-G2	9504	153	B3-U0-G2	9504	153	B3-U0-G2	
	FT		9856	159	B2-U0-G3	9856	159	B2-U0-G3	9856	159	B2-U0-G3	
	FTA		9900	160	B2-U0-G2	9900	160	B2-U0-G2	9900	160	B2-U0-G2	
	AM		10019	162	B2-U0-G1	10019	162	B2-U0-G1	10019	162	B2-U0-G1	
12L	2	70	13135	155	B3-U0-G2	13135	155	B3-U0-G2	13135	155	B3-U0-G2	85
	3		13232	156	B2-U0-G2	13232	156	B2-U0-G2	13232	156	B2-U0-G2	
	5W		12669	149	B4-U0-G2	12669	149	B4-U0-G2	12669	149	B4-U0-G2	
	FT		13138	155	B2-U0-G3	13138	155	B2-U0-G3	13138	155	B2-U0-G3	
	FTA		13196	155	B2-U0-G2	13196	155	B2-U0-G2	13196	155	B2-U0-G2	
	AM		13355	157	B2-U0-G2	13355	157	B2-U0-G2	13355	157	B2-U0-G2	
18L	2	70	19318	143	B3-U0-G3	19318	143	B3-U0-G3	19318	143	B3-U0-G3	135
	3		19461	144	B3-U0-G3	19461	144	B3-U0-G3	19461	144	B3-U0-G3	
	5W		18633	138	B4-U0-G2	18633	138	B4-U0-G2	18633	138	B4-U0-G2	
	FT		19324	143	B3-U0-G3	19324	143	B3-U0-G3	19324	143	B3-U0-G3	
	FTA		19408	144	B3-U0-G3	19408	144	B3-U0-G3	19408	144	B3-U0-G3	
	AM		19641	145	B3-U0-G2	19641	145	B3-U0-G2	19641	145	B3-U0-G2	
24L	2	70	25957	147	B4-U0-G3	25957	147	B4-U0-G3	25957	147	B4-U0-G3	176
	3		26149	149	B3-U0-G4	26149	149	B3-U0-G4	26149	149	B3-U0-G4	
	5W		25037	142	B5-U0-G3	25037	142	B5-U0-G3	25037	142	B5-U0-G3	
	FT		25964	148	B3-U0-G4	25964	148	B3-U0-G4	25964	148	B3-U0-G4	
	FTA		26077	148	B3-U0-G3	26077	148	B3-U0-G3	26077	148	B3-U0-G3	
	AM		26393	150	B3-U0-G2	26393	150	B3-U0-G2	26393	150	B3-U0-G2	
30L	2	70	32417	140	B4-U0-G3	32417	140	B4-U0-G3	32417	140	B4-U0-G3	232
	3		32656	141	B3-U0-G4	32656	141	B3-U0-G4	32656	141	B3-U0-G4	
	5W		31267	135	B5-U0-G3	31267	135	B5-U0-G3	31267	135	B5-U0-G3	
	FT		32424	140	B3-U0-G4	32424	140	B3-U0-G4	32424	140	B3-U0-G4	
	FTA		32566	140	B4-U0-G3	32566	140	B4-U0-G3	32566	140	B4-U0-G3	
	AM		32960	142	B3-U0-G3	32960	142	B3-U0-G3	32960	142	B3-U0-G3	
36L	2	70	38275	133	B4-U0-G4	38275	133	B4-U0-G4	38275	133	B4-U0-G4	288
	3		38557	134	B4-U0-G5	38557	134	B4-U0-G5	38557	134	B4-U0-G5	
	5W		36917	128	B5-U0-G4	36917	128	B5-U0-G4	36917	128	B5-U0-G4	
	FT		38283	133	B4-U0-G5	38283	133	B4-U0-G5	38283	133	B4-U0-G5	
	FTA		38450	134	B4-U0-G4	38450	134	B4-U0-G4	38450	134	B4-U0-G4	
	AM		38916	135	B3-U0-G3	38916	135	B3-U0-G3	38916	135	B3-U0-G3	

Mirada Medium Outdoor LED Area Light

Type : _____

 Have questions? Call us at (800) 436-7800

PERFORMANCE (CONT.)

DELIVERED LUMENS*												
Lumen Package	Distribution	CRI	3000K CCT			4000K CCT			5000K CCT			Wattage
			Delivered Lumens	Efficacy	BUG Rating	Delivered Lumens	Efficacy	BUG Rating	Delivered Lumens	Efficacy	BUG Rating	
42L	2	70	44118	125	B5-U0-G4	44118	125	B5-U0-G4	44118	125	B5-U0-G4	354
	3		44444	126	B4-U0-G5	44444	126	B4-U0-G5	44444	126	B4-U0-G5	
	5W		42555	120	B5-U0-G4	42555	120	B5-U0-G4	42555	120	B5-U0-G4	
	FT		44130	125	B4-U0-G5	44130	125	B4-U0-G5	44130	125	B4-U0-G5	
	FTA		44322	125	B4-U0-G4	44322	125	B4-U0-G4	44322	125	B4-U0-G4	
	AM		44859	127	B4-U0-G3	44859	127	B4-U0-G3	44859	127	B4-U0-G3	
48L	2	70	48795	122	B5-U0-G4	48795	122	B5-U0-G4	48795	122	B5-U0-G4	401
	3		49156	123	B4-U0-G5	49156	123	B4-U0-G5	49156	123	B4-U0-G5	
	5W		47066	117	B5-U0-G4	47066	117	B5-U0-G4	47066	117	B5-U0-G4	
	FT		48809	122	B4-U0-G5	48809	122	B4-U0-G5	48809	122	B4-U0-G5	
	FTA		49021	122	B5-U0-G4	49021	122	B5-U0-G4	49021	122	B5-U0-G4	
	AM		49615	124	B4-U0-G3	49615	124	B4-U0-G3	49615	124	B4-U0-G3	

ELECTRICAL DATA (AMPS)*						
Lumens	120V	208V	240V	277V	347V	480V
7L	0.40	0.23	0.20	0.17	0.14	0.10
9L	0.52	0.30	0.26	0.22	0.18	0.13
12L	0.71	0.41	0.35	0.31	0.24	0.18
18L	1.13	0.65	0.56	0.49	0.39	0.28
24L	1.47	0.85	0.73	0.64	0.51	0.37
30L	1.93	1.12	0.97	0.84	0.67	0.48
36L	2.40	1.38	1.20	1.04	0.83	0.60
42L	2.95	1.70	1.48	1.28	1.02	0.74
48L	3.4A	1.9A	1.7A	1.5A	1.2A	0.8A

ELECTRICAL DATA - PHOSPHOR CONVERTED AMBER (AMPS)*							
Lumens	Watts	120V	208V	240V	277V	347V	480V
9L	74.3	0.6A	0.4A	0.3A	0.3A	0.2A	0.2A
12L	102.9	0.9A	0.5A	0.4A	0.4A	0.3A	0.2A

*Electrical data at 25°C (77°F). Actual wattage may differ by +/-10%

RECOMMENDED LUMEN MAINTENANCE ¹ (7-18L)					
Ambient	Initial ²	25h ²	50hr ²	75hr ²	100hr ²
0-50 C	100%	96%	92%	88%	84%

RECOMMENDED LUMEN MAINTENANCE ¹ (24-48L)					
Ambient	Initial ²	25h ²	50hr ²	75hr ²	100hr ²
0-40 C	100%	100%	97%	94%	92%

1. Lumen maintenance values at 25C are calculated per TM-21 based on LM-80 data and in-situ testing.

2. In accordance with IESNA TM-21-11, Projected Values represent interpolated value based on time durations that are within six times the IESNA LM-80-08 total test duration for the device under testing.

3. In accordance with IESNA TM-21-11, Calculated Values represent time durations that exceed six times the IESNA LM-80-08 total test duration for the device under testing.

DELIVERED LUMENS*					
Lumen Package	Distribution	Phosphor Converted Amber (Peak 610nm)			Wattage
		Delivered Lumens	Efficacy	BUG Rating	
9L	2	5848	80	B2-U0-G2	74
	3	6018	82	B1-U0-G2	
	5W	5471	74	B3-U0-G1	
	FT	5801	79	B1-U0-G2	
	FTA	5924	81	B1-U0-G1	
	AM	5995	81	B1-U0-G1	
12L	2	7550	74	B2-U0-G2	102
	3	7749	76	B1-U0-G2	
	5W	7045	69	B3-U0-G2	
	FT	7470	73	B2-U0-G2	
	FTA	7628	75	B2-U0-G2	
	AM	7720	76	B1-U0-G1	
18L	2	9311	69	B2-U0-G2	135
	3	9582	71	B2-U0-G2	
	5W	8712	65	B3-U0-G2	
	FT	9237	68	B2-U0-G2	
	FTA	9433	70	B2-U0-G2	
	AM	9546	71	B2-U0-G1	
24L	2	10955	63	B2-U0-G2	175
	3	11273	64	B2-U0-G2	
	5W	10249	59	B3-U0-G2	
	FT	10867	62	B2-U0-G2	
	FTA	11097	63	B2-U0-G2	
	AM	11230	64	B2-U0-G1	

*LEDs are frequently updated therefore values are nominal.

Mirada Medium Outdoor LED Area Light

Type : _____

 Have questions? Call us at (800) 436-7800

PHOTOMETRICS

[Back to Quick Links](#)

Luminaire photometry has been conducted by a NVLAP accredited testing laboratory in accordance with IESNA LM-79-08. As specified by IESNA LM-79-08 the entire luminaire is tested as the source resulting in a luminaire efficiency of 100%.

See the individual product page on <https://www.lsicorp.com/> for detailed photometric data.

MRM-LED-30L-SIL-2-40-70CRI

Luminaire Data	
Type 2 Distribution	
Description	4000 Kelvin, 70 CRI
Delivered Lumens	32,416
Watts	232
Efficacy	140
IES Type	Type II - Short
BUG Rating	B4-U0-G3

Zonal Lumen Summary		
Zone	Lumens	% Luminaire
Low (0-30°)	4796	15%
Medium (30-60°)	19811	61%
High (60-80°)	7474	23%
Very High (80-90°)	335	1%
Uplight (90-180°)	0	0%
Total Flux	32416	100%

ISO Footcandle

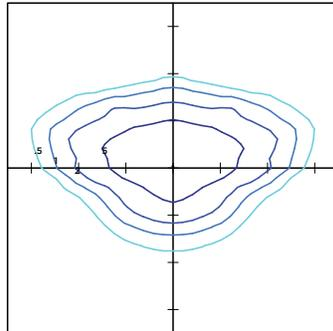

POLAR CURVE

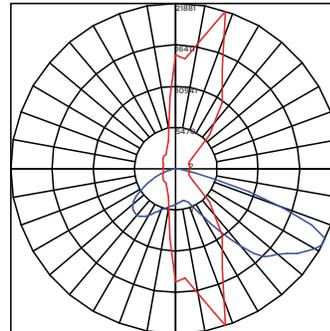

25' Mounting Height/ 25' Grid Spacing

■ 5 FC ■ 2 FC ■ 1 FC ■ 0.5 FC

MRM-LED-30L-SIL-3-40-70CRI

Luminaire Data	
Type 3 Distribution	
Description	4000 Kelvin, 70 CRI
Delivered Lumens	32,656
Watts	232
Efficacy	141
IES Type	Type III - Short
BUG Rating	B3-U0-G4

Zonal Lumen Summary		
Zone	Lumens	% Luminaire
Low (0-30°)	3385	10%
Medium (30-60°)	16250	50%
High (60-80°)	12430	38%
Very High (80-90°)	591	2%
Uplight (90-180°)	0	0%
Total Flux	32656	100%

ISO Footcandle

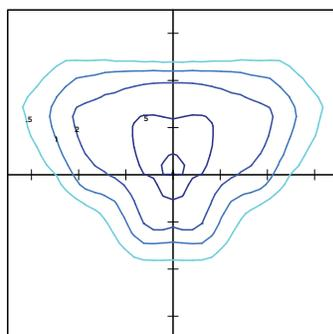

POLAR CURVE

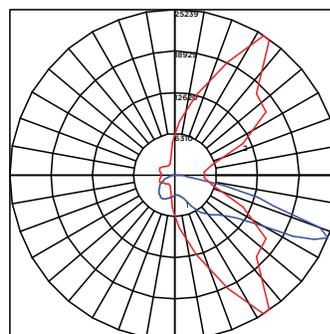

25' Mounting Height/ 25' Grid Spacing

■ 5 FC ■ 2 FC ■ 1 FC ■ 0.5 FC

MRM-LED-30L-SIL-FT-40-70CRI

Luminaire Data	
Type FT Distribution	
Description	4000 Kelvin, 70 CRI
Delivered Lumens	32,424
Watts	232
Efficacy	140
IES Type	Type IV - Short
BUG Rating	B3-U0-G4

Zonal Lumen Summary		
Zone	Lumens	% Luminaire
Low (0-30°)	3952	12%
Medium (30-60°)	15505	48%
High (60-80°)	12279	38%
Very High (80-90°)	688	2%
Uplight (90-180°)	0	0%
Total Flux	32424	100%

ISO Footcandle

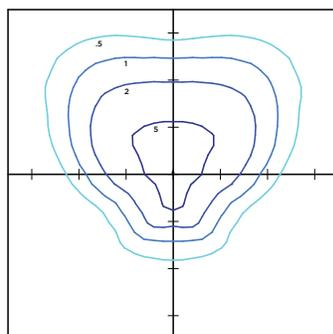

POLAR CURVE

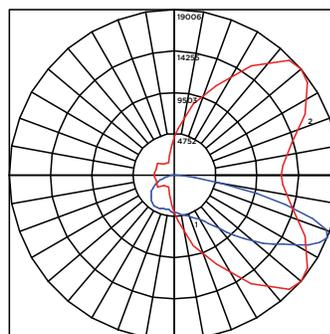

25' Mounting Height/ 25' Grid Spacing

■ 5 FC ■ 2 FC ■ 1 FC ■ 0.5 FC

Mirada Medium Outdoor LED Area Light

Type : _____

 Have questions? Call us at (800) 436-7800

PHOTOMETRICS (CONT)

MRM-LED-30L-SIL-5W-40-70CRI

Luminaire Data	
Type 5W Distribution	
Description	4000 Kelvin, 70 CRI
Delivered Lumens	31,267
Watts	232
Efficacy	135
IES Type	Type VS - Short
BUG Rating	B5-U0-G3

Zonal Lumen Summary		
Zone	Lumens	% Luminaire
Low (0-30°)	3138	10%
Medium (30-60°)	13193	42%
High (60-80°)	14641	47%
Very High (80-90°)	296	1%
Uplight (90-180°)	0	0%
Total Flux	31267	100%

ISO Footcandle

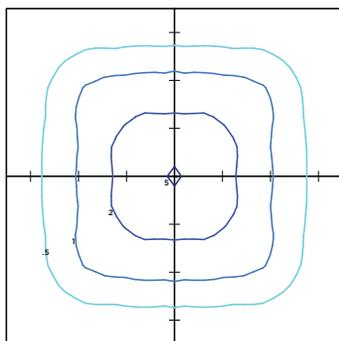

POLAR CURVE

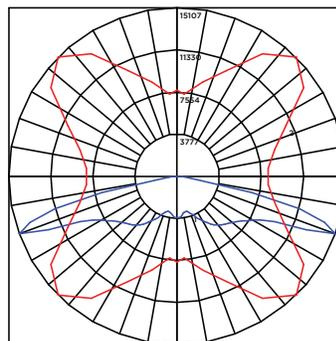

25' Mounting Height/ 25' Grid Spacing

■ 5 FC ■ 2 FC ■ 1 FC ■ 0.5 FC

MRM-LED-30L-SIL-FTA-40-70CRI

Luminaire Data	
Type FTA Distribution	
Description	4000 Kelvin, 70 CRI
Delivered Lumens	32,566
Watts	232
Efficacy	140
IES Type	Type VS - Short
BUG Rating	B4-U0-G3

Zonal Lumen Summary		
Zone	Lumens	% Luminaire
Low (0-30°)	6986	21%
Medium (30-60°)	19172	59%
High (60-80°)	5875	18%
Very High (80-90°)	534	2%
Uplight (90-180°)	0	0%
Total Flux	32566	100%

ISO Footcandle

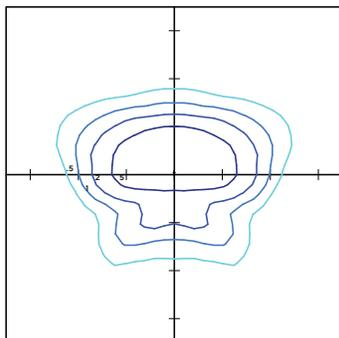

POLAR CURVE

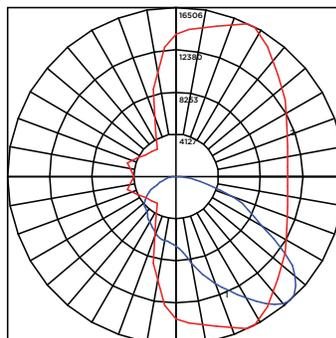

25' Mounting Height/ 25' Grid Spacing

■ 5 FC ■ 2 FC ■ 1 FC ■ 0.5 FC

MRM-LED-30L-SIL-AM-40-70CRI

Luminaire Data	
Type AM Distribution	
Description	4000 Kelvin, 70 CRI
Delivered Lumens	32,960
Watts	232
Efficacy	142
IES Type	Type III - Very Short
BUG Rating	B3-U0-G3

Zonal Lumen Summary		
Zone	Lumens	% Luminaire
Low (0-30°)	6363	19%
Medium (30-60°)	22026	67%
High (60-80°)	4192	13%
Very High (80-90°)	379	1%
Uplight (90-180°)	0	0%
Total Flux	32960	100%

ISO Footcandle

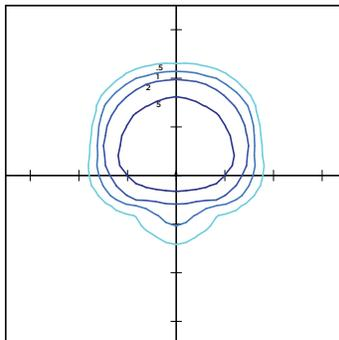

POLAR CURVE

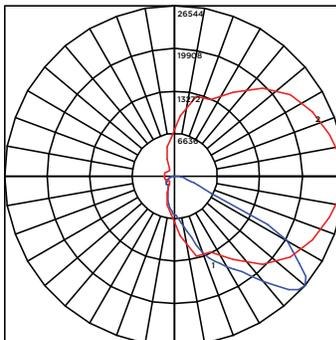

25' Mounting Height/ 25' Grid Spacing

■ 5 FC ■ 2 FC ■ 1 FC ■ 0.5 FC

DESCRIPTION

Recessed 6-inch LED downlight provides narrow, medium or wide distribution patterns ideal for general area lighting. Lumen options range from 1000 to 4000 lumens in color temperatures of 2700K, 3000K, 3500K, and 4000K; in 80 or 90CRI. Luminaire is airtight and can be installed in new construction or below the finished ceiling in remodeling applications. Intended for healthcare, hospitality, office spaces, and institutional applications.

Catalog #	HC615D010-HM612840-61MDH	Type
Project	HEB	RD
Comments		Date
Prepared by		

SPECIFICATION FEATURES

Housing Frame

- Boat shaped galvanized steel plaster frame with adjustable plaster lip accommodates 1/2" to 1-1/2" thick ceilings
- May be installed in new construction; may be installed from below the finished (non-accessible) ceiling in remodeling (with mounting bars removed).
- Provided with (2) old work remodel clips to secure the frame to the ceiling

Universal Mounting Bracket

- Mounting bracket adjusts 2" vertically from above the ceiling or thru the aperture
- Use with the included mounting bars or with 1/2" EMT
- Removable to facilitate installation from below the finished ceiling

Mounting Bars

- Captive pre-installed No Fuss™ mounting bars lock to tee grid with screwdriver or pliers
- Centering mechanism allows for consistent positioning of fixtures

LED Module

- Proximity phosphors over chip on board LEDs provide a uniform source with high efficiency and no pixilation
- Available in 80 or 90 CRI minimum, accuracy within 3 SDCM provides color uniformity
- 90 CRI option: R9>50 (refer to photometry section)
- Correlated color temperature options
 - 2700K
 - 3000K
 - 3500K
 - 4000K
- Passive thermal management achieves L70 at 50,000 hours in IC and non IC applications
- Integral diffuse lens provides visual shielding
- Integral connector allows quick connection to housing flex

Lumen Options

- Nominal lumen values
 - 1000 lm
 - 1500 lm
 - 2000 lm
 - 3000 lm
 - 4000 lm

Reflector

- Self-flanged aluminum reflectors are available in narrow, medium or wide distribution patterns
- Medium distribution polymer non-conductive matte white reflector may be used to meet local codes for 'dead front' applications (Non-IC, 3000 lumen max.)
- Wall wash reflector features a rotatable insert assembly with integral linear spread lens for precise alignment of vertical illumination.
- Reflector attaches to LED module with (3) speed clamps
- Multiple painted or plated finishes are available

Reflector / Module Retention

- Reflector / module assembly is securely retained in the housing with (2) torsion springs

Driver

- Field replaceable constant current driver provides low noise operation
- UNV 120-277VAC 50/60Hz input standard
- 347VAC 50/60Hz input option (Canada only)
- Continuous, flicker-free 1% dimming with 0-10V analog control
- Optional low voltage DC driver for use with Eaton's DLVP distributed low voltage power system combines power and control

Emergency Option

- Provides 90 minutes of standby lighting meeting most life safety codes for egress lighting
- Available with integral or remote charge indicator and test switch

Connected Lighting System Options

- WaveLinX tile mount daylight sensor includes control module, sensor and cable providing comprehensive lighting control
- LumaWatt Pro (powered by Enlighted) wireless tile mount sensor and control kit

Junction Box

- Galvanized steel junction box
- 20 in³ internal volume excluding voltage barrier
- 25 in³ internal total volume
- Voltage divider for 0-10V dimming wires [occupies (1) 1/2" pry-out space]
- Listed for (8) #12 AWG (four in, four out) 90° C conductors and feed-thru branch wiring
- (3) 1/2" and (2) 3/4" trade size pry-outs available
- (3) 4-port push wire nuts for mains voltage, with 1-port for fixture connection

Compliance

- cULus Listed/Classified, wet location labeled for covered ceilings
- IP20 - Above finished ceiling; IP65 - Below finished ceiling
- Non-IC rated 3000, 4000 lumen models. Insulation must be kept 3" from top and sides.
- IC rated 1000, 1500, 2000 lumen models, and suitable for direct contact to air permeable insulation
- Not for use in direct contact with spray foam insulation, consult NEMA LSD57-2013
- Airtight per ASTM-E283-04
- Suitable for use in clothes closets when installed in accordance with the NEC 410.16 spacing requirements
- EMI/RFI emissions FCC CFR Title 47 Part 15 Class A at 120/277V & Class B at 120V
- Contains no mercury or lead and RoHS compliant
- Photometric testing in accordance with IES LM-79-08
- Lumen maintenance projections in accordance with IES LM-80-08 and TM-21-11
- 1000, 1500 and 2000 lumen 90CRI ICAT models may be used to comply with State of California Title 24 residential code, with JA8-2016-E database certification
- May be used to comply with State of California Title 24 non-residential code, as a dimmable LED luminaire
- ENERGY STAR® certified, reference certified light fixtures database

Warranty

- Five year limited warranty, consult website for details.
www.eaton.com/lighting/legal



HC6
Frame

HM6
LED Module

61
61PS

Series Reflectors

6-inch Lens Downlight
and Lens Wall Wash

1000/1500/2000/
3000/4000 Lumen



Mirada Medium Outdoor LED Area Light

Type : _____

 Have questions? Call us at (800) 436-7800

PRODUCT DIMENSIONS

[Back to Quick Links](#)

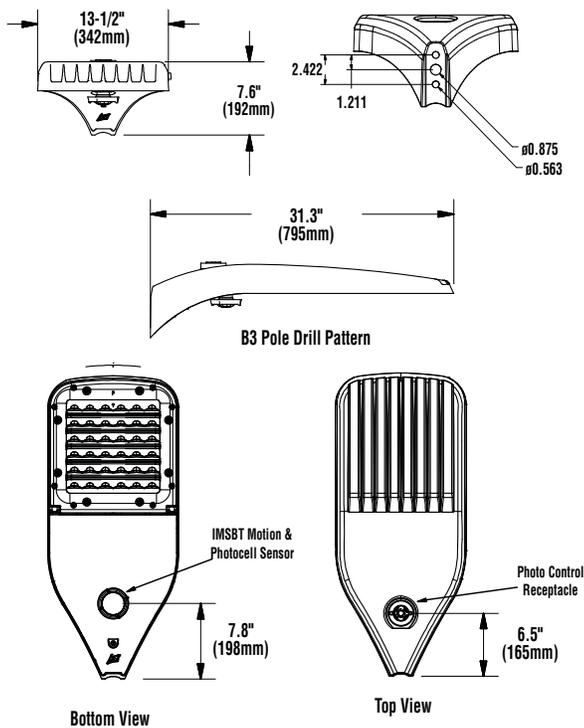

LUMINAIRE EPA CHART - MRM									
Tilt Degree		0°	30°	45°	Tilt Degree	0°	30°	45°	
	Single	0.5	1.5	1.9		T90°	1.0	2.5	2.8
	D180°	1.0	1.5	1.9		TN120°	1.0	3.3	3.9
	D90°	0.8	1.9	2.3		Q90°	1.0	2.5	2.8

CONTROLS

AirLink Wireless Lighting Controller

The AirLink integrated controller is a California Title 24 compliant lighting controller that provides real-time light monitoring and control with utility-grade power monitoring. It includes a 24V sensor input and power supply to connect a sensor into the outdoor AirLink wireless lighting system. The wireless integrated controller is compatible with this fixture.

Click the link below to learn more details about AirLink.

<https://www.lsicorp.com/wp-content/uploads/documents/products/airlink-outdoor-specsheet.pdf>

Integral Bluetooth™ Motion and Photocell Sensor (IMSBT)

Slim low profile sensor provides multi-level control based on motion and/or daylight. Sensor controls 0-10 VDC LED drivers and is rated for cold and wet locations (-30° C to 70° C). Two unique PIR lenses are available and used based on fixture mounting height. All control parameters are adjustable via an iOS or Android App capable of storing and transmitting sensor profiles.

Click the link below to learn more details about IMSBT.

<https://www.lsicorp.com/wp-content/uploads/documents/products/imsbt-specsheet.pdf>

AirLink Blue

Wireless Bluetooth Mesh Outdoor Lighting Control System that provides energy savings, code compliance and enhanced safety/security for parking lots and parking garages. Three key components; Bluetooth wireless radio/sensor controller, Time Keeper and an iOS App. Capable of grouping multiple fixtures and sensors as well as scheduling time-based events by zone. Radio/Sensor Controller is factory integrated into Area/Site, Wall Mounted, Parking Garage and Canopy luminaires.

Click the link below to learn more details about AirLink Blue.

<https://www.lsicorp.com/product/airlink-blue/>

ENERGY DATA

Series	1000 lumen	
Input Voltage (VAC)	120V	277V
Input Current (A)	0.085	0.042
Input Power (W)	10.1	10.9
In-rush Current (A)	0.644	1.95
In-rush Duration (ms)	0.125	0.24
THDi (%)	8.6	15.6
PF:	≥ 0.90	
(Nominal input 120-277VAC & 100% of rated output power)		
Minimum starting temperature -40°C (-40°F)		
Sound Rating: Class A standards		

Series	1500 lumen	
Input Voltage (VAC)	120V	277V
Input Current (A)	0.119	0.055
Input Power (W)	14.2	14.9
In-rush Current (A)	0.212	0.85
In-rush Duration (ms)	0.28	0.32
THDi (%)	7.8	16.3
PF:	≥ 0.90	
(Nominal input 120-277VAC & 100% of rated output power)		
Minimum starting temperature -40°C (-40°F)		
Sound Rating: Class A standards		

Series	2000 lumen	
Input Voltage (VAC)	120V	277V
Input Current (A)	0.176	0.082
Input Power (W)	21.1	21.4
In-rush Current (A)	0.588	0.624
In-rush Duration (ms)	0.3	0.38
THDi (%)	8.8	11.2
PF:	≥ 0.90	
(Nominal input 120-277VAC & 100% of rated output power)		
Minimum starting temperature -40°C (-40°F)		
Sound Rating: Class A standards		

Series	3000 lumen	
Input Voltage (VAC)	120V	277V
Input Current (A)	0.228	0.102
Input Power (W)	27.2	27
In-rush Current (A)	0.898	1.7
In-rush Duration (ms)	0.36	0.38
THDi (%)	9.7	9.3
PF:	≥ 0.90	
(Nominal input 120-277VAC & 100% of rated output power)		
Minimum starting temperature -40°C (-40°F)		
Sound Rating: Class A standards		

Series	4000 lumen	
Input Voltage (VAC)	120V	277V
Input Current (A)	0.345	0.15
Input Power (W)	41.3	40.7
In-rush Current (A)	1.05	2.23
In-rush Duration (ms)	0.32	0.34
THDi (%)	10.06	14.01
PF:	≥ 0.90	
(Nominal input 120-277VAC & 100% of rated output power)		
Minimum starting temperature -40°C (-40°F)		
Sound Rating: Class A standards		

DIMENSIONS

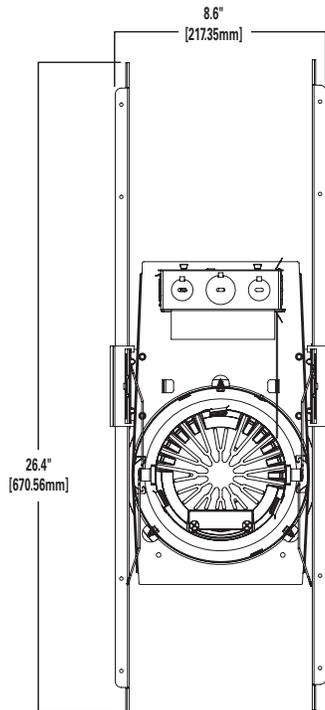

NEW CONSTRUCTION - HIGH LUMEN
3000 AND 4000 LUMEN

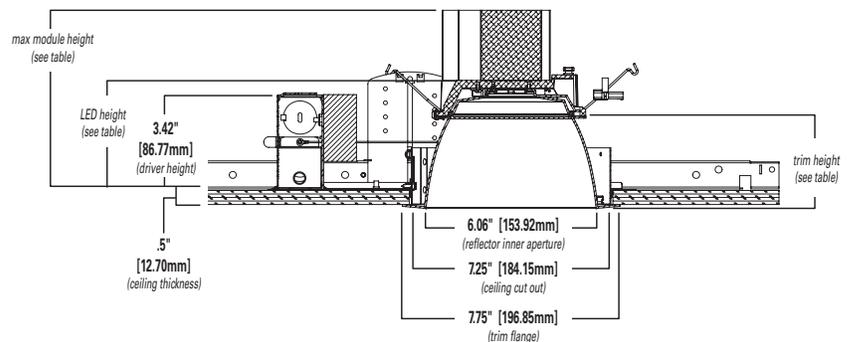

NEW CONSTRUCTION - LOW LUMEN
1000, 1500, AND 2000 LUMENS

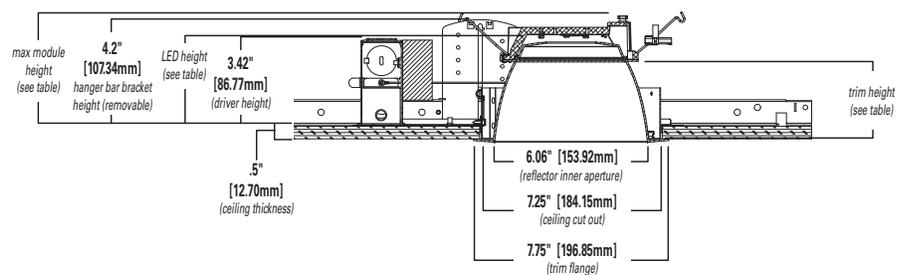

High Lumen (3000 & 4000 Lumens)

Distribution	Max. Module Height	Trim Height	LED Height
Narrow	6.6"	3.4"	3.8"
Medium	6.7"	3.5"	3.9"
Wide	6.5"	3.3"	3.7"
Baffle	6.5"	3.3"	3.7"

Low Lumen (1000, 1500 & 2000 Lumens)*

Distribution	Max. Module Height	Trim Height	LED Height
Narrow	4.5"	3.4"	3.8"
Medium	4.6"	3.5"	3.9"
Wide	4.4"	3.3"	3.7"
Baffle	4.4"	3.3"	3.7"

*Max. height w/hanger bar bracket 4.2"

Ordering Information

Sample Number: HC620D010REM7 – HM612835 - 61MDC

A complete luminaire consists of a housing frame, LED module, and reflector (ordered separately)

Mounting Frame	Lumens	Input / Control	Options	Accessories
HC6 = 6" new construction and remodeler housing	10 = 1000 lumens (nominal) 15 = 1500 lumens (nominal) 20 = 2000 lumens (nominal) 30 = 3000 lumens (nominal) 40 = 4000 lumens (nominal)	D010 = 120-277VAC 50/60Hz 0-10V analog 1%-100% dimming D010347 = 347VAC 50/60Hz 0-10V analog 1%-100% dimming (Canada only) ¹	REM7 = 7 watt emergency module with remote test / indicator light, use with D010 only ¹ REM14 = 14 watt emergency module with remote test / indicator light, use with D010 only ¹ IEM7 = integral 7 watt emergency module with integral test / indicator light, use with D010 only ¹ IEM14 = integral 14 watt emergency module with integral test / indicator light, use with D010 only ¹ LWTPD1 = factory installed LumaWatt Pro wireless tile mount sensor kit, use with D010 only ¹ SWPD1 = factory installed WaveLinX tile mount daylight sensor, includes control module, sensor, and cable, use with D010 only ¹	HB128APK = L channel hanger bar, 26", pair (replacement) RMB22 = Adjustable wood joist mounting bars, pair, extend to 22" long H347 = 347 to 120V step down transformer, 75VA H347200 = 347 to 120V step down transformer, 200VA PORLWTPD1 = Field installed LumaWatt Pro wireless sensor kit, use with D010 only ¹ TMSWPD1 = Field installed WaveLinX wireless sensor kit, use with D010 only ¹
HC6CP = 6" new construction and remodeler housing, CCEA Chicago Plenum rated		DLV = Distributed Low Voltage driver, 1%-100% dimming DLV for use with Eaton's DLVP system only. Refer to DLVP low-voltage power module and DLVP specifications for details. ¹	REM7 = 7 watt emergency module with remote test / indicator light, use with DLV only ^{1, 2} REM14 = 14 watt emergency module with remote test / indicator light, use with DLV only ^{1, 2} IEM7 = integral 7 watt emergency module with integral test / indicator light, use with DLV only ^{1, 2} IEMV14 = integral 14 watt emergency module with integral test / indicator light, use with DLV only ^{1, 2}	

LED Module	Lumens	CRI/CCT
HM6 = 6" LED module	12 =1000, 1500 and 2000 lumens (nominal), use with HC610*, HC615*, HC620* housings 34 =3000 and 4000 lumens (nominal), use with HC630*, HC640* housings	827 = 80 CRI (minimum), 2700K CCT 830 = 80 CRI (minimum), 3000K CCT 835 = 80 CRI (minimum), 3500K CCT 840 = 80 CRI (minimum), 4000K CCT 927 = 90 CRI (minimum), 2700K CCT 930 = 90 CRI (minimum), 3000K CCT 935 = 90 CRI (minimum), 3500K CCT 940 = 90 CRI (minimum), 4000K CCT

Reflector	Distribution ³	Finish	Flange	Accessories
61 = 6" conical reflector	ND = narrow 55° beam angle 0.97 SC MD = medium 60° beam angle 1.10 SC WD = wide 65° beam angle 1.28 SC RWW = rotatable wall wash with linear spread lens	C = Specular clear H = Semi-specular clear W = White (white flange)	Blank = Polished flange standard with C & H reflectors Blank = White flange standard with W reflector WF = White flange option available with C & H reflectors	61RWWPK = rotatable wall wash insert for 6" reflector –replacement part kit

Baffle	Distribution ³	Finish	Flange	Accessories
61 = 6" baffle reflector	WD = wide 65° beam angle 1.28 SC (nominal) RWW = rotatable wall wash with linear spread lens	BB = Black baffle (white flange) WB = White baffle (white flange)	Blank = White flange standard with BB, & WB	61RWWPK = rotatable wall wash insert for 6" reflector –replacement part kit

IEM Reflector	Distribution ³	Finish	Flange	Integral Emergency
61 = 6" IEM reflector for integral emergency only	ND = narrow 55° beam angle 0.97 SC MD = medium 60° beam angle 1.10 SC WD = wide 65° beam angle 1.28 SC	C = Specular clear H = Semi-specular clear W = White (white flange)	Blank = Polished flange standard with C & H reflectors Blank = White flange standard with W reflector WF = White flange option available with C & H reflectors	IEM = Reflector for integral emergency only

IEM Baffle	Distribution ³	Finish	Flange	Integral Emergency
61 = 6" IEM baffle reflector for integral emergency only	WD = wide 65° beam angle 1.28 SC (nominal)	BB = Black baffle (white flange) WB = White baffle (white flange)	Blank = White flange standard with BB, & WB	IEM = Reflector for integral emergency only

Reflector	Distribution ³	Finish	Flange
61PS = 6" non-conductive polymer 'dead front' conical reflector ⁴	MD = medium 60° beam angle 1.10 SC (nominal)	W = White (white flange)	Blank = White flange standard with W reflector

Notes:

1. Not available with CP version
2. ULus for U.S. only
3. Values are nominal, with specular clear reflector, other finishes and field results may vary.
4. 61PS reflector is for Non-IC environment only, and up to 3000 lumens only.

PHOTOMETRY

NARROW DISTRIBUTION - SPECULAR CLEAR FINISH, 2000 LUMEN MODEL, 80 CRI, 3500K

NARROW (55° BEAM*)		CANDLEPOWER DISTRIBUTION		CONE OF LIGHT				CANDELA TABLE		ZONAL LUMEN SUMMARY			LUMINANCE	
Test Number	P285970							Degrees Vertical	Candela	Zone	Lumens	% Fixture	Average Candela Degrees	Average 0° Luminance
Housing	HC620D010							0	1962	0-30	1385	72.1	45	8706
Module	HM612835							5	1962	0-40	1796	93.5	55	1223
Reflector	61NDC							15	1975	0-60	1915	99.7	65	337
Lumens	1920 Lm							25	1434	0-90	1920	100	75	551
Efficacy	96 Lm/W	35	671	90-180	0	0	85	0						
SC	0.97	45	112											
UGR	11.7	55	13											
		65	3											
		75	3											
		85	0											
		90	0											
		MH	FC	L	W									
		5.5'	64.9	5.2	5.2									
		7'	40	6.8	6.8									
		8'	30.7	7.6	7.6									
		9'	24.2	8.6	8.6									
		10'	19.6	9.6	9.6									
		12'	13.6	11.6	11.6									

MEDIUM DISTRIBUTION - SPECULAR CLEAR FINISH, 2000 LUMEN MODEL, 80 CRI, 3500K

MEDIUM (60° BEAM*)		CANDLEPOWER DISTRIBUTION		CONE OF LIGHT				CANDELA TABLE		ZONAL LUMEN SUMMARY			LUMINANCE	
Test Number	P286170							Degrees Vertical	Candela	Zone	Lumens	% Fixture	Average Candela Degrees	Average 0° Luminance
Housing	HC620D010							0	1642	0-30	1387	70.8	45	9296
Module	HM612835							5	1660	0-40	1821	93	55	1462
Reflector	61MDC							15	1854	0-60	1951	99.6	65	662
Lumens	1959 Lm							25	1576	0-90	1959	100	75	551
Efficacy	97.9 Lm/W	35	699	90-180	0	0	85	0						
SC	1.10	45	120											
UGR	11.8	55	15											
		65	5											
		75	3											
		85	0											
		90	0											
		MH	FC	L	W									
		5.5'	55.2	5.8	5.8									
		7'	34.1	7.6	7.6									
		8'	26.1	8.6	8.6									
		9'	20.6	9.6	9.6									
		10'	16.7	10.8	10.8									
		12'	11.6	13	13									

WIDE DISTRIBUTION - SPECULAR CLEAR FINISH, 2000 LUMEN MODEL, 80 CRI, 3500K

WIDE (65° BEAM*)		CANDLEPOWER DISTRIBUTION		CONE OF LIGHT				CANDELA TABLE		ZONAL LUMEN SUMMARY			LUMINANCE	
Test Number	P286370							Degrees Vertical	Candela	Zone	Lumens	% Fixture	Average Candela Degrees	Average 0° Luminance
Housing	HC620D010							0	1341	0-30	1282	62.7	45	15614
Module	HM612835							5	1349	0-40	1835	89.7	55	2676
Reflector	61WDC							15	1466	0-60	2037	99.6	65	662
Lumens	2045 Lm							25	1642	0-90	2045	100	75	530
Efficacy	102.3 Lm/W	35	877	90-180	0	0	85	0						
SC	1.28	45	201											
UGR	11.6	55	28											
		65	5											
		75	2											
		85	0											
		90	0											
		MH	FC	L	W									
		5.5'	44.3	7	7									
		7'	27.4	8.8	8.8									
		8'	21	10.2	10.2									
		9'	16.6	11.4	11.4									
		10'	13.4	12.6	12.6									
		12'	9.3	15.2	15.2									

*Value are nominal with specular clear reflectors, other finishes and field results may vary.
SC = Spacing Criteria
UGR = Unified Glare Rating

Photometric Multipliers (nominal lumen values)

1000 Lumen	1500 Lumen	2000 Lumen	3000 Lumen	4000 Lumen
0.52	0.72	1.00	1.44	2.02

Multipliers for relative lumen values with other series models.

CCT Multipliers – 80CRI

2700K	3000K	3500K	4000K
0.93	0.95	1.00	1.05

Multipliers for relative lumen values with other series color temperatures.

Color Finish Multipliers

Finish code	C	H	W/WB	BB
Finish	Specular Clear	Semi-Specular	Matte White White Baffle	Black Baffle
Multiplier	1.00	0.91	0.92	0.84

Multipliers for relative lumen values with other color finishes.

CCT Multipliers – 90CRI

2700K	3000K	3500K	4000K
0.75	0.82	0.90	0.89

Multipliers for relative lumen values with other series color temperatures.

PHOTOMETRY

WALL WASH DISTRIBUTION - SPECULAR CLEAR FINISH, 2000 LUMEN MODEL, 80 CRI, 3500K

WALL WASH	
Test Number	P286650
Housing	HC620D010
Module	HM612835
Reflector	61RWWC
Lumens	1798 Lm
Efficacy	89.9 Lm/W
SC	1.23

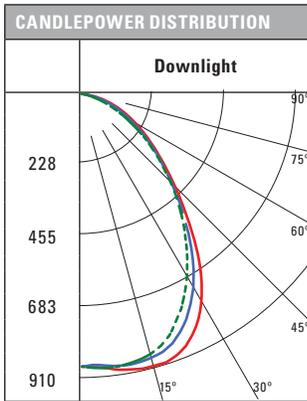

CANDELA TABLE	
Degrees Vertical	Candela
0	882
5	890
15	910
25	854
35	665
45	431
55	270
65	161
75	74
85	10
90	0

ZONAL LUMEN SUMMARY		
Zone	Lumens	% Fixture
0-30	696	38.7
0-40	1079	60
0-60	1629	90.6
0-90	1798	100
90-180	0	0
0-180	1798	100

LUMINANCE	
Average Candela Degrees	Average 0° Luminance
45	33399
55	25825
65	20832
75	15653
85	6416

SC = Spacing Criteria, nominal for specular clear reflector, other finishes and field results may vary.

SINGLE UNIT FOOTCANDLES							
2.5' from wall (distance from fixture along wall)							
1	16.8	12	5.4	2	0.7	0.2	0.1
2	24.7	19.2	10.5	4.9	2.2	1	0.5
3	22.8	18.6	11.4	6.2	3.2	1.7	0.9
4	17.5	15	10.3	6.2	3.6	2	1.2
5	11.9	10.7	8.2	5.5	3.4	2.1	1.3
6	8	7.4	6.1	4.5	3.1	2	1.3
7	5.5	5.2	4.5	3.6	2.6	1.9	1.3
8	3.9	3.7	3.3	2.8	2.2	1.6	1.2
9	2.8	2.7	2.5	2.2	1.8	1.4	1.1
10	2.1	2	1.9	1.7	1.5	1.2	0.9

MULTIPLE UNIT FOOTCANDLES									
2.5' from wall (distance from fixture along wall)			2.5' from wall (distance from fixture along wall)			2.5' from wall (distance from fixture along wall)			
1	18.8	16.6	18.8	17.5	10.7	17.5	26.8	20.9	26.8
2	29.5	29.2	29.5	26	22.9	26	21	20.5	21
3	29	29.8	29	15.4	16.3	15.4	11.1	12.2	11.1
4	23.7	25.3	23.7	8.1	9	8.1	6.1	6.7	6.1
5	17.4	19.2	17.4	4.6	5	4.6	3.5	3.8	3.5
6	12.5	13.7	12.5						
7	9.1	9.8	9.1						
8	6.7	7.1	6.7						
9	5	5.3	5						
10	3.8	4	3.8						

Photometric Multipliers (nominal lumen values)

1000 Lumen	1500 Lumen	2000 Lumen	3000 Lumen	4000 Lumen
0.52	0.72	1.00	1.44	2.02

Multipliers for relative lumen values with other series models.

Color Finish Multipliers

Finish code	C	H	W/WB	BB
Finish	Specular Clear	Semi-Specular	Matte White White Baffle	Black Baffle
Multiplier	1.00	0.91	0.92	0.84

Multipliers for relative lumen values with other color finishes.

CCT Multipliers – 80CRI

2700K	3000K	3500K	4000K
0.93	0.95	1.00	1.05

Multipliers for relative lumen values with other series color temperatures.

CCT Multipliers – 90CRI

2700K	3000K	3500K	4000K
0.75	0.82	0.90	0.89

Multipliers for relative lumen values with other series color temperatures.

COLOR METRICS

TM-30-15 & CRI/CIE (3500K)

80 CRI Color Metric Summary - 3500K*

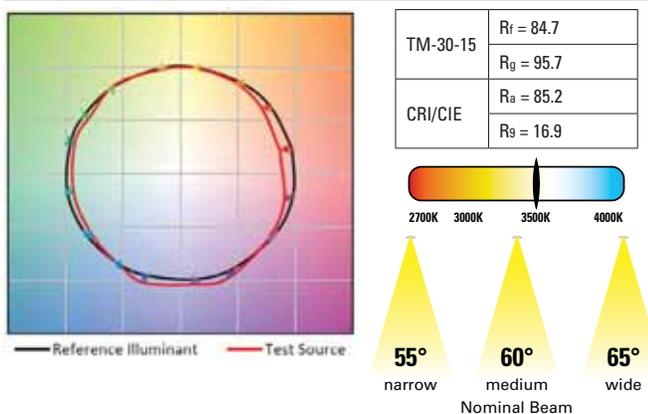

90 CRI Color Metric Summary - 3500K*

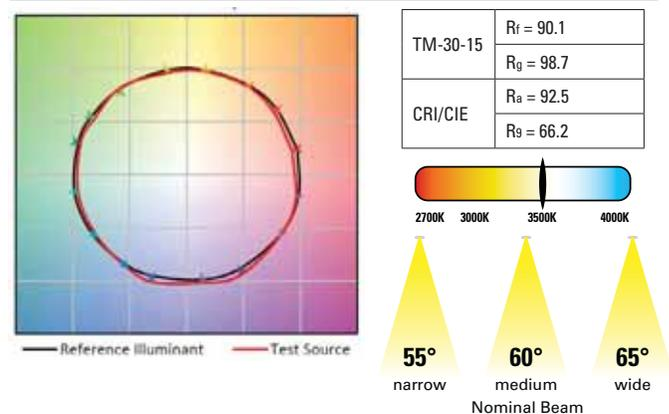

DESCRIPTION

The Lumark Axcent LED wall mount luminaire provides a flush-mounted, architectural design with high performing, energy-efficient illumination resulting in up to 95% energy and maintenance savings over traditional sources. The die-cast aluminum construction along with stainless steel hardware, gasketed housing, and sealed optical compartment make the Axcent impervious to contaminants. The Axcent replaces 70W to 450W metal halide equivalents making it ideal for pathway illumination, building entrances, vehicle ramps, schools, tunnels, stairways, loading docks and floodlighting applications.

SPECIFICATION FEATURES

Construction

Low-profile LED design with rugged die-cast aluminum housing. Matching housing styles incorporate both a full cutoff and refractive lens design. External fin design on the back of the fixture extracts heat from the surface resulting in a thermally optimize design for longer luminaire life. One-piece silicone gasket seals the fixture, keeping out moisture and dusts in compliance with IP66 rating. The fixture is 3G vibration rated (ANSI C136.31) and UL/cUL listed ensuring reliability and durability in wall mount applications.

Optical

Silicone-sealed optical LED chamber incorporates a custom engineered reflector providing high-efficiency illumination. Refractive lens models incorporate a molded lens assembly designed for maximum forward throw. Optional glare free lens is available for visual comfort at reduced lumen values. Available in Type IV distribution with lumen packages ranging from 1,800 to 17,300 nominal lumens. Light engine configurations consist of high-efficiency, discrete LEDs mounted to metal-core circuit boards to maximize heat

dissipation and promote long life. Offered in standard 4000K (+/- 275K) CCT and minimum 70 CRI. Optional 5000K CCT / 70CRI min and 3000K / 80CRI min are available.

Electrical

LED driver is mounted to the die-cast aluminum housing for optimal heat sinking. Integral LED electronic driver incorporates 6kV surge protection. Class 1 electronic drivers have a power factor >90% and THD<20%. 120-277V 50/60Hz standard operation with optional 347V 60Hz or 480V 60Hz options available. 480V is compatible for use with 480V Wye systems only. 0-10V dimming driver is standard with leads external to the fixture to accommodate controls capability such a dimming and occupancy. 10kV/10kA surge protection option is available.

Mounting

Steel wedge mounting plate fits directly to 4" standard j-box or directly to wall with the "Hook-N-Lock" mechanism for quick installation. Secure with two captive, corrosion resistant, stainless steel set screws, which are concealed but accessible from bottom of fixture. Optional floodlight kits available in slipfitter,

Catalog #	AXCL6A	Type
Project	HEB	X5/X6
Comments		Date
Prepared by		

knuckle and trunion mount configurations. Optional pole mount configuration provides a quick-mount solution to round and square poles. The easy installation arm accommodates multiple drill patterns ranging from 1-1/2" to 4-7/8".

Emergency Egress

Optional integral cold weather battery emergency egress includes emergency operation test switch, an AC-ON indicator light and a premium, maintenance-free battery pack. The separate emergency lighting LEDs are wired to provided redundant emergency lighting. Listed to UL Standard 924, Emergency Lighting.

Finish

The Axcent is protected with five state super TGIC polyester powder coat paint in carbon bronze and five other color finishes. Super TGIC power coat paint finishes withstand extreme climate conditions while providing optimal color and gloss retention of the installed life.

Warranty

Five-year warranty.



AXCS / AXCL AXCENT

14-123W
LED

APPLICATIONS:
WALL / SURFACE / INVERTED
FLOODLIGHTING / PATHWAY /
SITE LIGHTING

**CERTIFICATION DATA**

3G Vibration Rated
DesignLights Consortium® Qualified*
FCC Class A
IP66 Rated
ISO9001, UL/cUL Wet Location Listed
LM79/LM80 Compliant
ROHS Compliant
Title 24 Compliant
UL924 Listed (CBP Models)

TECHNICAL DATA

-40°C Minimum Ambient Temperature
+40°C Maximum Ambient Temperature
External Supply Wiring 90°C Minimum

SHIPPING DATA:

Approximate Net Weight:
Small fixture=5 lbs. [2.36 kgs.]
Small with sensor or CBP=10 lbs. [4.40 kgs.]
Large fixture=12 lbs. [5.45 kgs.]
Large with sensor or CBP=17 lbs. [7.73 kgs.]
Large with sensor & CBP=21 lbs. [9.54 kgs.]



TD514036EN
September 25, 2019 8:03 AM

DIMENSIONS

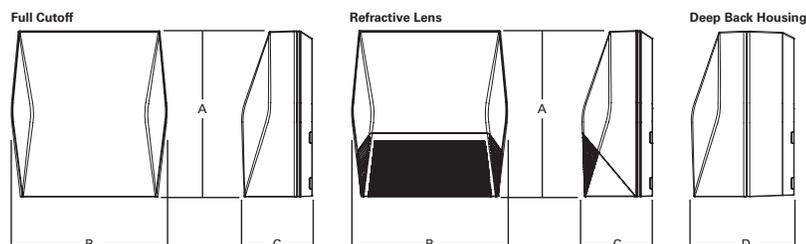
**Dimensional Data**

	AXCS Small	AXCL Large
A	8" [202mm]	11-1/2" [292mm]
B	7-1/2" [190mm]	10-3/4" [273mm]
C	3-5/8" [94mm]	4-7/8" [124mm]
D	6-1/8" [155mm]	7-1/8" [181mm]

MOUNTING OPTIONS

Slipfitter Mount (Small)
 Tenon OD: 2-3/8" | EPA: 0.60

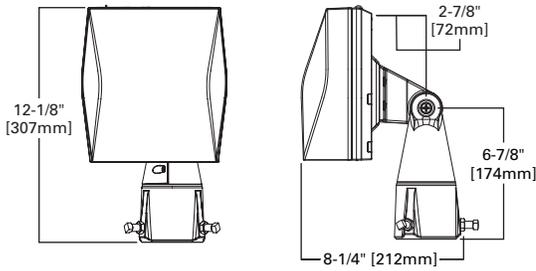

Knuckle Mount (Small)

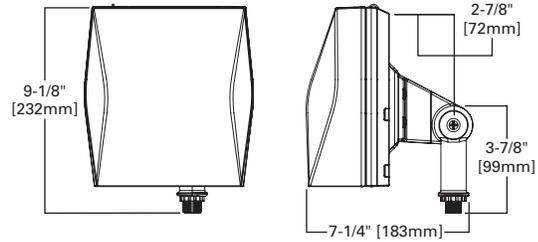

Trunnion Mount (Small)

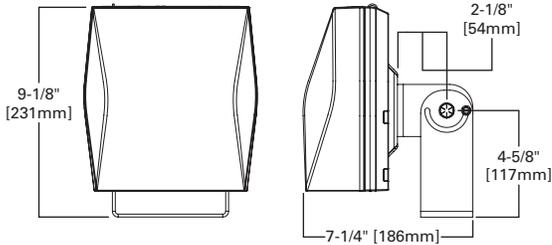

Slipfitter Mount (Large)
 Tenon OD: 2-3/8" to 2-7/8" | EPA: 1.10

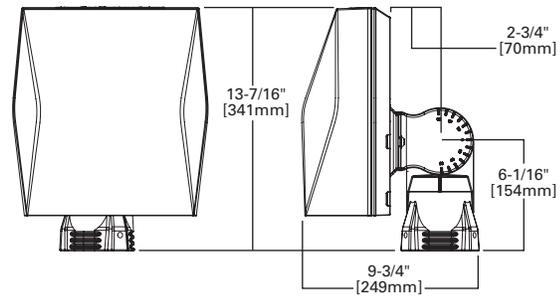

Trunnion Mount (Large)

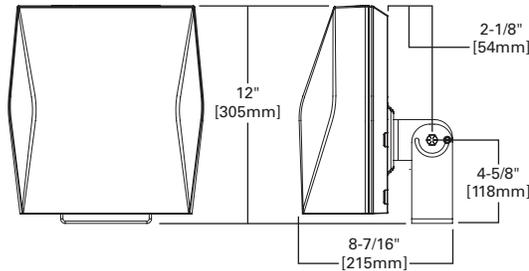

Pole Mount Arm (Shown with Large fixture) Drill Pattern
 EPA: 1.1

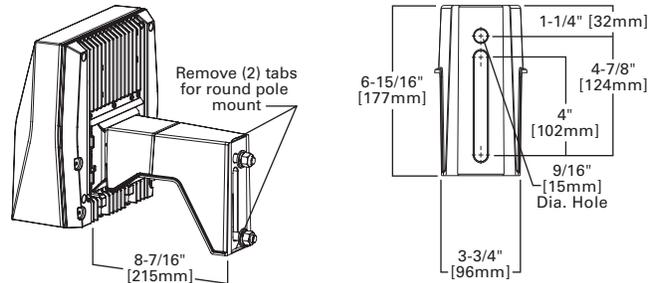

Trunnion Mount Detail

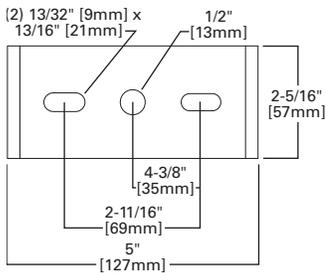

Through-branch Wiring (Available through rated junction box - supplied by others)

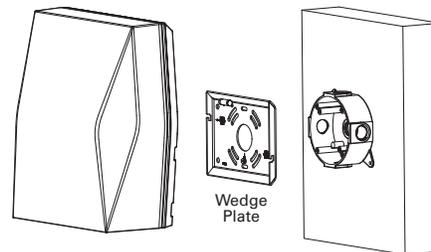

Wall Mount Plate Detail (Small)

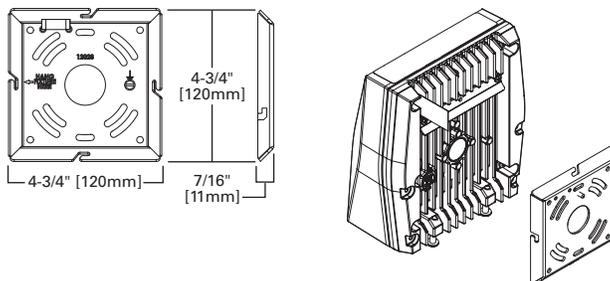

Wall Mount Plate Detail (Large)

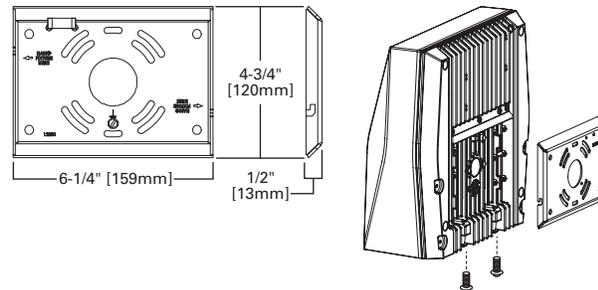

CONTROL OPTIONS

LumaWatt Pro Sensor

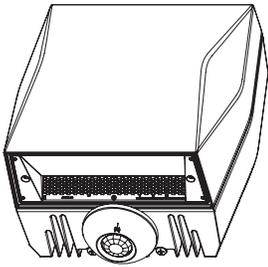

Occupancy Sensor

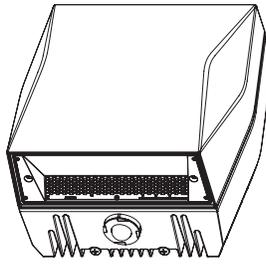

Button Photocontrol

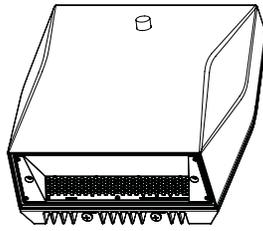

VANDAL SHIELD AND WIRE GUARD OPTIONS

Vandal Shield

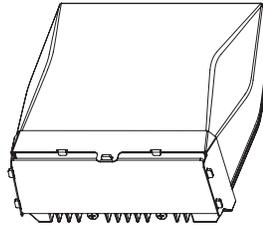

Wire Guard

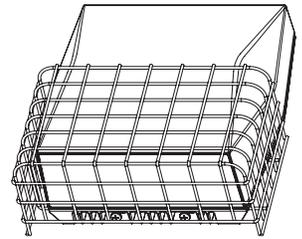

CONTROL OPTIONS

0-10V

This fixture is offered standard with 0-10V dimming driver(s) for use with a lighting control panel or other control method.

Photocontrol (PC1, PC2, and PC)

Optional button-type photocontrol provides a flexible solution to enable “dusk-to-dawn” lighting by sensing light levels.

After Hours Dim (AHD)

This feature allows photocontrol-enabled luminaires to achieve additional energy savings by dimming during scheduled portions of the night. The dimming profile will automatically take effect after a “dusk-to-dawn” period has been calculated from the photocontrol input. Specify the desired dimming profile for a simple, factory-shipped dimming solution requiring no external control wiring. Reference the After Hours Dim supplemental guide for additional information.

Dimming Occupancy Sensor (MSP/DIM-LXX and MSP-LXX)

These sensors are factory installed in the luminaire housing. When the MSP/DIM-LXX sensor option is selected, the occupancy sensor is connected to a dimming driver and the entire luminaire dims when there is no activity detected. When activity is detected, the luminaire returns to full light output. The MSP/DIM sensor is factory preset to dim down to approximately 50 percent power with a time delay of five minutes. The MSP-LXX sensor is factory preset to turn the luminaire off after five minutes of no activity.

These occupancy sensors includes an integrated photocell that can be activated with the ISHH-01 accessory for “dusk-to-dawn” control or daylight harvesting - the factory preset is OFF. The ISHH-01 is a wireless tool utilized for changing the dimming level, time delay, sensitivity and other parameters.

A variety of sensor lens are available to optimize the coverage pattern for mounting heights from 8’-30’.

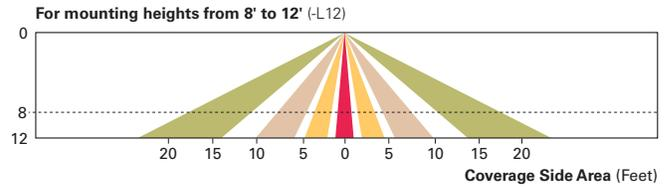
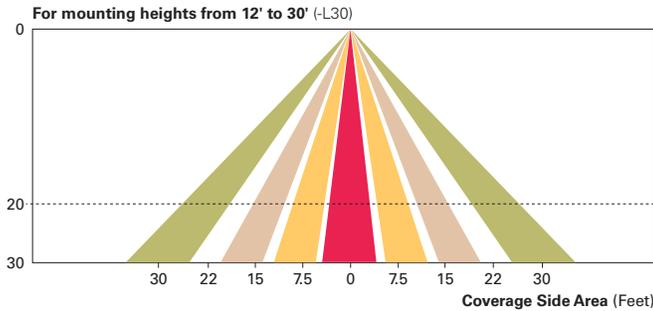

LumaWatt Pro Wireless Control and Monitoring System (LWR-LW and LWR-LN)

The LumaWatt Pro system is a peer-to-peer wireless network of luminaire-integral sensors for any sized project. Each sensor is capable of motion and photo sensing, metering power consumption and wireless communication. The end-user can securely create and manage sensor profiles with browser-based management software. The software will automatically broadcast to the sensors via wireless gateways for zone-based and individual luminaire control. The LumaWatt Pro software provides smart building solutions by utilizing the sensor to provide easy-to-use dashboard and analytic capabilities such as improved energy savings, traffic flow analysis, building management software integration and more.

For additional details, refer to the LumaWatt Pro product guides.

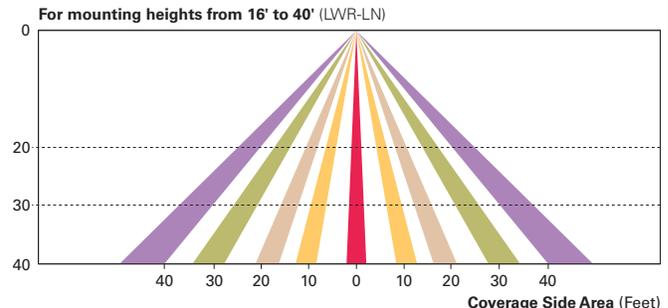
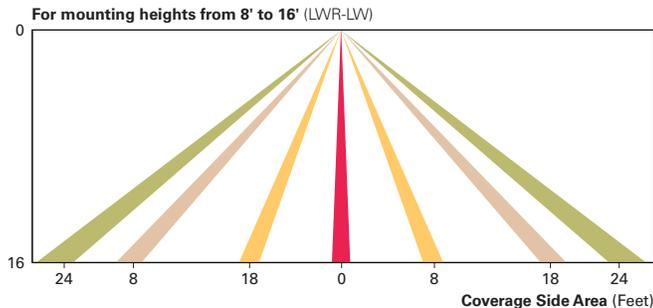

POWER AND LUMENS (AXCENT SMALL)

Light Engine		AXCS1A	AXCS2A	AXCS3A	AXCS4A	AXCS5A
Power (Watts)		14	21	27	44	52
Input Current @ 120V (A)		0.12	0.18	0.23	0.37	0.43
Input Current @ 240V (A)		0.06	0.09	0.11	0.18	0.22
Input Current @ 277V (A)		0.05	0.08	0.10	0.16	0.19
Input Current @ 347V (A)		0.04	0.06	0.08	0.13	0.15
Input Current @ 480V (A)		0.03	0.04	0.06	0.09	0.11
Configuration						
Full Cutoff	4000K/5000K Lumens	1,806	2,561	3,537	5,520	6,300
	3000K Lumens	1,526	2,164	2,989	4,665	5,324
	BUG Rating	B1-U0-G0	B1-U0-G0	B1-U0-G0	B2-U0-G1	B2-U0-G1
Refractive Lens	4000K/5000K Lumens	1,915	2,716	3,704	5,858	6,699
	3000K Lumens	1,618	2,295	3,130	4,950	5,661
	BUG Rating	B1-U3-G2	B1-U3-G2	B1-U3-G2	B1-U4-G3	B1-U4-G3

LUMEN MAINTENANCE (AXCENT SMALL)

Ambient Temperature	TM-21 Lumen Maintenance (72,000 Hours)	Theoretical L70 (72,000 Hours)
Up to 3A		
25°C	90%	246,000
40°C	90%	225,000
50°C	89%	195,000
Up to 5A		
25°C	89%	240,000
40°C	88%	223,000
50°C	87%	186,000

POWER AND LUMENS (AXCENT LARGE)

Light Engine		AXCL6A	AXCL8A	AXCL10A	AXCL12A
Power (Watts)		56	72	102	123
Input Current @ 120V (A)		0.44	0.60	0.83	1.01
Input Current @ 240V (A)		0.22	0.31	0.41	0.51
Input Current @ 277V (A)		0.20	0.27	0.36	0.45
Input Current @ 347V (A)		0.17	0.22	0.30	0.37
Input Current @ 480V (A)		0.13	0.16	0.22	0.27
Configuration					
Full Cutoff	4000K Lumens	7,594	9,696	13,283	16,823
	5000K Rating	7,465	9,531	13,058	16,538
	3000K Lumens	6,619	8,450	11,577	14,662
	BUG Rating	B1-U0-G1	B1-U0-G1	B3-U0-G2	B3-U0-G2
Refractive Lens	4000K Lumens	7,809	9,970	13,641	17,346
	5000K Rating	7,689	9,817	13,450	17,034
	3000K Lumens	6,817	8,704	11,924	15,102
	BUG Rating	B1-U4-G4	B2-U5-G5	B2-U5-G5	B2-U5-G5

LUMEN MAINTENANCE (AXCENT LARGE)

Ambient Temperature	TM-21 Lumen Maintenance (72,000 Hours)	Theoretical L70 (72,000 Hours)
Up to 8A		
25°C	94%	556,000
40°C	94%	556,000
50°C	92%	340,000
Up to 10A		
25°C	94%	556,000
40°C	94%	478,000
50°C	87%	207,000
Up to 12A		
25°C	94%	151,000
40°C	81%	125,000

LUMEN MULTIPLIER

Ambient Temperature	Lumen Multiplier
10°C	1.02
15°C	1.01
25°C	1.00
40°C	0.97

POWER AND LUMENS (SMALL + CBP)

Light Engine		AXCS1A	AXCS2A	AXCS3A	AXCS4A
Power (Watts)		18	25	31	48
Input Current @ 120V (A)		0.15	0.21	0.26	0.40
Input Current @ 240V (A)		0.08	0.11	0.13	0.20
Input Current @ 277V (A)		0.07	0.09	0.11	0.18
Configuration					
Full Cutoff	4000K/5000K Lumens	629	587	647	570
	3000K Lumens	531	496	547	482
Refractive Lens	4000K/5000K Lumens	667	623	686	605
	3000K Lumens	563	526	580	511

Note: Power and current based on full power consumption while CBP is charging. Lumen outputs are while operating in emergency mode only.

POWER AND LUMENS (LARGE + CBP)

Light Engine		AXCL6A	AXCL8A	AXCL10A
Power (Watts)		81	97	127
Input Current @ 120V (A)		0.65	0.81	1.04
Input Current @ 240V (A)		0.33	0.41	0.52
Input Current @ 277V (A)		0.29	0.36	0.45
Configuration				
Full Cutoff	4000K/5000K Lumens	1,340		
	3000K Lumens	1,168		
Refractive Lens	4000K/5000K Lumens	1,380		
	3000K Lumens	1,203		

Note: Power and current based on full power consumption while CBP is charging. Lumen outputs are while operating in emergency mode only.

ORDERING INFORMATION

Sample Number: AXCS1A-AP-347V

Model Series ¹	LED Color Temperature	Color	Options (Add as Suffix)
Full Cutoff AXCS1A=14W AXCS2A=21W AXCS3A=27W AXCS4A=44W AXCS5A=52W AXCL6A=56W AXCL8A=72W AXCL10A=102W AXCL12A=123W Refractive Lens AXCS1ARL=14W AXCS2ARL=21W AXCS3ARL=27W AXCS4ARL=44W AXCS5ARL=52W AXCL6ARL=56W AXCL8ARL=72W AXCL10ARL=102W AXCL12ARL=123W	[Blank]=4000K, Neutral C=5000K, Cool W=3000K, Warm	[Blank]=Carbon Bronze (Standard) WT=Summit White BK=Black AP=Grey GM=Graphite Metallic DP=Dark Platinum	347V=347V ² 480V=480V ² PC1=Photocontrol 120V ^{3,4,5} PC2=Photocontrol 208-277V, 347V, 480V ^{4,5,6} PC=Photocontrol 120-277V, 347V, 480V ^{4,7,8} KKIT=Knuckle Floodlight Mount ⁷ TRNKIT=Trunnion Floodlight Mount SFKIT=Slipfitter Floodlight Mount PMAKIT=Pole Mount Arm LWR-LW=LumaWatt Pro Wireless Sensor, Wide Lens for 8' - 16' Mounting Height ^{4,9} LWR-LN=LumaWatt Pro Wireless Sensor, Narrow Lens for 16' - 40' Mounting Height ^{4,9} MSP/DIM-L12=Integrated Sensor for Dimming Operation, 8' - 12' Mounting Height ^{4,9,10} MSP/DIM-L30=Integrated Sensor for Dimming Operation, 12' - 30' Mounting Height ^{4,9,10} MSP-L12=Integrated Sensor for ON/OFF Operation, 8' - 12' Mounting Height ^{4,9,10} MSP-L30=Integrated Sensor for ON/OFF Operation, 12' - 30' Mounting Height ^{4,9,10} CBP=Cold Weather Battery Pack ^{3,11,12,13,14,15} 10K=10kV/10kA Surge Protection HA=50°C High Ambient ^{12,16} GRF=Glare Reducing Lens ¹⁷ AHD145=After Hours Dim, 5 Hours ^{5,18} AHD245=After Hours Dim, 6 Hours ^{5,18} AHD255=After Hours Dim, 7 Hours ^{5,18} AHD355=After Hours Dim, 8 Hours ^{5,18}

Accessories (Order Separately) ¹⁹

VS/AXCS=Vandal Shield Axcent Small ^{7,20}
 VS/AXCS-MS=Vandal Shield Axcent Small (With Motion Sensor) ^{7,20}
 WG/AXCS=Wire Guard Axcent Small ⁷
 WG/AXCS-MS=Wire Guard Axcent Small (With Motion Sensor) ⁷
 VS/AXCL=Vandal Shield Axcent Large ^{5,20}
 VS/AXCL-MS=Vandal Shield Axcent (With Motion Sensor) ^{5,20}
 WG/AXCL=Wire Guard Axcent Large ⁵
 WG/AXCL-MS=Wire Guard Axcent (With Motion Sensor) ⁵
 KKIT/AXCS-XX=Knuckle and Visor Floodlight Kit (For Axcent Small) ⁷
 SFKIT/AXCS-XX=Slipfitter Floodlight Kit (For Axcent Small) ⁷
 TRNKIT/AXCS-XX=Trunnion and Visor Floodlight Kit (For Axcent Small) ⁷
 TRNKIT-XX=Trunnion Floodlight Kit (For Axcent Large) ⁵
 SFKIT-XX=Slipfitter Floodlight Kit (For Axcent Large) ⁵
 PMAKIT-XX=Pole Mount Kit
 ISHH-01=Integrated Sensor Programming Remote ²¹
 MA1010-XX=Single Tenon Adapter for 3-1/2" O.D. Tenon
 MA1011-XX=2 @ 180° Tenon Adapter for 3-1/2" O.D. Tenon
 MA1017-XX=Single Tenon Adapter for 2-3/8" O.D. Tenon
 MA1018-XX=2 @ 180° Tenon Adapter for 2-3/8" O.D. Tenon

- NOTES:**
- DesignLights Consortium® Qualified. Refer to www.designlights.org Qualified Products List under Family Models for details.
 - Transformer used only when ordered with motion sensor or AXCS1 through AXCS5 or AXCL6 fixture wattages.
 - Not available in 347 or 480 VAC.
 - Button photocontrol and any motion sensor not offered together.
 - Only available on AXCL6-AXCL12 models.
 - Used with 277, 347, and 480 VAC options.
 - Only available on AXCS1-AXCS5 models.
 - This configuration may contain materials that are not RoHS compliant. Contact your lighting representative for more information.
 - Uses deep back housing.
 - The ISHH-01 accessory is required to adjust parameters.
 - Ambient operating temperature -20°C to 25°C for AXCL6 through AXCL10. Ambient operating temperature -20°C to 30°C on AXCS4 models. Ambient operating temperature -20°C to 40°C on AXCS1 through AXCS3 models.
 - Not available with AXCS5 or AXCL12 models.
 - Uses deep back housing for AXCS1, AXCL2, AXCS3, and AXCS4 models.
 - Not to be mounted in upwards / inverted orientation. Downlight wall mount only for AXCS1 through AXCS4.
 - In AXCS1, AXCS2, AXCS3, and AXCS4 models, CBP cannot be used with any sensor option (PC, MSP, LWR).
 - Can not be ordered with CBP or PC options.
 - Use dedicated IES files on product website for lumen values and distributions.
 - Requires the use of PC1 or PC2 button photocontrol. See After Hours Dim supplemental guide for additional information.
 - Replace XX with color designation.
 - For use with full cutoff lens configurations only.
 - This tool enables adjustment to parameters including high and low modes, sensitivity, time delay, cutoff and more. Consult you lighting representative at Eaton for more information.

STOCK ORDERING INFORMATION

Model Series ¹			
Full Cutoff		Refractive Lens	
AXCS1A=14W	AXCL10A=102W	AXCS1ARL=14W	AXCL10ARL=102W
AXCS2A=21W	AXCL12A=123W	AXCS2ARL=21W	AXCL12ARL=123W
AXCS3A=27W	AXCL6A-347V=56W	AXCS3ARL=27W	AXCL6ARL-347V=56W
AXCS4A=44W	AXCL8A-347V=72W	AXCS4ARL=44W	AXCL8ARL-347V=72W
AXCS5A=52W	AXCL10A-347V=102W	AXCS5ARL=52W	AXCL10ARL-347V=102W
AXCL6A=56W	AXCL12A-347V=123W	AXCL6ARL=56W	AXCL12ARL-347V=123W
AXCL8A=72W		AXCL8ARL=72W	

- NOTES:**
- All stock configurations are 4000K color temperatures, standard Carbon Bronze finish, and wall mount configuration.



Eaton
 1121 Highway 74 South
 Peachtree City, GA 30269
 P: 770-486-4800
 www.eaton.com/lighting

Specifications and
 dimensions subject to
 change without notice.

SP2023-048: Site Plan for McDonald's

Please address the following comments (*M= Mandatory Comments; I = Informational Comments*)

- I.1 This is a request by Leslie Ford of Ofi Chito on behalf of Michael Hampton of Creekside Commons Crossing, LP for the approval of a Site Plan for a Restaurant, Greater than 2,000 SF, with Drive-Through or Drive-In (i.e. McDonald's) on a 1.251-acre tract of land identified as a portion of Lot 3 and all of Lot 2, Block A, Creekside Commons Addition, City of Rockwall, Rockwall County, Texas, zoned Commercial (C) District, situated within the SH-205 Overlay (SH-205 OV) District, generally located north of the northeast corner of the intersection of S. Goliad Street [*SH-205*] and FM-549.
- I.2 For questions or comments concerning this case please contact Henry Lee in the Planning Department at (972) 772-6434 or email hlee@rockwall.com.
- M.3 For reference, include the case number (*SP2023-048*) in the lower right-hand corner of all pages of all revised plan submittals. (*Subsection 01.02(D), Article 11, Unified Development Code [UDC]*)
- M.4 Please remove all proposed signage from the site plan and building elevations. All signage will be covered by a separate permit. (*Subsection 06.02. F, of Article 05, UDC*)
- I.5 The subject property will be required to replat if any lot lines are adjusted, ROW is required, or any new easements are established.
- M.6 Provide the standard signature block with signature space for the Planning and Zoning Chairman and the Planning Director on all pages of the plans. Also remove the red placeholder text from the signature block. (*Subsection 03.04. A, of Article 11, UDC*)

APPROVED:

I hereby certify that the above and foregoing site plan for a development in the City of Rockwall, Texas, was approved by the Planning & Zoning Commission of the City of Rockwall on the ____ day of _____, ____.

WITNESS OUR HANDS, this ____ day of _____, ____.

Planning & Zoning Commission, Chairman

Director of Planning and Zoning

- M.7 Site Plan:
 - (1) Please only indicate the building setbacks adjacent to right-of-way (*Subsection 03.04. B, of Article 11, UDC*)
 - (2) The parking calculation for *Restaurant* is one (1) parking space per 300 SF. In this case, 49 parking spaces are required. Based on the proposed site plan the parking is deficient one (1) space. If not corrected, this will be an Exception.
 - (3) The storage area incorporated into the dumpster enclosure must be incorporated into the primary building. Accessory buildings are not permitted within a Commercial (C) District. Please update the plans to reflect this. (*Subsection 01.05. B, of Article 05, UDC*)
 - (4) Please provide a dumpster detail that addresses the dumpster enclosure requirements, which are as follows. Trash/Recycling enclosures shall be four (4) sided. These receptacles shall be screened by a minimum eight (8) foot, solid masonry dumpster enclosure that utilizes the same masonry materials as the primary building and incorporates an opaque, self-latching gate. The enclosure must have 5-gallon evergreen shrubs planted around it. (*Subsection 01.05. B, of Article 05, UDC*)
 - (5) There shall be no outside storage.
- M.8 Photometric Plan:
 - (1) Please provide cut sheets for all of the proposed lighting fixtures. (*Subsection 03.03, of Article 07, UDC*)
- M.9 Building Elevations:
 - (1) Being in an overlay district and being less than 6,000 SF requires the roof to be pitched. This will be a Variance. (*Subsection 06.02. C.2, of Article 05*)
 - (2) Exterior walls should consist of 90% masonry materials excluding doors and windows. In this case, the building does not incorporate 90% masonry or primary materials on the North, South, and West façades. This will be a Variance. (*Subsection 06.02. C, of Article 05, UDC*)

- (3) At least 20% natural or quarried stone shall be utilized on each façade. In this case, the required stone percentage is deficient on the South and West façades. This will be a Variance. (Subsection 06.02. C, of Article 05, UDC)
- (4) The following primary articulation standards are not in compliance: (1) Projection Height, (2) Wall Projection, and Primary Entry Element Width (i.e. parapet width). This will be a Variance. (Subsection 04.01. C. 1, of Article 05, UDC)

- I.10 Staff has identified the following exception(s) and variance(s) associated with the proposed request: [1] 90% masonry, [2] 20% stone, [3] roof design, and [4] four (4) sided architecture requirements. Should you decide to request these items as variance(s)/exception(s), please provide a letter that lists the variance(s)/exception(s), why they are being requested, and the subsequent compensatory measures. For each variance/exception requested the UDC requires two (2) compensatory measures (Subsection 09.01, of Article 11). Examples of compensatory measures include the increased use of masonry material or stone, increased articulation, increased architectural elements, more pedestrian amenity, larger landscape planting sizes, etc.
- I.11 Please note that failure to address all comments provided by staff by 3:00 PM on January 3, 2024 will result in the automatic denial of the case on the grounds of an incomplete submittal. No refund will be given for cases that are denied due to an incomplete submittal, and a new application and fee will be required to resubmit the case.
- I.12 Staff has identified the aforementioned items necessary to continue the submittal process. Please make these revisions and corrections, and provide any additional information that is requested. Revisions for this case will be due on January 3, 2024; however, it is encouraged for applicants to submit revisions as soon as possible to give staff ample time to review the case prior to the January 9, 2024 Planning & Zoning Meeting.
- I.13 Please note the scheduled meetings for this case:
1) Planning & Zoning Work Session meeting will be held on December 27, 2023.
2) Planning & Zoning meeting/public hearing meeting will be held on January 9, 2024.
- I.14 If the Planning and Zoning Commission approves this site plan case, the applicant will be responsible for submitting hard copies of the final site plan submittal package -- *with all comments addressed* -- for signatures from the Planning and Zoning Commission Chairman and Director of Planning and Zoning. Please note that this will be required to be completed prior to the acceptance of civil engineering plans.
- I.15 All meetings will be held in person and in the City's Council Chambers. All meetings listed above are scheduled to begin at 6:00 p.m. (P&Z). A representative(s) must be present for these meetings. During the upcoming work session meeting with the Planning and Zoning Commission, representative(s) are expected to present their case and answer any questions the Planning Commission may have regarding this request.

ENGINEERING COMMENTS:

1. 6.5 sack mix minimum.
2. Dumpsters will need oil/water separators that outfall to the storm sewer system.
3. Need one-way signage for all one-way drive aisles.
4. Before you can remove this existing detention pond you will need to construct the new one for the overall development.
5. Creekside Commons PH II shows the water meters over located over here.
6. Steel edging must be high enough to contain the mulch.

General Comments:

General Items:

- Must meet City Standards of Design and Construction
- 4% Engineering Inspection Fees
- Impact Fees (Water, Wastewater & Roadway)
- Minimum easement width is 20' for new easements. No structures including walls allowed in easements.
- Retaining walls 3' and over must be engineered.
- All retaining walls 18" and taller must be rock or stone face. No smooth concrete walls.
- Dumpsters may not directly face a public roadway.
- Improvements proposed by 7-11 are currently being installed. As-Builts are not available at this time, only construction plans.

Drainage Items:

- Detention is required. Use the Modified Rational Method for acreages less than 20 acres.

- Temporary detention pond on site must be mitigated and easement abandoned by plat.
- Dumpster areas to drain to oil/water separator and then to the storm lines.
- No vertical walls allowed in detention easement
- No public water or sanitary sewer allowed in detention easement
- There is no underground storm sewer system within SH205 ROW. Drainage must outfall to bar ditch with TxDOT permit. Permit will be submitted to TxDOT by the City. Site drainage must meet approved drainage plan for relocated detention system and drainage improvements (not yet approved).

Water and Wastewater Items:

- Water minimum 8" water line on site.
- Only one "use" off a dead-end line (domestic, irrigation, fire sprinkler, fire hydrant, etc.)
- Minimum public sewer is 8".
- Water and sewer must be 10' apart.
- Sanitary sewer must be extended to property to the northwest.

Roadway Paving Items:

- Parking to be 20'x9' facing the building or nose-to-nose.
- No dead-end parking allowed without an City approved turnaround.
- Drive isles to be 24' wide.
- Fire lane to have 20' min radius if buildings are less than 30' tall. If any of the buildings are 30' or more, the fire lane will be 30' radius minimum.
- Fire lane to be in a platted easement.
- Fire Lane though or turn around maybe required for the north east fire lane.

Landscaping:

- No trees to be with 10' of any public water, sewer or storm line that is 10" in diameter or larger.
- No trees to be with 5' of any public water, sewer, or storm line that is less than 10".

BUILDING INSPECTIONS COMMENTS:

- Oil/water Separator and Grease Trap are to be sized by an Engineer per the 2021 International Plumbing Code and this information will be required to be provided with the Building Permit
- Signage and Irrigation require separate permits from the Building Permit submittal

FIRE DEPARTMENT COMMENTS:

- An automatic sprinkler system shall be provided throughout if the
- the building has an occupant load of 100 or more.

GIS COMMENTS:

- Assigned address will be: 4901 S GOLIAD ST, ROCKWALL, TX 75032

PARKS DEPARTMENT COMMENTS:

- October Glory Maples need to be wrapped on the trunk from the ground to bottom of canopy for the first 1 to 2 years to prevent sun scald on the bark which generally can induce other issue resulting in the death of the tree.

LEGEND	
LIGHT STANDARD (15' CLEAR FROM ALL OVERHEAD UTILITY LINES) (24" CLEAR FROM BACK OF CURB)	
MCDONALD'S DIGITAL MENU BOARD	
MCDONALD'S ORDER HERE CANOPY	
MCDONALD'S DIGITAL PRE-BROWSE BOARD	
MCDONALD'S DOUBLE GATEWAY	
MCDONALD'S DIRECTIONAL SIGN	
DETECTOR LOOP (LOCATION TO BE APPROVED BY MCDONALD'S) (RE: C10.0 STANDARD DETAILS)	
"DRIVE-THRU" WITH "CIRCLE / ARROW" - COLOR : YELLOW	
PAINTED "STOP" AND 12" STOP BAR WITH "STOP" SIGN - COLOR : YELLOW *	
**"THANK YOU" AT END OF PATH - COLOR : YELLOW *	
"CIRCLE / ARROW" - COLOR : YELLOW	
ARROW PATH DIRECTION - COLOR : WHITE	
STRAIGHT DRIVE-THRU "ARROW MARKING" - COLOR : YELLOW	

PAVING LEGEND	
HEAVY DUTY REINFORCED CONCRETE @ DRIVE-THRU & PARKING AREA. MINIMUM 5" THICK WITH #3 BARS @ 18" O.C.E.W. CONCRETE TO BE 3600 PSI 28-DAY STRENGTH	
HEAVY DUTY REINFORCED CONCRETE @ DRIVING AREAS & FIRE LANES. MINIMUM 6" THICK WITH #3 BARS @ 18" O.C.E.W. CONCRETE TO BE 3600 PSI 28-DAY STRENGTH	
REINFORCED CONCRETE PAVEMENT @ TRASH ENCLOSURE APRON. MINIMUM 7" THICK REINFORCED WITH #4 BARS @ 18" O.C.E.W. CONCRETE TO BE 4,000 PSI 28-DAY STRENGTH	

1" SCREED ON TOP OF CURB AT CORNER NEAR NORTHWEST CORNER OF 24" FIRE LANE. ACCESS TO UTILITY EASEMENT. NEAR THE SOUTHWEST LINE OF LOT 4. HORIZONTAL SIDE OF S.N. 205 ELEV.=553.10'

6.5 sack mix minimum.

Dumpsters will need oil/water separators that outfall to the storm sewer system.

Need one-way signage for all one-way drive aisles.

Before you can remove this existing detention pond you will need to construct the new one for the overall development.

- General Items:**
- Must meet City Standards of Design and Construction
 - 4% Engineering Inspection Fees
 - Impact Fees (Water, Wastewater & Roadway)
 - Minimum easement width is 20' for new easements. No structures including walls allowed in easements.
 - Retaining walls 3' and over must be engineered.
 - All retaining walls 18" and taller must be rock or stone face. No smooth concrete walls.
 - Dumpsters may not directly face a public roadway.
 - Improvements proposed by 7-11 are currently being installed. As-Builts are not available at this time, only construction plans.

- Drainage Items:**
- Detention is required. Use the Modified Rational Method for acreages less than 20 acres.
 - Temporary detention pond on site must be mitigated and easement abandoned by plat.
 - Dumpster areas to drain to oil/water separator and then to the storm lines.
 - No vertical walls allowed in detention easement
 - No public water or sanitary sewer allowed in detention easement
 - There is no underground storm sewer system within SH205 ROW. Drainage must outfall to bar ditch with TxDOT permit. Permit will be submitted to TxDOT by the City. Site drainage must meet approved drainage plan for relocated detention system and drainage improvements (not yet approved).

- Water and Wastewater Items:**
- Water minimum 8" water line on site.
 - Only one "use" off a dead-end line (domestic, irrigation, fire sprinkler, fire hydrant, etc.)
 - Minimum public sewer is 8".
 - Water and sewer must be 10' apart.
 - Sanitary sewer must be extended to property to the northwest.

- Roadway Paving Items:**
- Parking to be 20'x9' facing the building or nose-to-nose.
 - No dead-end parking allowed without an City approved turnaround.
 - Drive isles to be 24' wide.
 - Fire lane to have 20' min radius if buildings are less than 30' tall. If any of the buildings are 30' or more, the fire lane will be 30' radius minimum.
 - Fire lane to be in a platted easement.
 - Fire Lane though or turn around maybe required for the north east fire lane.

- Landscaping:**
- No trees to be with 10' of any public water, sewer or storm line that is 10" in diameter or larger.
 - No trees to be with 5' of any public water, sewer, or storm line that is less than 10".

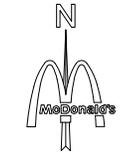
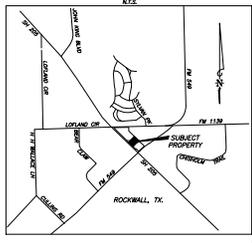
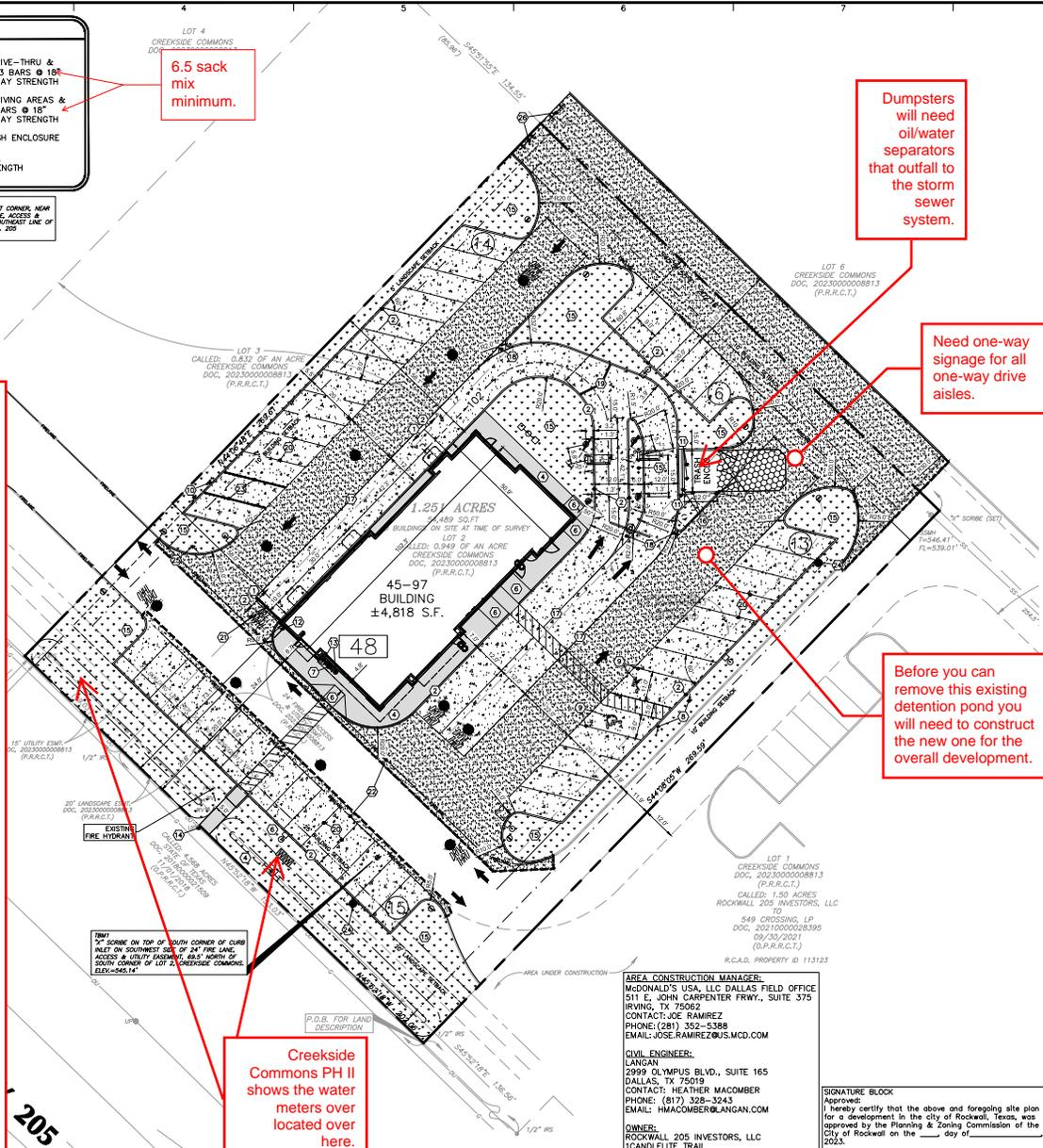

SCALE: 1" = 20'

Date	Description	No.
Revisions		

McDonald's USA, LLC

These drawings and specifications are the confidential and proprietary property of McDonald's USA, LLC and shall not be copied or reproduced without written authorization. The contract documents were prepared for use on this specific site in conjunction with its lease sale and are not suitable for use on a different site or at a later time. Use of these drawings for reference or example on another project requires the services of properly licensed architects and engineers. Reproduction of the contract documents for reuse on another project is not authorized.



LANGAN

Langan Engineering and Environmental Services, Inc.
2989 Olympus Blvd, Suite 165
Dallas, TX 75019
T: 817.328.3200 www.langan.com
TYPE FIRM REG. #F-13709

Project
McDonald's Restaurant L/C #042-3426 (NSN 41096) NWC S.H. 205 & FM 549 PROPOSED LOT 2, BLOCK A, CREEKSIDE COMMONS

ROCKWALL COUNTY TEXAS

Drawing Title
SITE PLAN

Project No. 520061401	Drawing No. C4.0
Date 12/13/2023	Sheet 6 of 21
Drawn By MNK	
Checked By HJM	

AREA CONSTRUCTION MANAGER:
MCDONALD'S USA, LLC DALLAS FIELD OFFICE
511 E JOHN CARPENTER FRWY., SUITE 375
IRVING, TX 75062
CONTACT: JOE RAMIREZ
PHONE: (281) 352-5368
EMAIL: JOSE.RAMIREZ@US.MCD.COM

CIVIL ENGINEER:
LANGAN
2989 OLYMPUS BLVD., SUITE 165
DALLAS, TX 75019
CONTACT: HEATHER MACOMBER
PHONE: (817) 328-3243
EMAIL: HMCOMBER@LANGAN.COM

OWNER:
ROCKWALL 205 INVESTORS, LLC
1 CHANDLER TRAIL
HEATH, TX 75032
CONTACT: JUSTIN WEBB
PHONE: (469) 446-7734
EMAIL: JUSTINW@LATURAHOMES.COM

APPLICANT:
OF CHITO
3224 COLLINSWORTH STREET
FORT WORTH, TX 76107
CONTACT: LESLIE FORD
PHONE: (817) 370-0965
EMAIL: LESLIE@OFCHITO.COM

WITNESS OUR HANDS, THIS ____ day of _____ 2023.

Planning & Zoning Commission, Chairman

Director of Planning and Zoning

CASE NUMBER: SP2023-035

Know what's below.
Call before you dig.

LANDSCAPE ORDINANCE COMPLIANCE CHART

ORDINANCE SECTION	DESCRIPTION	REQUIRED/PROVIDED	COMPLIANCE
Section 5.01	Minimum of 20' wide landscape buffer along all State Highway 205 All landscape buffers adjacent to a public right-of-way shall incorporate ground cover, a built-up 30" tall berm and minimum 30" tall shrubby along the entire length of the frontage. Also a minimum of one (2) canopy tree and one (4) accent tree shall be incorporated into the landscape buffer per 100-linear feet of frontage along the State Highway 205	REQUIRED: 20' wide buffer PROVIDED: 20' wide buffer	COMPLIES
		REQUIRED: 30" tall berm, 30" tall shrubs, and groundcover along entire length of frontage PROVIDED: 30" tall berm, 30" tall shrubs, and groundcover along entire length of frontage	COMPLIES
Section 5.03	Minimum 20% of the total site must be landscaped Minimum 5% or 200 Sq.Ft of Landscaping whichever is greater in the interior parking lot area. And must have a tree within 80' of each required parking space. Minimum of 50% of required landscape must be located in the front yard or side yards of the site.	REQUIRED: 54.489 Sq Ft x 0.2 = 10.897 8 Sq Ft PROPOSED: 11.489 Sq Ft (21.1%)	COMPLIES
		REQUIRED: 4.466 Sq Ft (Proposed parking area) x 0.05 = 423.3 Sq Ft of Landscaping required PROPOSED: 1.580 Sq Ft (18.6%) and every parking space has a tree within 80' of it REQUIRED: 10.897 8 Sq Ft x 0.5 = 5.448 9 Sq Ft PROPOSED: 6.453 Sq Ft (77.5%)	COMPLIES

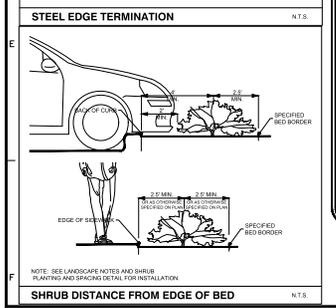
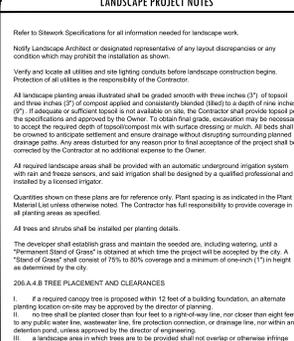
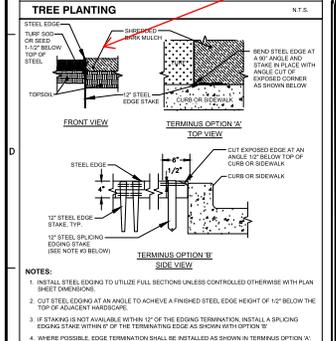
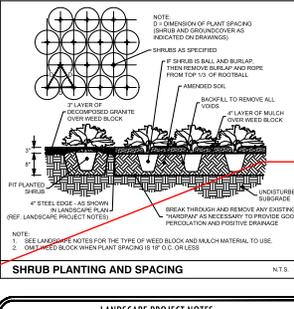
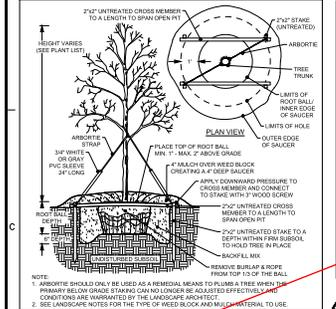

PLANT SCHEDULE

TREES	KEY	QTY	BOTANICAL / COMMON NAME	SIZE	ROOT	HEIGHT/WIDTH	SPACING
ACER	AO	9	ACER RUBRUM 'OCTOBER GLORY' / OCTOBER GLORY RED MAPLE	4" CAL	B&B	14'-16" H 7'-8" W	
CERIS	OC	11	CERIS CANADENSIS / TEXAS REDBUD	2" CAL	B&B	8'-10" H 4'-5" W	25' O.C.
ELM	UC	4	ULMUS CRASSIFOLIA / CEDAR ELM	4" CAL	B&B	14'-16" H 7'-8" W	50' O.C.
SHRUBS	IB	8	ILEX CORNUTA 'BURFORDI NANA' / DWARF BURFORD HOLLY	5 GAL	CONTAINER	2'-4" H 2'-4" W	4' O.C.
	RI	102	RHAPHOLEPIS INDICA / INDIAN HAWTHORN	5 GAL	CONTAINER	2'-4" H 2'-4" W	4' O.C.
GROUND COVERS	IB	30	LIROPE MUSCARI 'BIG BLUE' / BIG BLUE LILYTURF	1 GAL	CONTAINER	6'-18" H 6'-12" W	24" O.C.
	LH	326	LANTANA X 'NEW GOLD' / NEW GOLD LANTANA	1 GAL	CONTAINER	6'-12" H 6'-10" W	24" O.C.

NOTE:
1) WRAP TRUNKS OF MAPLE SPECIES FOR 1ST YEAR TO PREVENT BARK SUN SCALD AND EVENTUAL LOSS OF TREES.

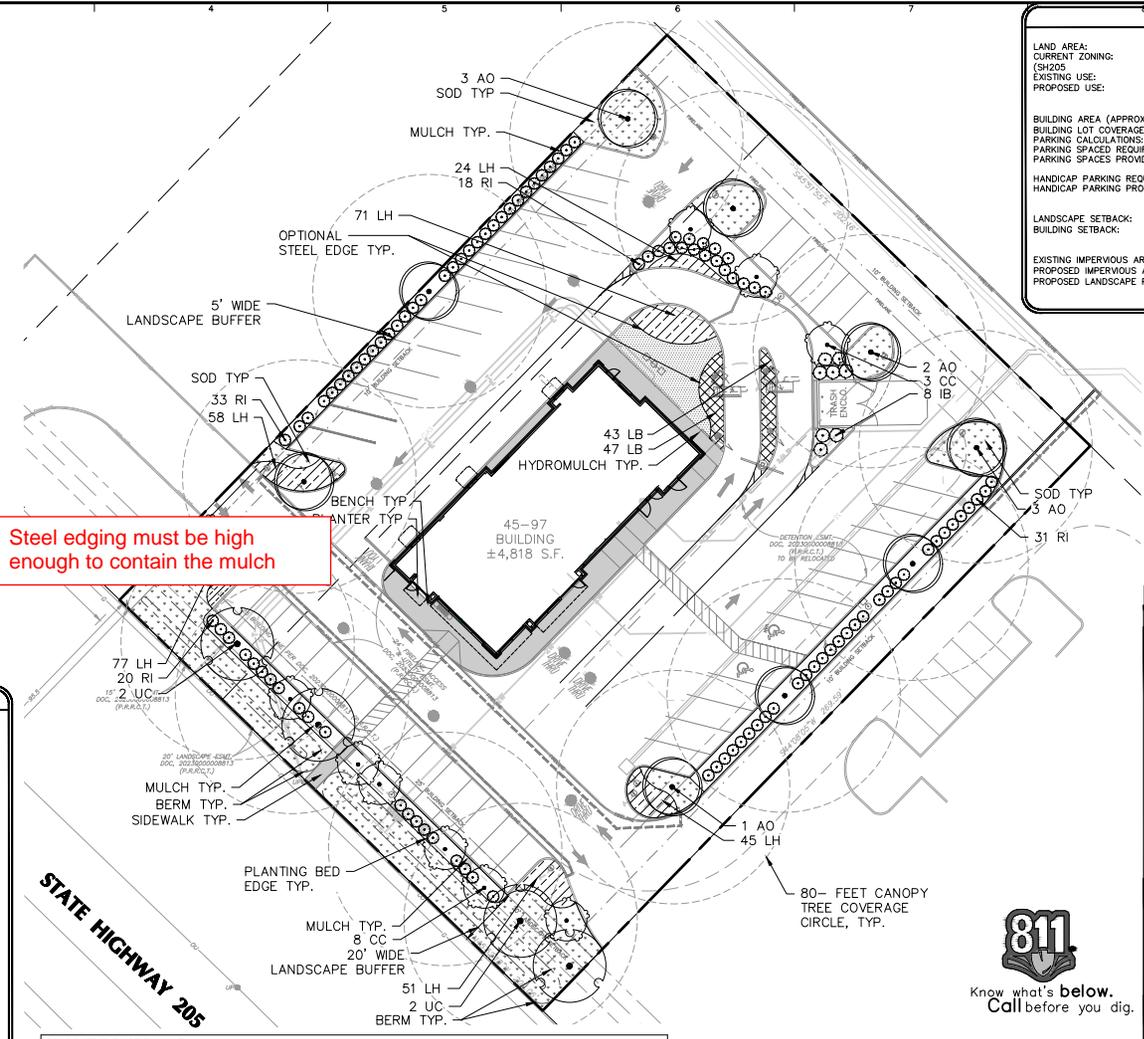

Steel edging must be high enough to contain the mulch

SITE INFORMATION

LAND AREA:	54,489 SF (1.251 AC)
CURRENT ZONING:	C-COMMERCIAL DISTRICT
EXISTING USE:	OVERLAY DISTRICT
PROPOSED USE:	VACANT LOT
BUILDING AREA (APPROXIMATE):	4,818 GFA
BUILDING LOT COVERAGE:	4,818 SF / 54,489 SF = 8.84%
PARKING CALCULATIONS:	1 SPACE PER 100 SF
PARKING SPACES REQUIRED:	48
PARKING SPACES PROVIDED:	48
HANDICAP PARKING REQUIRED:	2
HANDICAP PARKING PROVIDED:	2
LANDSCAPE SETBACK:	20' FRONT; 5' REAR & SIDE
BUILDING SETBACK:	25' FRONT; 10' SIDES & REAR
EXISTING IMPERVIOUS AREAS:	13.9% (7,592 SF)
PROPOSED IMPERVIOUS AREAS:	65.8% (35,848 SF)
PROPOSED LANDSCAPE PERCENTAGE:	20.3% (11,049 SF)

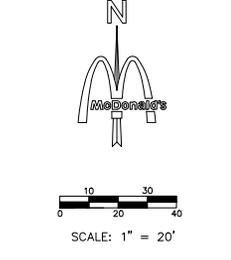

McDonald's USA, LLC

These drawings and specifications are the confidential and proprietary property of McDonald's USA, LLC and shall not be copied or reproduced without written authorization. The contract documents have been prepared for use on this specific site in conjunction with its lease sale and are not suitable for use on a different site or at a later time. Use of these drawings for reference or example on another project requires the services of properly licensed architects and engineers. Reproduction of the contract documents for reuse on another project is not authorized.

Date	Description	No.
Revisions		

LANGAN

Langan Engineering and Environmental Services, Inc.
2980 Olympus Blvd., Suite 165
Dallas, TX 75219
T: 817.328.3200 TBEI FIRM REG. #F-13709 www.langan.com

McDonald's Restaurant
C #042-3426 (NSN 41096)
NWC S.H. 205 & FM 549
PROPOSED LOT 2R, BLOCK A,
CREEKSIDE COMMONS
ROCKWALL
DALLAS COUNTY TEXAS

LANDSCAPE PLAN

Project No. 520061401
Date 12/13/2023
Drawing No. L1.0
Sheet 21 of 21

SIGNATURE BLOCK
Approved: I hereby certify that the above and foregoing site plan for a development in the city of Rockwall, Texas, was approved by the planning & zoning commission of the City of Rockwall on the ___ day of _____, 2023.
WITNESS OUR HANDS, this ___ day of _____, 2023.
Planning & Zoning Commission, Chairman
Director of Planning and Zoning



DEVELOPMENT APPLICATION

City of Rockwall
Planning and Zoning Department
385 S. Goliad Street
Rockwall, Texas 75087

STAFF USE ONLY

PLANNING & ZONING CASE NO. _____

NOTE: THE APPLICATION IS NOT CONSIDERED ACCEPTED BY THE CITY UNTIL THE PLANNING DIRECTOR AND CITY ENGINEER HAVE SIGNED BELOW.

DIRECTOR OF PLANNING: _____

CITY ENGINEER: _____

PLEASE CHECK THE APPROPRIATE BOX BELOW TO INDICATE THE TYPE OF DEVELOPMENT REQUEST [SELECT ONLY ONE BOX]:

PLATTING APPLICATION FEES:

- MASTER PLAT (\$100.00 + \$15.00 ACRE) ¹
- PRELIMINARY PLAT (\$200.00 + \$15.00 ACRE) ¹
- FINAL PLAT (\$300.00 + \$20.00 ACRE) ¹
- REPLAT (\$300.00 + \$20.00 ACRE) ¹
- AMENDING OR MINOR PLAT (\$150.00)
- PLAT REINSTATEMENT REQUEST (\$100.00)

SITE PLAN APPLICATION FEES:

- SITE PLAN (\$250.00 + \$20.00 ACRE) ¹
- AMENDED SITE PLAN/ELEVATIONS/LANDSCAPING PLAN (\$100.00)

ZONING APPLICATION FEES:

- ZONING CHANGE (\$200.00 + \$15.00 ACRE) ¹
- SPECIFIC USE PERMIT (\$200.00 + \$15.00 ACRE) ^{1&2}
- PD DEVELOPMENT PLANS (\$200.00 + \$15.00 ACRE) ¹

OTHER APPLICATION FEES:

- TREE REMOVAL (\$75.00)
- VARIANCE REQUEST/SPECIAL EXCEPTIONS (\$100.00) ²

NOTES:

¹: IN DETERMINING THE FEE, PLEASE USE THE EXACT ACREAGE WHEN MULTIPLYING BY THE PER ACRE AMOUNT. FOR REQUESTS ON LESS THAN ONE ACRE, ROUND UP TO ONE (1) ACRE.
²: A \$1,000.00 FEE WILL BE ADDED TO THE APPLICATION FEE FOR ANY REQUEST THAT INVOLVES CONSTRUCTION WITHOUT OR NOT IN COMPLIANCE TO AN APPROVED BUILDING PERMIT.

PROPERTY INFORMATION [PLEASE PRINT]

ADDRESS To Be Assigned

SUBDIVISION Creekside Commons

LOT

BLOCK

A

GENERAL LOCATION NWC of State Hwy 205 FM 549

ZONING, SITE PLAN AND PLATTING INFORMATION [PLEASE PRINT]

CURRENT ZONING C - Commercial District in SH205 Overlay District

CURRENT USE Vacant

PROPOSED ZONING No change to base zoning designation requested.

PROPOSED USE McDonald's Restaurant with Drive-Through

ACREAGE

LOTS [CURRENT]

1

LOTS [PROPOSED]

1

SITE PLANS AND PLATS: BY CHECKING THIS BOX YOU ACKNOWLEDGE THAT DUE TO THE PASSAGE OF HB3167 THE CITY NO LONGER HAS FLEXIBILITY WITH REGARD TO ITS APPROVAL PROCESS, AND FAILURE TO ADDRESS ANY OF STAFF'S COMMENTS BY THE DATE PROVIDED ON THE DEVELOPMENT CALENDAR WILL RESULT IN THE DENIAL OF YOUR CASE.

OWNER/APPLICANT/AGENT INFORMATION [PLEASE PRINT/CHECK THE PRIMARY CONTACT/ORIGINAL SIGNATURES ARE REQUIRED]

OWNER Creekside Commons Crossing, LP

APPLICANT Ofi Chito

CONTACT PERSON Michael Hampton, Vice President

CONTACT PERSON Leslie Ford

ADDRESS 10755 Sandhill Road

ADDRESS 3224 Collinsworth Street

CITY, STATE & ZIP Dallas, Texas 75238

CITY, STATE & ZIP Fort Worth, TX 76107

PHONE 214-271-4630

PHONE 325-370-9965

E-MAIL mhampton@prudentdevelopment.com

E-MAIL leslie@ofichito.com

NOTARY VERIFICATION [REQUIRED]

BEFORE ME, THE UNDERSIGNED AUTHORITY, ON THIS DAY PERSONALLY APPEARED Michael Hampton [OWNER] THE UNDERSIGNED, WHO STATED THE INFORMATION ON THIS APPLICATION TO BE TRUE AND CERTIFIED THE FOLLOWING:

"I HEREBY CERTIFY THAT I AM THE OWNER FOR THE PURPOSE OF THIS APPLICATION; ALL INFORMATION SUBMITTED HEREIN IS TRUE AND CORRECT; AND THE APPLICATION FEE OF \$270.00 TO COVER THE COST OF THIS APPLICATION, HAS BEEN PAID TO THE CITY OF ROCKWALL ON THIS THE 10th DAY OF October, 2023 BY SIGNING THIS APPLICATION, I AGREE THAT THE CITY OF ROCKWALL (I.E. "CITY") IS AUTHORIZED AND PERMITTED TO PROVIDE INFORMATION CONTAINED WITHIN THIS APPLICATION TO THE PUBLIC. THE CITY IS ALSO AUTHORIZED AND PERMITTED TO REPRODUCE ANY COPYRIGHTED INFORMATION SUBMITTED IN CONJUNCTION WITH THIS APPLICATION, IF SUCH REPRODUCTION IS ASSOCIATED OR IN RESPONSE TO A REQUEST FOR PUBLIC INFORMATION."

GIVEN UNDER MY HAND AND SEAL OF OFFICE ON THIS THE 10th DAY OF October, 2023

OWNER'S SIGNATURE

NOTARY PUBLIC IN AND FOR THE STATE OF TEXAS

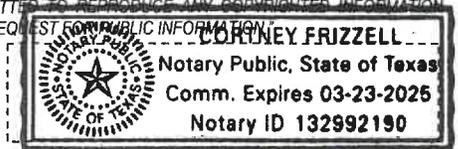

MY COMMISSION EXPIRES 03-23-2025



DEVELOPMENT APPLICATION

City of Rockwall
Planning and Zoning Department
385 S. Goliad Street
Rockwall, Texas 75087

STAFF USE ONLY

PLANNING & ZONING CASE NO. _____

NOTE: THE APPLICATION IS NOT CONSIDERED ACCEPTED BY THE CITY UNTIL THE PLANNING DIRECTOR AND CITY ENGINEER HAVE SIGNED BELOW.

DIRECTOR OF PLANNING: _____

CITY ENGINEER: _____

PLEASE CHECK THE APPROPRIATE BOX BELOW TO INDICATE THE TYPE OF DEVELOPMENT REQUEST [SELECT ONLY ONE BOX]:

PLATTING APPLICATION FEES:

- MASTER PLAT (\$100.00 + \$15.00 ACRE) ¹
- PRELIMINARY PLAT (\$200.00 + \$15.00 ACRE) ¹
- FINAL PLAT (\$300.00 + \$20.00 ACRE) ¹
- REPLAT (\$300.00 + \$20.00 ACRE) ¹
- AMENDING OR MINOR PLAT (\$150.00)
- PLAT REINSTATEMENT REQUEST (\$100.00)

SITE PLAN APPLICATION FEES:

- SITE PLAN (\$250.00 + \$20.00 ACRE) ¹
- AMENDED SITE PLAN/ELEVATIONS/LANDSCAPING PLAN (\$100.00)

ZONING APPLICATION FEES:

- ZONING CHANGE (\$200.00 + \$15.00 ACRE) ¹
- SPECIFIC USE PERMIT (\$200.00 + \$15.00 ACRE) ^{1&2}
- PD DEVELOPMENT PLANS (\$200.00 + \$15.00 ACRE) ¹

OTHER APPLICATION FEES:

- TREE REMOVAL (\$75.00)
- VARIANCE REQUEST/SPECIAL EXCEPTIONS (\$100.00) ²

NOTES:

¹: IN DETERMINING THE FEE, PLEASE USE THE EXACT ACREAGE WHEN MULTIPLYING BY THE PER ACRE AMOUNT. FOR REQUESTS ON LESS THAN ONE ACRE, ROUND UP TO ONE (1) ACRE.

²: A \$1,000.00 FEE WILL BE ADDED TO THE APPLICATION FEE FOR ANY REQUEST THAT INVOLVES CONSTRUCTION WITHOUT OR NOT IN COMPLIANCE TO AN APPROVED BUILDING PERMIT.

PROPERTY INFORMATION [PLEASE PRINT]

ADDRESS	To Be Assigned			
SUBDIVISION	Creekside Commons	LOT	BLOCK	A
GENERAL LOCATION	NWC of State Hwy 205 FM 549			

ZONING, SITE PLAN AND PLATTING INFORMATION [PLEASE PRINT]

CURRENT ZONING	C - Commercial District in SH205 Overlay District	CURRENT USE	Vacant	
PROPOSED ZONING	No change to base zoning designation requested.	PROPOSED USE	McDonald's Restaurant with Drive-Through	
ACREAGE	LOTS [CURRENT]	1	LOTS [PROPOSED]	1

SITE PLANS AND PLATS: BY CHECKING THIS BOX YOU ACKNOWLEDGE THAT DUE TO THE PASSAGE OF HB3167 THE CITY NO LONGER HAS FLEXIBILITY WITH REGARD TO ITS APPROVAL PROCESS, AND FAILURE TO ADDRESS ANY OF STAFF'S COMMENTS BY THE DATE PROVIDED ON THE DEVELOPMENT CALENDAR WILL RESULT IN THE DENIAL OF YOUR CASE.

OWNER/APPLICANT/AGENT INFORMATION [PLEASE PRINT/CHECK THE PRIMARY CONTACT/ORIGINAL SIGNATURES ARE REQUIRED]

<input checked="" type="checkbox"/> OWNER	Creekside Commons Crossing, LP	<input type="checkbox"/> APPLICANT	Ofi Chito
CONTACT PERSON	Michael Hampton, Vice President	CONTACT PERSON	Leslie Ford
ADDRESS	10755 Sandhill Road	ADDRESS	3224 Collinsworth Street
CITY, STATE & ZIP	Dallas, Texas 75238	CITY, STATE & ZIP	Fort Worth, TX 76107
PHONE	214-271-4630	PHONE	325-370-9965
E-MAIL	mhampton@prudentdevelopment.com	E-MAIL	leslie@ofichito.com

NOTARY VERIFICATION [REQUIRED]

BEFORE ME, THE UNDERSIGNED AUTHORITY, ON THIS DAY PERSONALLY APPEARED Michael Hampton [OWNER] THE UNDERSIGNED, WHO STATED THE INFORMATION ON THIS APPLICATION TO BE TRUE AND CERTIFIED THE FOLLOWING:

"I HEREBY CERTIFY THAT I AM THE OWNER FOR THE PURPOSE OF THIS APPLICATION; ALL INFORMATION SUBMITTED HEREIN IS TRUE AND CORRECT, AND THE APPLICATION FEE OF \$ 100.00 TO COVER THE COST OF THIS APPLICATION, HAS BEEN PAID TO THE CITY OF ROCKWALL ON THIS THE 10th DAY OF October, 2023. BY SIGNING THIS APPLICATION, I AGREE THAT THE CITY OF ROCKWALL (I.E. "CITY") IS AUTHORIZED AND PERMITTED TO PROVIDE INFORMATION CONTAINED WITHIN THIS APPLICATION TO THE PUBLIC. THE CITY IS ALSO AUTHORIZED AND PERMITTED TO REPRODUCE AND COPYRIGHTED INFORMATION SUBMITTED IN CONJUNCTION WITH THIS APPLICATION, IF SUCH REPRODUCTION IS ASSOCIATED OR IN RESPONSE TO A REQUEST FOR PUBLIC INFORMATION."

GIVEN UNDER MY HAND AND SEAL OF OFFICE ON THIS THE 10th DAY OF October, 2023.

OWNER'S SIGNATURE [Signature]

NOTARY PUBLIC IN AND FOR THE STATE OF TEXAS [Signature]

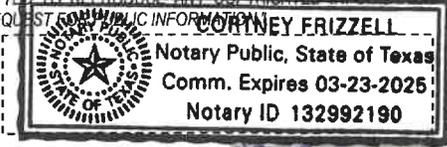

MY COMMISSION EXPIRES 03-23-2025



SP2023-048: Site Plan for a Restaurant with a Drive-Through

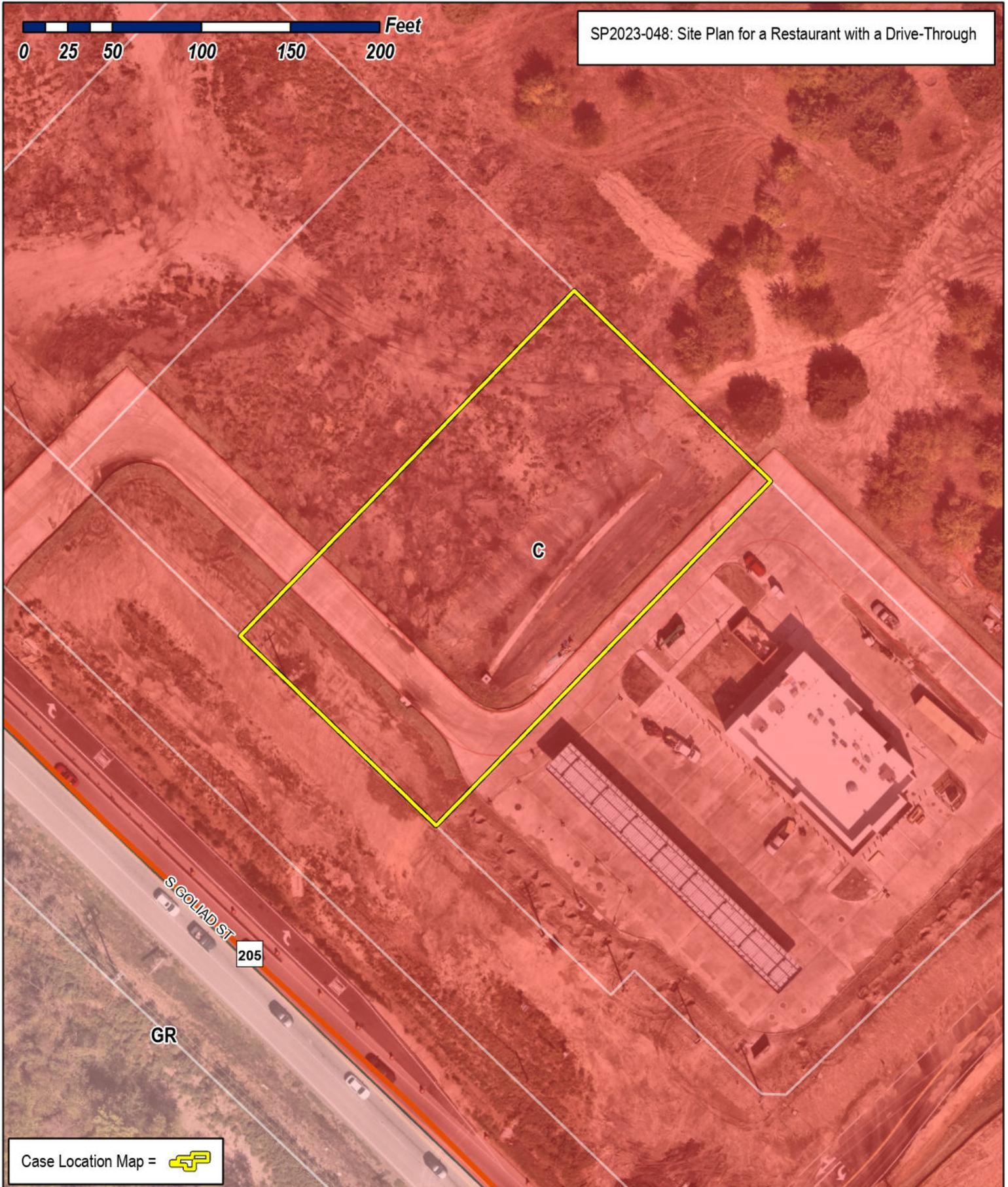

Case Location Map = 



City of Rockwall

Planning & Zoning Department
385 S. Goliad Street
Rockwall, Texas 75087
(P): (972) 771-7745
(W): www.rockwall.com

The City of Rockwall GIS maps are continually under development and therefore subject to change without notice. While we endeavor to provide timely and accurate information, we make no guarantees. The City of Rockwall makes no warranty, express or implied, including warranties of merchantability and fitness for a particular purpose. Use of the information is the sole responsibility of the user.



LEGEND

LIGHT STANDARD (15' CLEAR FROM ALL OVERHEAD UTILITY LINES) (24" CLEAR FROM BACK OF CURB)

McDONALD'S DIGITAL MENU BOARD

McDONALD'S ORDER HERE CANOPY

McDONALD'S DIGITAL PRE-BROWSE BOARD

McDONALD'S DOUBLE GATEWAY

McDONALD'S DIRECTIONAL SIGN

DETECTOR LOOP (LOCATION TO BE APPROVED BY McDONALD'S) (RE: C10.0 STANDARD DETAILS)

"DRIVE-THRU" WITH "CIRCLE / ARROW" - COLOR : YELLOW

PAINTED "STOP" AND 12" STOP BAR WITH "STOP" SIGN - COLOR : YELLOW *

"THANK YOU" AT END OF PATH - COLOR : YELLOW

"CIRCLE / ARROW" - COLOR : YELLOW

ARROW PATH DIRECTION - COLOR : WHITE

STRAIGHT DRIVE-THRU "ARROW MARKING" - COLOR: YELLOW

PAVING LEGEND

HEAVY DUTY REINFORCED CONCRETE @ DRIVE-THRU & PARKING AREA. MINIMUM 5" THICK WITH #3 BARS @ 18" O.C.E.W. CONCRETE TO BE 3600 PSI 28-DAY STRENGTH

HEAVY DUTY REINFORCED CONCRETE @ DRIVING AREAS & FIRE LANES. MINIMUM 6" THICK WITH #3 BARS @ 18" O.C.E.W. CONCRETE TO BE 3600 PSI 28-DAY STRENGTH

REINFORCED CONCRETE PAVEMENT @ TRASH ENCLOSURE APRON. MINIMUM 7" THICK REINFORCED WITH #4 BARS @ 18" O.C.E.W. CONCRETE TO BE 4,000 PSI 28-DAY STRENGTH

KEY NOTE LEGEND

MARK	MARK DESCRIPTION
1	CONCRETE VERTICAL CURB @DRIVE-THRU (RE: C10.2 STANDARD DETAILS)
2	CURB AND GUTTER @NON DRIVE-THRU AREAS (RE: C10.2 STANDARD DETAILS)
3	TURN DOWN CURB (RE: C10.3 STANDARD DETAILS)
4	REINFORCED CONCRETE SIDEWALK (RE: C10.3 STANDARD DETAILS)
5	NOT USED
6	H.C. ACCESS RAMP @1:12 MAX SLOPE (RE: C10.1 STANDARD DETAILS)
7	BENCH (G.C. TO COORDINATE WITH O/O & ACM)
8	HANDICAP ACCESSIBLE SIGN (POLE MOUNTED) (RE: C10.1 STANDARD DETAILS)
9	HANDICAP ACCESSIBLE SPACES / SYMBOLS / CROSSWALK - COLOR : (RE: C10.1 STANDARD DETAILS)
10	McDONALD'S OOSP, MOBILE & ROLL FORWARD SIGNS (RE: C10.4 STANDARD DETAILS)
11	BOLLARD (RE: C10.0 STANDARD DETAILS)
12	5' GUARDRAIL @ INGRESS/EGRESS DOOR (RE: C10.1 STANDARD DETAILS)
13	PLANTERS (G.C. TO COORDINATE WITH O/O & ACM)
14	POLE MOUNTED TRANSFORMER (RE: C9.0 UTILITY PLAN)
15	LANDSCAPE FINISH GRADE 1" BELOW TOP OF CURB IN ALL LAWN AREAS AND 2" BELOW TOP OF CURB IN ALL BED AREAS
16	8' TALL MASONRY SCREENING WALL (RE: ARCHITECTURAL PLANS)
17	6" DRIVE-THRU STRIPING - COLOR : YELLOW
18	4" DIAGONAL PAINTED ISLANDS AT DRIVE-THRU - COLOR : YELLOW
19	6" MERGE POINT - COLOR : YELLOW
20	4" PARKING STALL STRIPING - COLOR : WHITE (TYP)
21	8" OOSP STRIPING - COLOR : YELLOW
22	FIRE LANE STRIPING PER CITY OF ROCKWALL FIRE CODE STANDARDS
23	4" OOSP & MOBILE PICK-UP STRIPING - COLOR : YELLOW
24	DRAINAGE STRUCTURE (RE: C8.1 POST DEVELOPED DRAINAGE PLAN)
25	DO NOT ENTER SIGN
26	TYPE III BARRICADE (PER MUTCD STANDARDS)

SITE INFORMATION

LAND AREA:	54,489 SF (1.251 AC)
CURRENT ZONING:	C-COMMERCIAL DISTRICT (SH205 OVERLAY DISTRICT)
EXISTING USE:	VACANT LOT
PROPOSED USE:	McDONALD'S RESTAURANT W/DRIVE-THRU
BUILDING AREA (APPROXIMATE):	4,818 GFA
BUILDING LOT COVERAGE:	4,818 SF/54,489 SF = 8.84%
PARKING CALCULATIONS:	1 SPACE PER 100 SF
PARKING SPACED REQUIRED:	48
PARKING SPACES PROVIDED:	48
HANDICAP PARKING REQUIRED:	2
HANDICAP PARKING PROVIDED:	2
LANDSCAPE SETBACK:	20' FRONT; 5' REAR & SIDE
BUILDING SETBACK:	25' FRONT; 10' SIDES & REAR
EXISTING IMPERVIOUS AREAS:	13.9% (7,592 SF)
PROPOSED IMPERVIOUS AREAS:	65.8% (35,848 SF)
PROPOSED LANDSCAPE PERCENTAGE:	20.3% (11,049 SF)

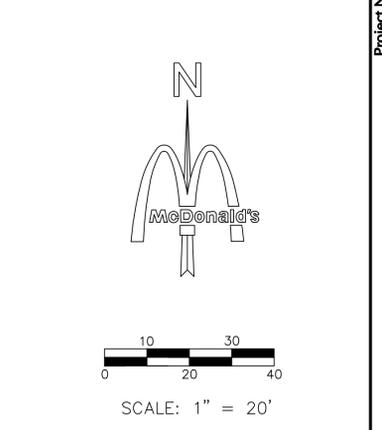
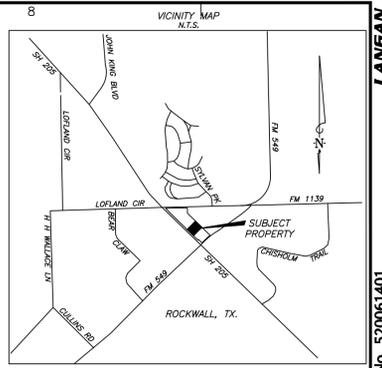
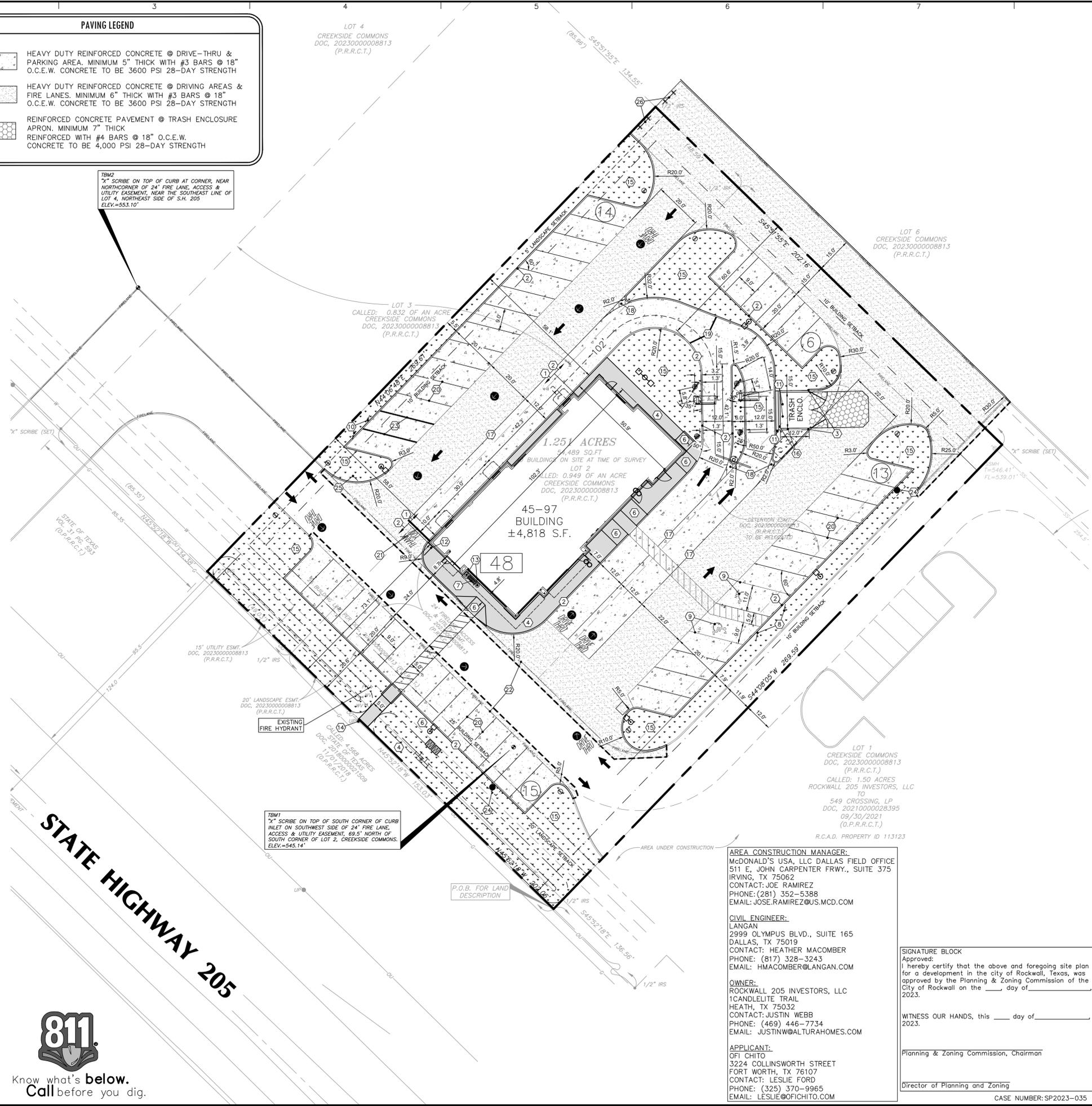

Date	Description	No.
Revisions		

McDonald's USA, LLC

These drawings and specifications are the confidential and proprietary property of McDonald's USA, LLC and shall not be copied or reproduced without written authorization. The contract documents were prepared for use on this specific site in conjunction with its issue date and are not suitable for use on a different site or at a later time. Use of these drawings for reference or example on another project requires the services of properly licensed architects and engineers. Reproduction of the contract documents for reuse on another project is not authorized.

12.14.23

LANGAN

Langan Engineering and Environmental Services, Inc.

2999 Olympus Blvd, Suite 165
Dallas, TX 75019

T: 817.328.3200 www.langan.com
TBPE FIRM REG. #F-1709

Project **McDonald's Restaurant L/C #042-3426 (NSN 41096) NWC S.H. 205 & FM 549 PROPOSED LOT 2R, BLOCK A, CREEKSIDE COMMONS ROCKWALL**

ROCKWALL COUNTY TEXAS
Drawing Title

SITE PLAN

Project No.	520061401	Drawing No.	C4.0
Date	12/13/2023	Drawn By	
Checked By	HJM	Director of Planning and Zoning	Sheet 6 of 21

AREA CONSTRUCTION MANAGER:
McDONALD'S USA, LLC DALLAS FIELD OFFICE
511 E. JOHN CARPENTER FRWY., SUITE 375
IRVING, TX 75062
CONTACT: JOE RAMIREZ
PHONE: (281) 352-5388
EMAIL: JOSE.RAMIREZ@US.MCD.COM

CIVIL ENGINEER:
LANGAN
2999 OLYMPUS BLVD., SUITE 165
DALLAS, TX 75019
CONTACT: HEATHER MACOMBER
PHONE: (817) 328-3243
EMAIL: HMACOMBER@LANGAN.COM

OWNER:
ROCKWALL 205 INVESTORS, LLC
1 CANDLELITE TRAIL
HEATH, TX 75032
CONTACT: JUSTIN WEBB
PHONE: (469) 446-7734
EMAIL: JUSTINW@ALTURAHOMES.COM

APPLICANT:
OFI CHITO
3224 COLLINSWORTH STREET
FORT WORTH, TX 76107
CONTACT: LESLIE FORD
PHONE: (325) 370-9965
EMAIL: LESLIE@OFICHITO.COM

SIGNATURE BLOCK
Approved: _____
I hereby certify that the above and foregoing site plan for a development in the city of Rockwall, Texas, was approved by the Planning & Zoning Commission of the City of Rockwall on the ____ day of _____, 2023.

WITNESS OUR HANDS, this ____ day of _____, 2023.

Planning & Zoning Commission, Chairman

Director of Planning and Zoning

BUILDING MATERIAL CALCULATIONS BUILDING											
Materials	South Elevation		East Elevation		West Elevation		North Elevation		Totals		Total Masonry
	SF	%	SF	%	SF	%	SF	%	SF	%	
Brick	511	61.71%	1,234	61.79%	1,559	70.16%	376	32.14%	3,680	59.19%	87.71%
Limestone	71	8.57%	554	27.74%	303	13.64%	540	46.15%	1,468	23.61%	
Stucco	50	6.04%	103	5.16%	102	4.59%	50	4.27%	305	4.91%	
Wood Look Battens	196	23.67%	106	5.31%	106	4.77%	204	17.44%	612	9.84%	
Metal Paneling	0	0.00%	0	0.00%	152	6.84%	0	0.00%	152	2.44%	
Totals (Excluding Glazing)	828	100%	1,997	100%	2,222	100%	1,170	100%	6,217	100%	

B1 - BRICK "MUSHROOM BROWN" LL - LIMESTONE "LINEN" B2 - BRICK "EBONY"



CN - ALUM CANOPY WHITE UN - UNDERSCORE YELLOW E - STUCCO "IRON SPOT" AL - WOOD LOOK BATTENS AP - APOLIC METAL PANELS

- T/BLK'G @ PARAPET ELEV. + 23'-7 1/2"
- T/BATTENS ELEV. + 22'-3"
- B/CANOPY ELEV. + 10'-11"
- B/UNDERSCORE ELEV. + 10'-8"
- T/WINDOW ELEV. + 9'-4"
- T/SILL ELEV. + 2'-0"
- T/SLAB ELEV. + 0'-0"

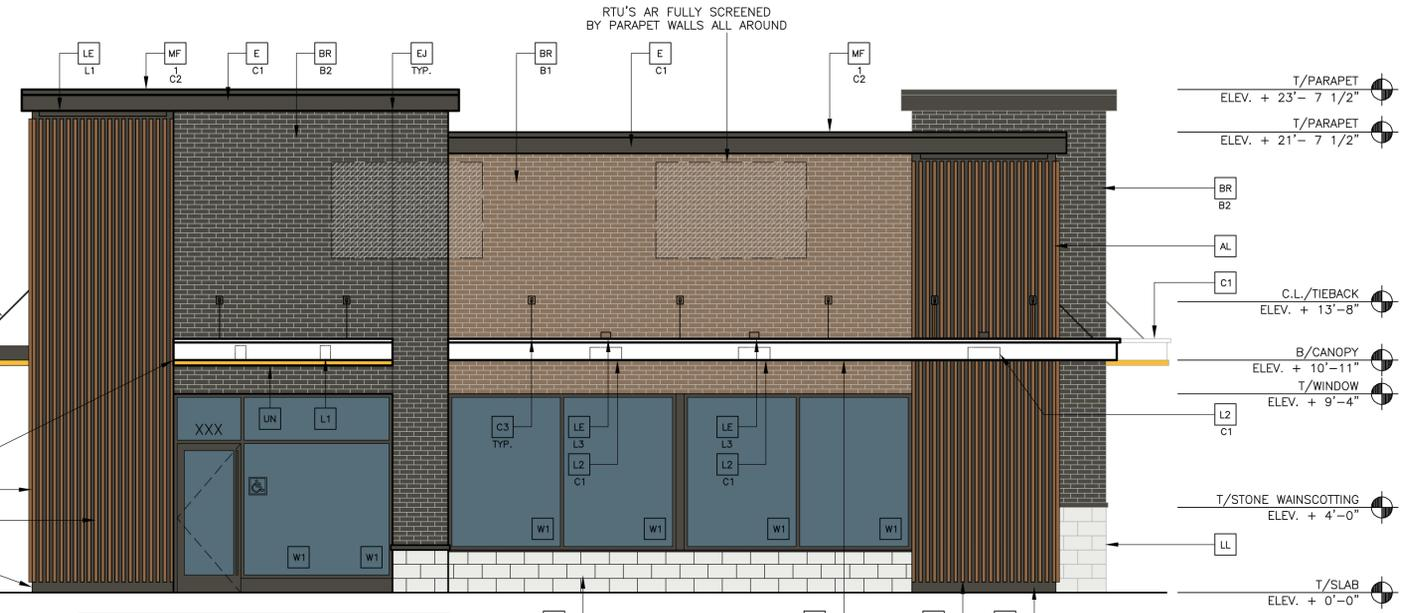

1 FRONT ELEVATION - SOUTH
1/4" = 1'-0"

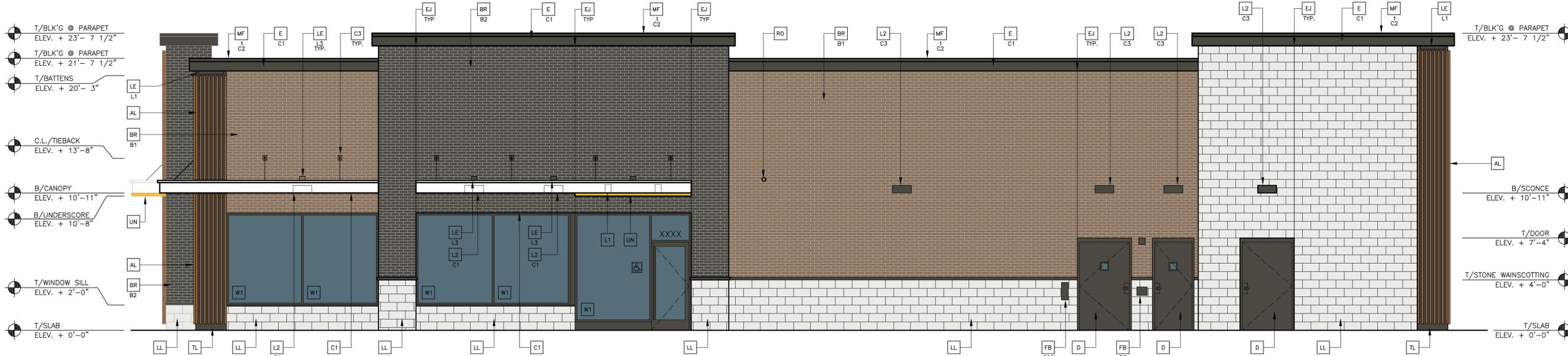

2 NON-DRIVE-THRU ELEVATION - EAST
1/4" = 1'-0"

KEY NOTES:

- AP ALPOLIC METAL PANEL (COLOR: RAL 7022)
- BR MODULAR FACE BRICK COLOR: B1 = "MUSHROOM BROWN" BY ACME BRICK COMPANY B2 = "EBONY" SMOOTH BY ACME BRICK COMPANY (MORTAR TO MATCH BRICK COLOR AS MUCH AS POSSIBLE)
- AL ALUMINUM BATTEN SYSTEM MFR: B+N INDUSTRIES SIZE: 2"x2" PROFILE COLOR: WOOD GRAIN, BACKRAIL UNFINISHED, ENDCAP PAINTED TO MATCH SUBSTRATE: 1/2" EXTERIOR HIGH DENSITY OVERLAY (HDO) PLYWOOD, BB, GROUP 1. HDO BOTH FACES. APAP TRADEMARKED. COURSE GRIT SAND SURFACES PRIOR TO PRIMING. PRIME AN DPAINT BOTH SIDES AND ALL EDGES. SUBSTRATE COLOR: "IRON ORE" SW 7069 BY SHERWIN WILLIAMS
- TL TRU EXTERIOR 1"x6" TRIM, PAINTED ON SITE COLOR: "IRON ORE" SW 7069 BY SHERWIN WILLIAMS
- C1 ALUMINUM CANOPY SYSTEM W/FASCIA COLOR: WHITE
- C2 ALUMINUM CANOPY SYSTEM COLOR: RAL 7022
- C3 ALUMINUM CANOPY TIEBACK COLOR: RAL 7022 GC TO PROVIDE CONTINUOUS BLOCKING ON WALL BEHIND TIEBACKS, WHEN TIEBACKS ARE INSTALLED ON METAL PANELING. SEE DETAIL 3/A5.0
- EJ EXPANSION JOINT, SEE DETAIL 7/A4.1
- FB CO2 = BULK CO2 FILL BOX (EQPM SCHEDULE ITEM 49.00) BO = BULK OIL FILL BOX (EQPM SCHEDULE ITEM 700.18)
- D HOLLOW METAL DOOR PAINT: "GAUNTLET GREY" SW7019 BY SHERWIN WILLIAMS
- DE DECAL BY GRAPHICS SUPPLIER SURFACE APPLIED, FIELD INSTALLED, PRE CUT, PRE SPACED. SUPPLIERS: VOMELA (865) 330-7337, ann.bowen@vomela.com GFX INTERNATIONAL (847) 543-4600, mcdonaldsdecor@gfxi.com
- SR 12" STANDING SEAM METAL SLOPED ROOF OVER METAL AWNING FRAME (COLOR DARK BRONZE)
- LL LIMESTONE BY SALADO LIMESTONE (ARCHITECTURAL CUT) COLOR: LINEN (RUNNING BOND) SIZE: 8"x16"x4" FINISH: SMOOTH
- LIMESTONE TO HAVE 1/4" RAKED MORTAR JOINTS (MORTAR COLORS TO BE LIGHT BUFF) SUBMIT TO ARCHITECT FOR APPROVAL
- GR GUARD RAIL -SEE SITE PLAN FOR EXACT LOCATION AND LENGTH USE STAINLESS STEEL OR GALVANIZED STEEL
- L1 RECESSED DOWN LIGHT FIXTURE - SEE ELECTRICAL COLOR: GOLD
- W1 EXTERIOR WINDOW ASSEMBLY - TEMPERED GLASS COLOR: EXTRA DARK BRONZE
- W2 DRIVE-THRU WINDOW BY READY ACCESS MODEL: 600 SERIES, 36" SERVICE HEIGHT WITH TRANSOM, MANUAL OPEN, ELECTRONIC RELEASE COLOR: DEEP BRONZE SLIDE DIRECTION: RL = RIGHT TO LEFT LR = LEFT TO RIGHT
- L2 RADIAL SCONCE LIGHT FIXTURE - SEE ELECTRICAL C1-COLOR: C1= WHITE C2= PLATINUM SILVER C3= DARK BRONZE
- LE ACCENT LIGHTING - SEE ELECTRICAL L1-LED LIGHT: L1 = SLIM LED (DOWN ONLY) L2 = INTEGRAL CANOPY FIXTURE L3 = UP ONLY FLOOD FIXTURE
- MF METAL FASCIA C1-TYPE: 1 = PRE-FAB ANCHOR-TITE FASCIA 2 = BOTTOM TRIM AT METAL REVEAL PANEL 3 = VERTICAL TRIM AT METAL REVEAL PANEL CORNERS, CLOSURES COLOR: C1= WEATHERED ZINC C2= RAL 7022
- AW METAL AWNINGS WITH ALUMINUM SUPPORT BRACKETS, BY CANOPY VENDOR (COLOR DARK BRONZE)
- PB PIPE BOLLARD - PAINTED YELLOW
- PT (RIMC) COIN COLLECTOR MODEL: #WPT STD CALL 1-888-743-7435 TO ORDER
- RO ROOF RAIN OVERFLOW PIPE PAINT TO MATCH SURROUNDING MATERIAL
- S McDONALD'S SIGNAGE BY OTHERS - UNDER SEPARATE PERMIT. C1-COLOR: C1= WEATHERED ZINC RACEWAY C2= RAL 7022 RACEWAY FOR SPECIFICATION.
- ST CO2 STROBE/ALARM. SEE MECHANICAL DRAWINGS FOR SPECIFICATION.
- UN METAL UNDERSCORE COLOR: GOLD
- E 7/8" 3-COAT STUCCO SYSTEM, REF WALL ASSEMBLY NOTES C1-"IRON ORE" SW 7069 BY SHERWIN WILLIAMS

REQUIRED ARCHITECTURAL ELEMENTS:

1. CANOPIES, AWNINGS OR PORTICOS (AWNINGS & CANOPIES PROVIDED)
2. ARTICULATED GROUND FLOOR LEVELS OR BASES (STONE BASE PROVIDED)
3. ARTICULATED CORNICE LINE (PROVIDED)
4. DISPLAY WINDOWS (PROVIDED)

GENERAL OVERLAY DISTRICT STANDARDS:

1. INCREASED LANDSCAPING (PROVIDED REF CIVIL PACKAGE)
2. MASONRY BUILDING PERCENTAGES (87.71% PROVIDED)
3. INCLUSION OF NATURAL/CULTURED STONE (23.61% PROVIDED)
4. VERTICAL ARTICULATION PROVIDED ON EAST/WEST ELEVATIONS

REGISTERED ARCHITECT
SHERWIN WILLIAMS
STATE OF TEXAS
1924

PREPARED FOR: **McDonald's USA, LLC**

PREPARED BY: **JAW**

DRAWN BY: **JAW**

STD ISSUE DATE: **2023**

REVIEWED BY: **JAW**

DATE ISSUED: **10/06/2023**

SITE ADDRESS: **042-3426 NMC OF STATE HWY 205 & FM 549, ROCKWALL, TEXAS**

TITLE: **2023 CUSTOM BUILDING DESIGN 4597-WOOD/WOOD**

DESCRIPTION: **WOOD BEARING WALLS W/4" BRICK VENEER WOOD ROOF TRUSS FRAMING STONE/BATTEN/BRICK EXTERIOR FINISH**

JAWA 23-0036

A2.0

ELEVATIONS

CASE #SP2023-035

PLANNING DEPARTMENT COMMENTS

12/11/2023

REV. DATE DESCRIPTION

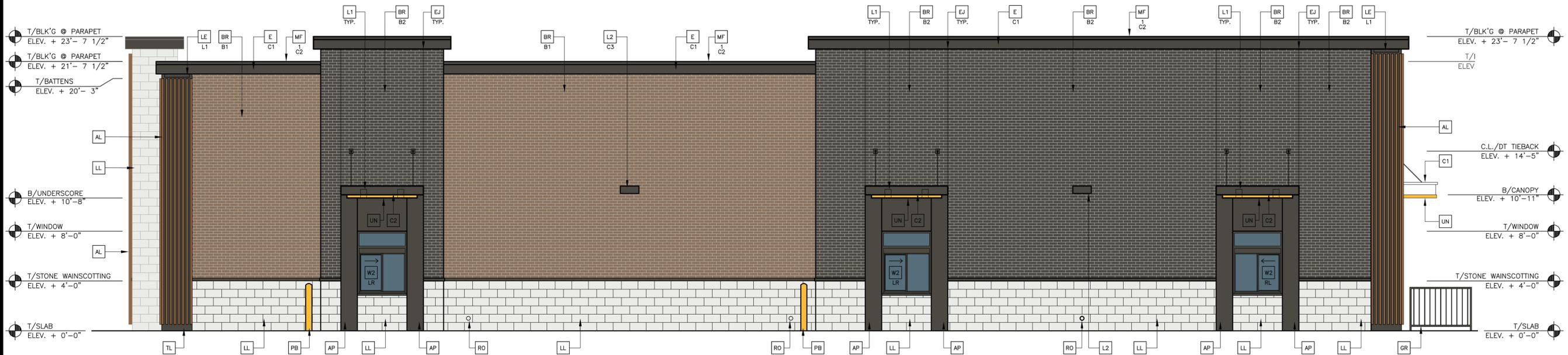

1 DRIVE THRU ELEVATION - WEST
A2.1 1/4" = 1'-0"

Materials	South Elevation		East Elevation		West Elevation		North Elevation		Totals		Total Masonry
	SF	%	SF	%	SF	%	SF	%	SF	%	
Brick	511	61.71%	1,234	61.79%	1,559	70.16%	376	32.14%	3,680	59.19%	87.71%
Limestone	71	8.57%	554	27.74%	303	13.64%	540	46.15%	1,468	23.61%	
Stucco	50	6.04%	103	5.16%	102	4.59%	50	4.27%	305	4.91%	
Wood Look Battens	196	23.67%	106	5.31%	106	4.77%	204	17.44%	612	9.84%	
Metal Paneling	0	0.00%	0	0.00%	152	6.84%	0	0.00%	152	2.44%	
Totals (Excluding Glazing)	828	100%	1,997	100%	2,222	100%	1,170	100%	6,217	100%	

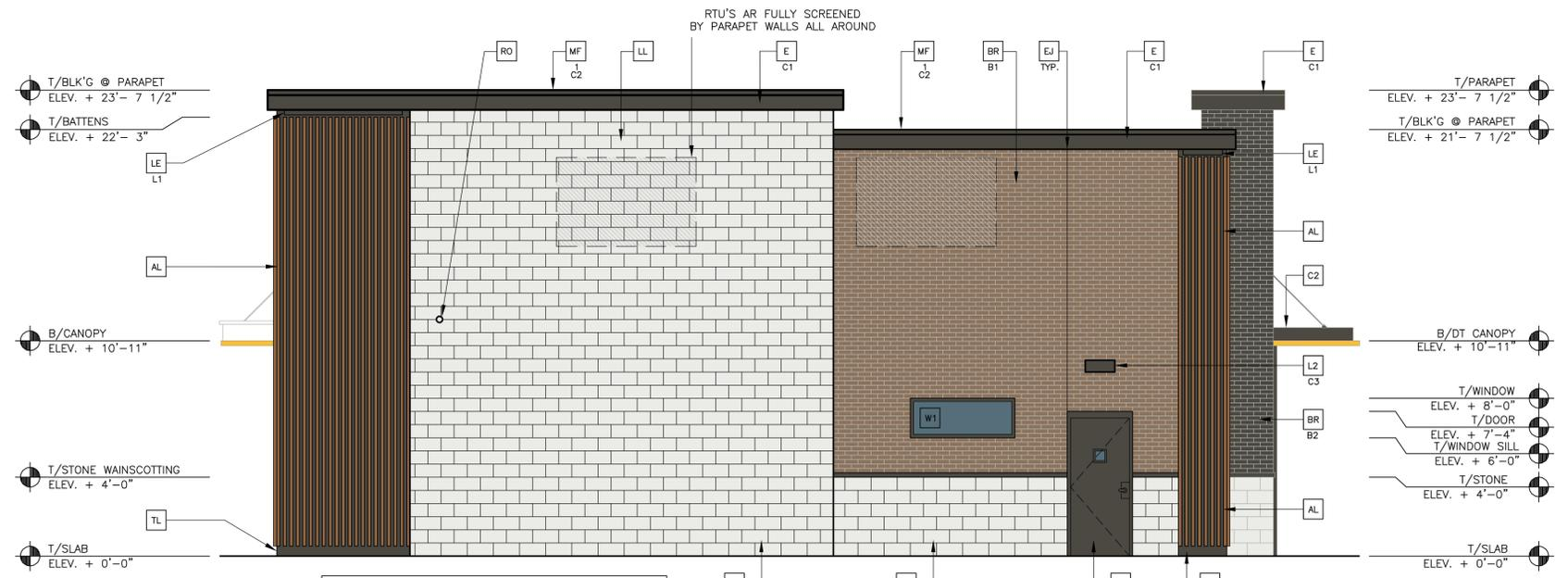

2 REAR ELEVATION - NORTH
A2.1 1/4" = 1'-0"

KEY NOTES:

- AP ALPOLIC METAL PANEL (COLOR: RAL 7022)
- BR MODULAR FACE BRICK COLOR:
B1 = "MUSHROOM BROWN" BY ACME BRICK COMPANY
B2 = "EBONY" SMOOTH BY ACME BRICK COMPANY
(MORTAR TO MATCH BRICK COLOR AS MUCH AS POSSIBLE)
- AL ALUMINUM BATTEN SYSTEM
MFR: BLN INDUSTRIES
SIZE: 2"x2" PROFILE
COLOR: WOOD GRAIN, BACKRILL UNFINISHED, ENDCAP PAINTED TO MATCH SUBSTRATE; 1/2" EXTERIOR HIGH DENSITY OVERLAY (HDO) PLYWOOD, BB, GROUP 1. HDO BOTH FACES. APAP TRADEMARKED, COURSE GRIT SAND SURFACES PRIOR TO PRIMING. PRIME AN DPAINT BOTH SIDES AND ALL EDGES.
SUBSTRATE COLOR: "IRON ORE" SW 7069 BY SHERWIN WILLIAMS
- TL TRU EXTERIOR 1"x6" TRIM, PAINTED ON SITE
COLOR: "IRON ORE" SW 7069 BY SHERWIN WILLIAMS
- C1 ALUMINUM CANOPY SYSTEM W/FASCIA
COLOR: WHITE
- C2 ALUMINUM CANOPY SYSTEM
COLOR: RAL 7022
- C3 ALUMINUM CANOPY TIEBACK
COLOR: RAL 7022
GC TO PROVIDE CONTINUOUS BLOCKING ON WALL BEHIND TIEBACKS, WHEN TIEBACKS ARE INSTALLED ON METAL PANELING.
SEE DETAIL 3/AS.0
- EJ EXPANSION JOINT, SEE DETAIL 7/A4.1
- FB CO2 = BULK CO2 FILL BOX (EQPM SCHEDULE ITEM 49.00)
BO = BULK OIL FILL BOX (EQPM SCHEDULE ITEM 700.18)
- D HOLLOW METAL DOOR
PAINT: "GAUNTLET GREY" SW7019 BY SHERWIN WILLIAMS
- DE DECAL BY GRAPHICS SUPPLIER
SURFACE APPLIED, FIELD INSTALLED, PRE CUT, PRE SPACED.
SUPPLIERS:
VOMELA (865) 330-7337, ann.bowen@vomela.com
GFX INTERNATIONAL (847) 543-4600, mcdonaldsdecor@gfxi.com
- SR 12" STANDING SEAM METAL SLOPED ROOF OVER METAL AWNING FRAME (COLOR DARK BRONZE)
- LL LIMESTONE BY SALADO LIMESTONE (ARCHITECTURAL CUT)
COLOR: LINEN (RUNNING BOND) SIZE: 8"x16"x4"
FINISH: SMOOTH
- LIMESTONE TO HAVE 1/4" RAKED MORTAR JOINTS (MORTAR COLORS TO BE LIGHT BUFF)
SUBMIT TO ARCHITECT FOR APPROVAL
- GR GUARD RAIL -SEE SITE PLAN FOR EXACT LOCATION AND LENGTH
USE STAINLESS STEEL OR GALVANIZED STEEL
- L1 RECESSED DOWN LIGHT FIXTURE - SEE ELECTRICAL
COLOR: GOLD
- W1 EXTERIOR WINDOW ASSEMBLY - TEMPERED GLASS
COLOR: EXTRA DARK BRONZE
- W2 DRIVE-THRU WINDOW BY READY ACCESS
MODEL: 600 SERIES, 36" SERVICE HEIGHT WITH TRANSOM, MANUAL OPEN, ELECTRONIC RELEASE
COLOR: DEEP BRONZE
SLIDE DIRECTION: RL = RIGHT TO LEFT
LR = LEFT TO RIGHT
- L2 RADIAL SCONCE LIGHT FIXTURE - SEE ELECTRICAL
C1= COLOR:
C1 = WHITE
C2 = PLATINUM SILVER
C3 = DARK BRONZE
- LE ACCENT LIGHTING - SEE ELECTRICAL
L1= LED LIGHT:
L1 = SLIM LED (DOWN ONLY)
L2 = INTEGRAL CANOPY FIXTURE
L3 = UP ONLY FLOOD FIXTURE
- MF METAL FASCIA
C1= TYPE:
1 = PRE-FAB ANCHOR-TITE FASCIA
2 = BOTTOM TRIM AT METAL REVEAL PANEL
3 = VERTICAL TRIM AT METAL REVEAL PANEL CORNERS, CLOSURES
COLOR:
C1 = WEATHERED ZINC
C2 = RAL 7022
AW METAL AWNINGS WITH ALUMINUM SUPPORT BRACKETS, BY CANOPY VENDOR (COLOR DARK BRONZE)
- PB PIPE BOLLARD - PAINTED YELLOW
- PT (RHM) COIN COLLECTOR
MODEL: #WPT STD
CALL 1-888-743-7435 TO ORDER
- RO ROOF RAIN OVERFLOW PIPE PAINT TO MATCH SURROUNDING MATERIAL
- S McDONALD'S SIGNAGE BY OTHERS - UNDER SEPARATE PERMIT.
C1= COLOR:
C1 = WEATHERED ZINC RACEWAY
C2 = RAL 7022 RACEWAY
- ST CO2 STROBE/ALARM. SEE MECHANICAL DRAWINGS FOR SPECIFICATION.
- UN METAL UNDERSCORE
COLOR: GOLD
- E 7/8" 3-COAT STUCCO SYSTEM, REF WALL ASSEMBLY NOTES
C1="IRON ORE" SW 7069 BY SHERWIN WILLIAMS

REQUIRED ARCHITECTURAL ELEMENTS:

1. CANOPIES, AWNINGS OR PORTICOS (AWNINGS & CANOPIES PROVIDED)
2. ARTICULATED GROUND FLOOR LEVELS OR BASES (STONE BASE PROVIDED)
3. ARTICULATED CORNICE LINE (PROVIDED)
4. DISPLAY WINDOWS (PROVIDED)

GENERAL OVERLAY DISTRICT STANDARDS:

1. INCREASED LANDSCAPING (PROVIDED REF CIVIL PACKAGE)
2. MASONRY BUILDING PERCENTAGES (87.71% PROVIDED)
3. INCLUSION OF NATURAL/CULTURED STONE (23.61% PROVIDED)
4. VERTICAL ARTICULATION PROVIDED ON EAST/WEST ELEVATIONS

PREPARED BY: JAW ARCHITECTS
 DRAWN BY: JAW
 STD ISSUE DATE: 2023
 REVIEWED BY: JAW
 DATE ISSUED: 10/06/2023
 TITLE: 2023 CUSTOM BUILDING DESIGN 4597-WOOD/WOOD
 DESCRIPTION: WOOD BEARING WALLS W/4" BRICK VENEER WOOD ROOF TRUSS FRAMING STONE/BATTEN/BRICK EXTERIOR FINISH
 SITE ID: 042-3426
 SMC OF STATE HWY 205 & FM 549, ROCKWALL TEXAS
 SHEET NO. JAWA 23-0038
A2.1
 ELEVATIONS
 CASE #SP2023-035
 12/11/2023 PLANNING DEPARTMENT COMMENTS
 REV DATE DESCRIPTION
 1 12/11/2023 PLANNING DEPARTMENT COMMENTS
 1 12/11/2023 PLANNING DEPARTMENT COMMENTS

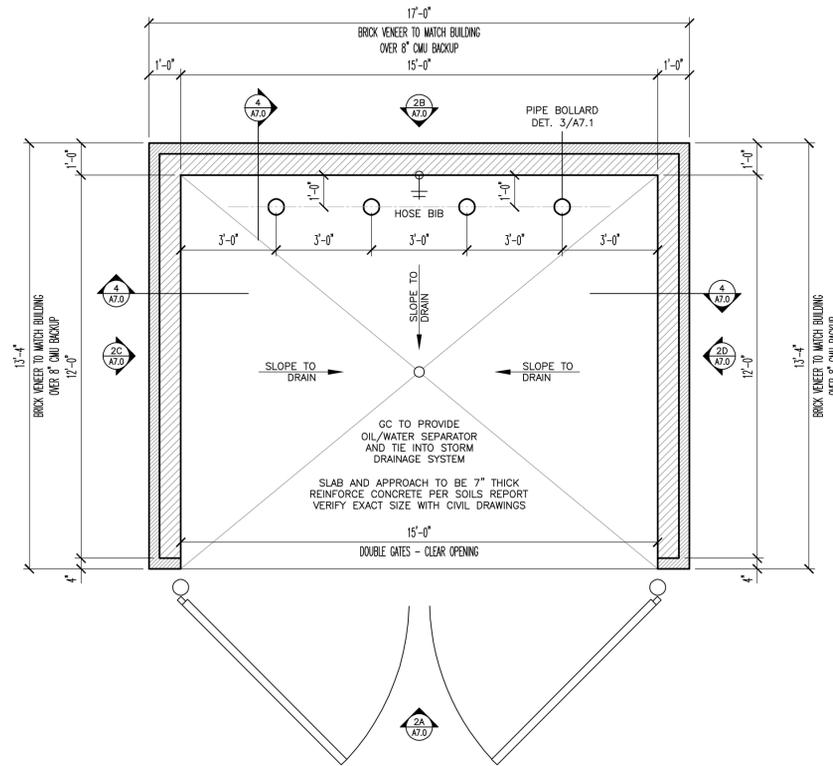

1 DUMPSTER ENCLOSURE PLAN SCALE 3/8"=1'-0"

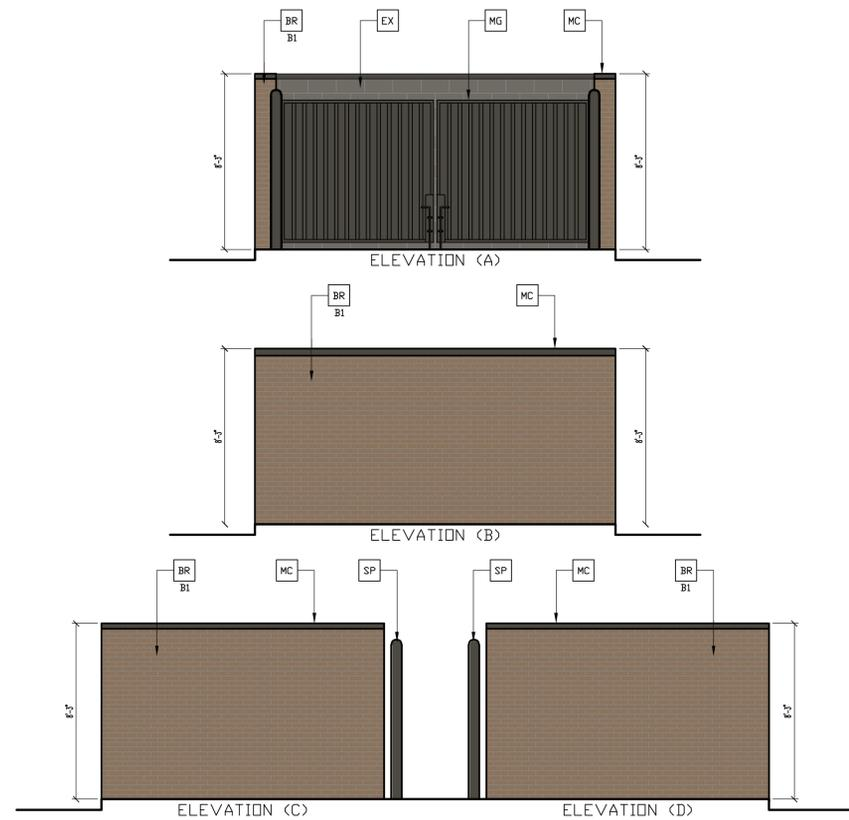

2 DUMPSTER ELEVATIONS SCALE 1/4"=1'-0"

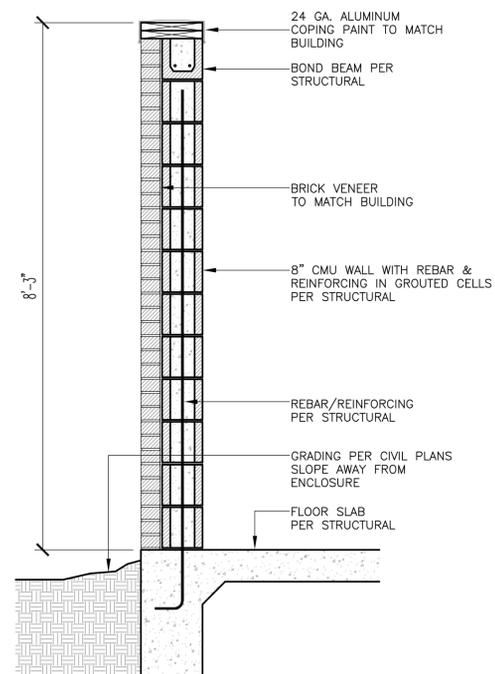

4 WALL SECTION DETAIL SCALE 3/4"=1'-0"

KEY NOTES:

- BR MODULAR FACE BRICK
- B1 - COLOR: "MUSHROOM BROWN" BY AMCE BRICK COMPANY
- MC 24 GAUGE ALUMINUM COPING OVER CMU ENCLOSURE WALLS COLOR TO MATCH "MF-C2" RAL 7022
- SP STEEL CONCRETE FILLED POST PAINT TO MATCH BUILDING TRIM COLOR RAL 7022
- MG METAL DUMPSTER ENCLOSURE ENTRY GATES, REF METALS AND NOTES, COLOR RAL 7022
- EX GC TO PAINT EXPOSED CMU BLOCK (INSIDE ENCLOSURE) TO MATCH RAL 7022

GENERAL NOTES:

GENERAL CONTRACTOR TO PROVIDE 6 INCHES OF EXPOSED GRADE BREASTS AROUND THE STORAGE BUILDING WITH THE EXCEPTION OF THE DOOR LOCATION, COORDINATE WITH THE CIVIL GRADING PLANS.

5/8" PUDDLE WELD B/N DECK & ALL ANGLE TYPICAL IN EACH DECK FLUTE, PROVIDE #12 SCREWS @ 6" O.C. AT ALL DECK SIDE LAPS.

GENERAL CONTRACTOR TO SUPPLY AND INSTALL CORRUGATED METAL GATES (16 GAUGE) F-DECKING, ALL METAL TO BE PRIMED AND PAINTED TO MATCH THE BUILDING TRIM COLOR, VERIFY WITH ACM.

PROVIDE A 12"x12" LOUVER VENT IN HOLLOW METAL DOOR, SEE ELEVATIONS.

ELECTRICAL NOTES:

OCCUPANCY SENSOR: GC TO PROVIDE A WALL MOUNTED OCCUPANCY SENSOR, REF ELECTRICAL PLANS FOR MORE INFORMATION.

GC TO INSTALL NEW STRIP LIGHT FIXTURE, PER MANF.'S RECOMMENDATIONS. F25 - 42W LED BY COLUMBIA LIGHTING #LCL4-40ML-EDU.

GC TO PROVIDE A 20A, 120V, RECEPTACLE WITHIN 25 FEET OF THE HVAC EQUIPMENT, PER CODE.

ALL LIGHTING/POWER SHALL BE CONNECTED TO AN APPROPRIATE CIRCUIT IN THE MAIN BUILDING PANELS, VERIFY CIRCUITING PRIOR TO ROUGH-IN.

PREPARED BY: JAW ARCHITECTS, P.C.
 11/06/23
 1
 PLANNING DEPARTMENT COMMENTS

REV. DATE DESCRIPTION BY

© 2023 McDonald's USA, LLC
McDonald's USA, LLC
 These drawings and specifications are the confidential and proprietary property of McDonald's USA, LLC and shall not be copied or reproduced for use on any other project without the prior written consent of McDonald's USA, LLC. Use of these drawings and specifications on any other project is unauthorized.

DRAWN BY: JAW
 STD ISSUE DATE: 2023
 REVIEWED BY: JAW
 DATE ISSUED: 10/06/2023

TITLE: 2023 CUSTOM BUILDING DESIGN
 4597-WOOD/WOOD

DESCRIPTION: WOOD BEARING WALLS W/4" BRICK VENEER
 WOOD ROOF TRUSS FRAMING
 STONE/BATTEN/BRICK EXTERIOR FINISH
 SITE ADDRESS: 042-3428 NMC OF STATE HWY 205 & FM 549, ROCKWALL TEXAS

SHEET NO. JAWA 23-0038
A7.0

CASE #SP2023-035

NOTES:
 1. THE FOOTCANDLE LEVELS AS SHOWN ARE BASED ON THE FOLLOWING CRITERIA. ANY SUBSTITUTIONS IN SPECIFIED FIXTURES OR CHANGES TO LAYOUT WILL AFFECT LIGHTING LEVELS SHOWN AND WILL NOT BE THE RESPONSIBILITY OF SECURITY LIGHTING.
 2. DISTANCE BETWEEN READINGS _____ 10'

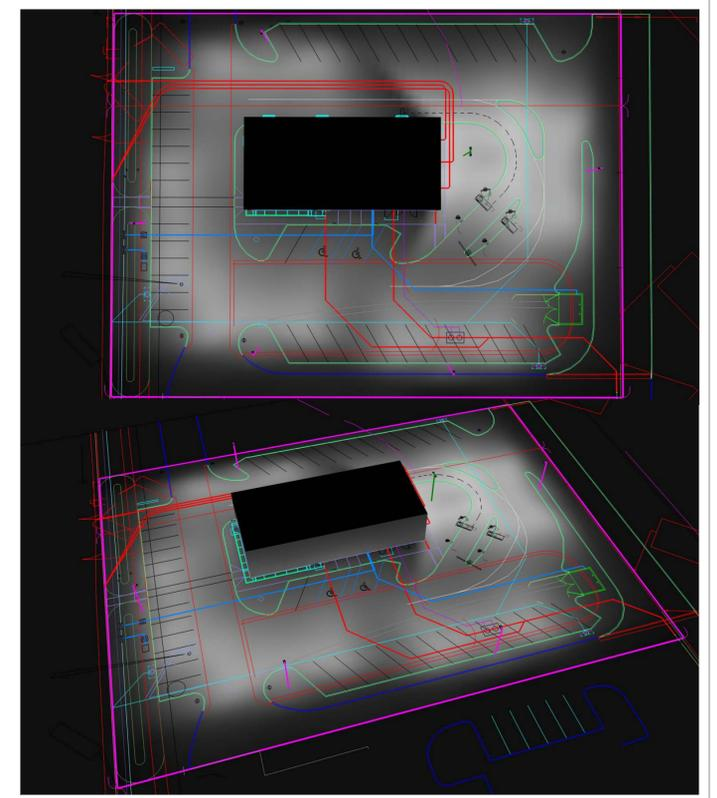
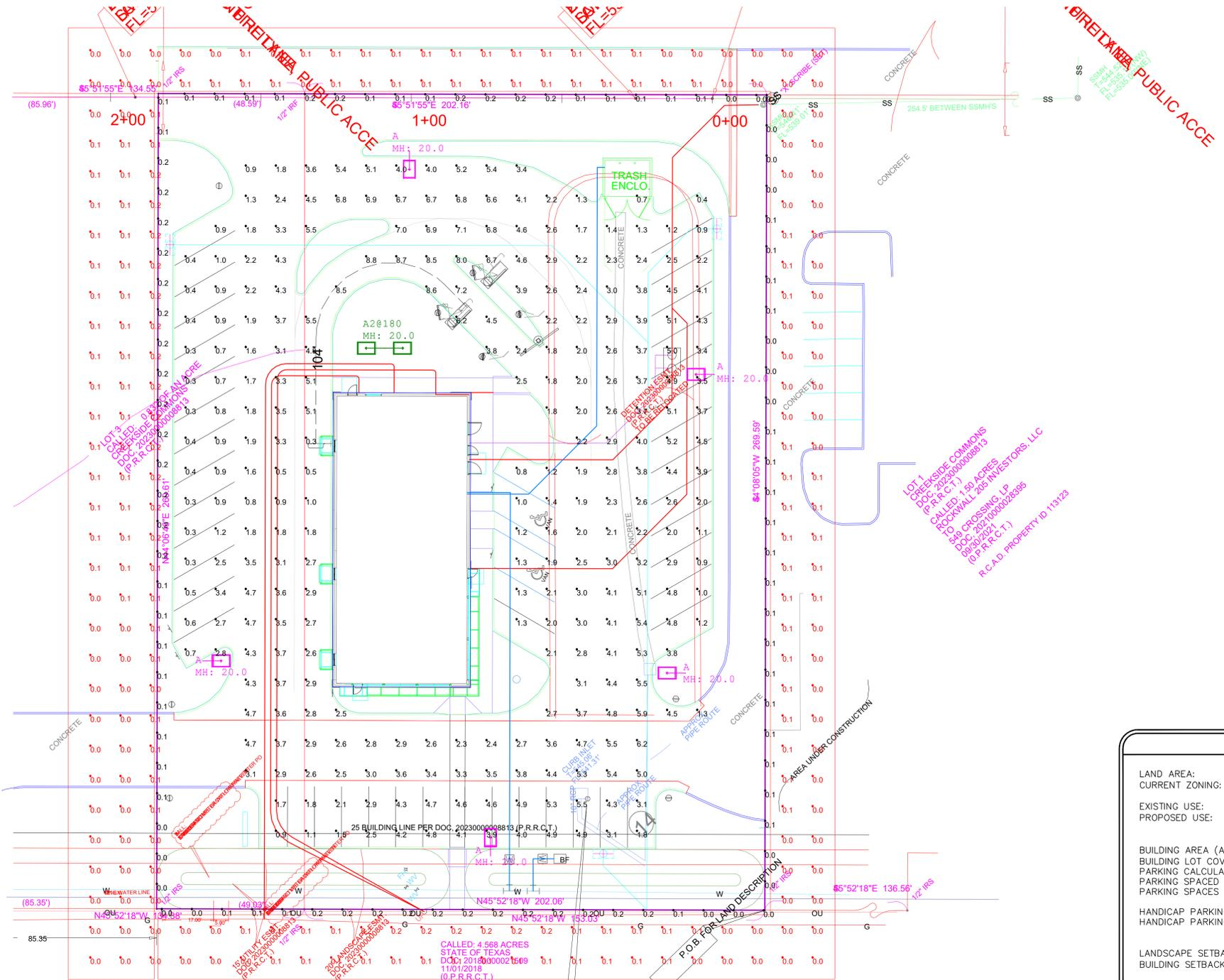

Pole Fixtures Are Full Cutoff
 Tilt=0
 Calculation Grids Are At Grade
 Pole Light Mounting Height=20ft
 (17' Pole + 3' Base)

SITE INFORMATION	
LAND AREA:	54,489 SF (1.251 AC)
CURRENT ZONING:	C-COMMERCIAL DISTRICT (SH205 OVERLAY DISTRICT)
EXISTING USE:	VACANT LOT
PROPOSED USE:	MCDONALD'S RESTAURANT W/DRIVE-THRU
BUILDING AREA (APPROXIMATE):	4,365 GFA
BUILDING LOT COVERAGE:	4,365 SF/54,489 SF = 8.01%
PARKING CALCULATIONS:	1 SPACE PER 100 SF
PARKING SPACES REQUIRED:	44
PARKING SPACES PROVIDED:	45
HANDICAP PARKING REQUIRED:	2
HANDICAP PARKING PROVIDED:	2
LANDSCAPE SETBACK:	20' FRONT; 5' REAR & SIDE
BUILDING SETBACK:	25' FRONT; 10' SIDES & REAR
EXISTING IMPERVIOUS AREAS:	13.9% (7,592 SF)
PROPOSED IMPERVIOUS AREAS:	64.4% (35,072 SF)
PROPOSED LANDSCAPE PERCENTAGE:	21.7% (11,825 SF)

Calculation Summary							
Label	CalcType	Units	Avg	Max	Min	Avg/Min	Max/Min
ADJACENT PROPERTY READINGS	Illuminance	Fc	0.07	0.2	0.0	N.A.	N.A.
PAVED SURFACE READINGS	Illuminance	Fc	3.16	8.8	0.3	10.53	29.33
PROPERTY LINE READINGS	Illuminance	Fc	0.11	0.2	0.0	N.A.	N.A.

Luminaire Schedule									
Symbol	Qty	Label	Arrangement	LLF	Description	Lum. Watts	EPA	Mtg Height	Pole Type
	5	A	Single	1.000	VP-2-320L-145-5K7-4W-DBS-HSS-90-B	145.6	0.607	20	SES-17-40-1-TA-GL-DB (4")
	1	A2@180	Back-Back	1.000	VP-2-320L-145-5K7-4W-DBS	150	0.607	20	SES-17-40-1-TA-GL-DB (4")

PROJECT WIND LOAD CRITERIA BASED ON:
 ASCE 7-10 WIND SPEEDS (3-SEC PEAK GUST MPH)
 50 YEAR MEAN RECURRENCE INTERVAL
 ALLOWED EPA XX-X @ WIND LOAD XX MPH

SECURITY LIGHTING™

2100 Gulf Road, Suite 400, Rolling Meadows, IL 60009
 1-800-544-4444

UNLESS OTHERWISE SPECIFIED, ALL DIMENSIONS ARE IN INCHES

SCALE 1"=20' 0"

DRAWN BY: **CLB LEED AP BD+C**

POINT-BY-POINT FOOTCANDLE PLOT FOR
 MCDONALD'S
 550 FARM TO MARKET RD 549
 ROCKWALL, TX 75082

NATIONAL STORE NUMBER
41096

DATE: 9/15/2023 DRAWING NUMBER: A231820A.AGI

THIS DRAWING MEETS OR EXCEEDS MCDONALD'S CURRENT ILLUMINATION SPECIFICATIONS OF A 3-4 FOOTCANDLE AVERAGE, UNLESS SUPERSEDED BY OTHER REQUIREMENTS.

1. THIS LIGHTING DESIGN IS BASED ON INFORMATION SUPPLIED BY OTHERS TO SECURITY LIGHTING SYSTEMS. SITE DETAILS PROVIDED HEREON ARE REPRODUCED ONLY AS A VISUALIZATION AID. FIELD DEVIATIONS MAY SIGNIFICANTLY AFFECT PREDICTED PERFORMANCE. PRIOR TO INSTALLATION, CRITICAL SITE INFORMATION (POLE LOCATIONS, ORIENTATION, MOUNTING HEIGHT, ETC.) SHOULD BE COORDINATED WITH THE CONTRACTOR AND/OR SPECIFIER RESPONSIBLE FOR THE PROJECT.

2. LUMINAIRE DATA IS TESTED TO INDUSTRY STANDARDS UNDER LABORATORY CONDITIONS. OPERATING VOLTAGE AND NORMAL MANUFACTURING TOLERANCES OF LAMP, BALLAST, AND LUMINAIRE MAY AFFECT FIELD RESULTS.

3. CONFORMANCE TO FACILITY CODE AND OTHER LOCAL REQUIREMENTS IS THE RESPONSIBILITY OF THE OWNER AND/OR THE OWNER'S REPRESENTATIVE.

4. THIS LAYOUT MAY NOT MEET TITLE 24 OR LOCAL ENERGY REQUIREMENTS. IF THIS LAYOUT NEEDS TO BE COMPLIANT WITH TITLE 24 OR OTHER ENERGY REQUIREMENTS, PLEASE CONSULT FACTORY WITH SPECIFIC DETAILS REGARDING PROJECT REQUIREMENTS SO THAT REVISIONS MAY BE MADE TO THE DRAWING.



November 9, 2023

City of Rockwall
Planning and Zoning
385 S Goliad Street
Rockwall, TX 75087

RE: McDonald's Variance – 550 FM 549, Rockwall, TX 75032

McDonald's is requesting a variance to the building articulation requirements as outlined in Subsection 04.01 of Article 05 of the City of Rockwall UDC. The ordinance requires that a five foot wall projection be added to the east and west sides of the building and this creates a hardship for this project due to the site size. To keep the aisle widths and turning radii required by the City of Rockwall Engineering Department, the building cannot project out any further than currently shown.

Attempts have been made to meet the intent of the ordinance by raising portions of the exterior walls three feet and bringing them out six additional inches from the adjacent wall portions. The building materials have been chosen to complement the nearby 7-11 and create a sense of cohesion and elevated finish design for the retail area. We have also added the following compensatory measures to our building and site to meet the requirements of the variance request:

1. Increased masonry percentages: the building will be over 93% masonry through a mix of brick and natural limestone.
2. The building exterior will be comprised of 39.49% natural limestone, significantly in excess of the 20% requirement.
3. Many architectural elements have been added to the building, including awnings over many windows and doors, a large section of spandrel glass between the drive-thru windows, and a cornice line around the top of the entire building.
4. The site has increased landscaping percentages above and beyond the requirements set forth in each portion of Section 5.03 of the Rockwall development code. We have also added an outdoor bench and planters to create additional interest in the area immediately surrounding the building.

Please feel free to contact me with any questions or concerns.

Thank you for reviewing our request,

Leslie Ford
Entitlements Consultant
Ofi Chito, LLC
325-370-9965
leslie@ofichito.com



October 19, 2023

City of Rockwall
Planning and Zoning
385 S Goliad Street
Rockwall, TX 75087

RE: McDonald's Variance – 550 FM 549, Rockwall, TX 75032

McDonald's is requesting a pitched roof variance on Section 04 – Subsection 04.01 General Commercial District Standards, (A) (1) Roof Design Standards. McDonald's prototypical roof is a non-pitched, flat roof. The design is consistent with other businesses in the area and will conform without causing the building to appear out of place.

With this variance we have included the compensatory measures:

1. Increased architectural elements (canopies, display windows, and cornice line provided)
2. Articulated ground floor levels or bases (stone base provided)

Please feel free to contact me with any questions or concerns.

Thank you for reviewing our request,

Leslie Ford

Leslie Ford
Entitlements Consultant
Ofi Chito, LLC
325-370-9965
leslie@ofichito.com

SP2023-049: Site Plan for a General Retail Building (Smoothie King)

Please address the following comments (*M= Mandatory Comments; I = Informational Comments*)

- I.1 This is a request for the approval of a *Site Plan* for *General Retail Building* on a 0.7621-acre portion of a larger 2.542-acre parcel of land identified as Lot 1, Block A, Pecan Valley Retail Addition, City of Rockwall, Rockwall County, Texas, zoned Planned Development District 65 (PD-65) for General Retail (GR) District, situated within the North SH-205 Overlay (N. SH-205 OV) District, and addressed as 150 Pecan Valley Drive.
- I.2 For questions or comments concerning this case please contact Angelica Guevara in the Planning Department at (972) 772-6438 or email aguevara@rockwall.com.
- M.3 For reference, include the case number (*SP2023-049*) in the lower right-hand corner of all pages of all revised plan submittals. (*Subsection 01.02(D), Article 11, Unified Development Code [UDC]*)
- M.4 Provide a corrected signature block as shown below with signature space for the Planning and Zoning Chairman and the Planning Director on all pages of the plans. Please remove the year '2021' and replace with '2024'. (*Subsection 03.04. A, of Article 11, UDC*)

APPROVED:

I hereby certify that the above and foregoing site plan for a development in the City of Rockwall, Texas, was approved by the Planning & Zoning Commission of the City of Rockwall on the ____ day of _____, ____.

WITNESS OUR HANDS, this ____ day of _____, _____.

Planning & Zoning Commission, Chairman

Director of Planning and Zoning

M.5 Site Plan

- (1) Please label the fire lanes as Fire Lane, Public Access, and Utility Easement. (*Subsection 03.04. B, of Article 11, UDC*)
- (2) Provide dumpster enclosure elevations; the dumpster enclosure gate must be self-latching. (*Subsection 01.05. B, of Article 05, UDC*)
- (3) Are there any roof mounted or pad mounted utility equipment? If so, indicate them on the site plan and building elevations and show any subsequent required screening. (*Subsection 01.05. C, of Article 05, UDC*)
- (4) According to Subsection 06.02.(D) of Article 05, *District Development Standards*, of the Unified Development Code (UDC) states that cross access easements may be required by the Planning and Zoning Commission at the time of site plan approval to ensure access to future median breaks and to reduce the number of curb cuts need along roadways. Please change the *Proposed Firelane, Utility, & Drainage Easement* to a *Proposed Firelane, Utility, Drainage, & Cross Access Easement*.
- (5) Please provide an elevation of the proposed dumpster enclosure. Per the Unified Development Code (UDC) this enclosure shall be finished in the same materials as the primary structure, shall have a self-latching gate, and shall be a minimum of eight (8) feet in height.
- (6) All parking spaces should be 20' in length and 9' in width as explained in the Standards of Design and Construction. Please correct this on the site plan.

M.5 Building Elevations:

- (1) Please change *Stucco Veneer* to *3-Part Stucco* (*i.e. Stucco Veneer is not a primary materials*).
- (2) According to Subsection 06.02.(C)(2) of Article 05, *District Development Standards*, of the Unified Development Code (UDC), "(a)ll structures that have a building footprint of less than 6,000 SF shall be constructed with a pitched roof." In this case, staff agrees that this structure should be constructed with a flat roof and parapet to match the adjacent existing general retail strip center; however, this request will require a variance from the Planning and Zoning Commission.
- (3) Subsection 06.02.(C)(3) of Article 05, *District Development Standards*, of the Unified Development Code (UDC), requires that all buildings shall be designed so that all RTU's are screened from public rights-of-way. In this case, the east building elevation has an RTU that extends above the parapet wall. Please increase the heights of the parapets to properly screen this RTU. Alternatively, a louver system maybe used to screen the RTU.

- (4) Subsection 06.02.(C)(4) of Article 05, *District Development Standards*, of the Unified Development Code (UDC), requires a minimum of four (4) architectural elements for buildings less than 50,000 SF. Currently, staff has identified two (2) architectural elements from the list in this section (*i.e. canopies and display windows*). Staff should note that this building does not meet the articulation requirements and, therefore, staff cannot count recesses/projections and/or varied roof heights. Please add two (2) additional elements.
- (5) Subsection 06.02.(C)(5) of Article 05, *District Development Standards*, of the Unified Development Code (UDC), "(a)ll buildings shall be architecturally finished on all four (4) sides utilizing the same materials, detailing, articulation and features." Currently, the building does not meet the articulation requirements, and is not finished utilizing the same detailing and features on three (3) of the four (4) sides. Staff would recommend that additional display windows and canopies be added to these three (3) sides.
- (6) Subsection 04.01(C) of Article 05, *District Development Standards*, of the Unified Development Code (UDC) details the building articulation requirements. Currently, the proposed building does not meet the primary building facades (*i.e. since this project is in an overlay district the primary building façade formula are required on all four [4] sides of the building*). Specifically, the proposed building does not meet the projection height (*i.e. there is only a two [2] foot projection as opposed to the required 5.75' projection on all building facades*) and wall projection (*there is 1-foot, 11 ¾ inch projection on the east elevation and no project on the north elevation*), and there is not a primary entryway/architectural element on three (3) of the four (4) building facades.
- (7) Subsection 04.01 (A) of Article 05, *District Development Standards*, of the Unified Development Code (UDC), indicates that the back of the parapets shall be finished using the same materials as the exterior.

M.6 Landscape Plan

- (1) According to Subsection 05.01(B) of Article 08, *Landscape and Fence Standards*, of the Unified Development Code (UDC), a ten (10) foot landscape buffer with built-up berm, ground cover, and shrubbery is required adjacent to Pecan Valley Drive and W. Quail Run Road. In addition, this landscape buffer requires a minimum of one (1) canopy tree and one (1) accent tree per 50-linear feet.
- (2) According to Subsection 06.02.(E) of Article 05, *District Development Standards*, of the Unified Development Code (UDC), a 20-foot landscape buffer is required along SH-205. Within this landscape buffer a minimum of two (2) canopy trees and four (4) accent trees per 100-LF are required to be provided. This means that the trees required for this project along SH-205 would be three (3) canopy trees and five (5) accent trees. In addition, a built-up berm, ground cover, and shrubbery is required along the entire length of the landscape buffer.
- (3) Please identify all required landscape buffers and berms on the Landscape Plan.
- (4) Please note that all retaining walls shall be finished in rock or stone.

M.7 Photometric Plan

- (1) Per the Photometric Plan the proposed mounting height of the lighting standards in the parking areas is 25-feet. Please note that Subsection 06.02.(G) of Article 05, *District Development Standards*, of the Unified Development Code (UDC) stipulates a maximum height of 20-feet for all light standards, light fixture, light pole, pole base or combination thereof. Please make the required correction.
- (2) According to Subsection 03.03(C) of Article 07, *Environmental Performance*, of the Unified Development Code (UDC) the maximum allowable light intensity measured at the property line of any non-residentially zoned lot shall be 0.2 FC. Please note that the current plans exceed this adjacent to all property lines. Please correct this issue.
- (3) Please provide cut sheets/specification sheets for ALL proposed light fixtures.
- (4) Please provide an exhibit showing conformance to the headlight screening standards (*i.e. show that the parking spaces along SH-205 will be properly screened in accordance with Article 08 of the UDC*).

M.8 Treescape Plan

- (1) The proposed *Treescape Plan* does not meet the requirements of Article 09, *Tree Preservation*, of the Unified Development Code (UDC). Specifically, the mitigation is not calculated correctly and is not in the format required by the UDC (*see Table 2 below*). The required mitigation for this site is 481 caliper inches. Please revise the mitigation totals as provided by staff.

TABLE 2: EXAMPLE OF TREESCAPE PLAN SPREADSHEET

#	SPECIES	CALIPER	PROTECT OR REMOVE	TREE HEALTH (1-5)	DISEASE (Y/N)	INSECT (Y/N)	STRUCTURAL (Y/N)	MITIGATION REQUIRED
1	Live Oak	4" Caliper	Remove	2	Y	Y	Y	0
2	Cedar	10' Tall	Remove	4	N	N	N	4"
3	Red Oak	26" Caliper	Remove	3	N	N	N	52"
TOTAL:								56"

TREE HEALTH: 1: DEAD; 2: DISEASE/STRUCTURAL ISSUES; 3: VIABLE TREE WITH CARE; 4: GOOD HEALTH; 5: EXCELLENT HEALTH

TREE GRADES: 1-2: NOT PROTECTED; 3-5: PROTECTED

- (2) Please provide a copy of the Landscape Plan from the agreement on the City's property. This can be combined with the totals from the Landscape Plan to off-set the required tree mitigation balance.
- (3) Please remove the "Proposed Plantings" from the Treescape Plan.
- (4) Please note that all trees being removed are to be mitigated.

M.9 Staff has identified the following variances based on the plans that were submitted: [1] Roof Design Standards, [2] Mechanical Equipment Screening, [3] Four (4) Sided Architecture, [4] Primary Articulation, [5] Lighting Standards, and [6] Light at Non-Residential Property Line. Some of these variances can be corrected by changing the plans to conform to the code requirements; however, should you choose to request variances with this case please provide a letter that outlines each requested variance, the reason the variance is being requested (*i.e. the hardship that prevents you from meeting the code requirements*), and the required two (2) compensatory measures required by the code to request the variance. Please note that the compensatory measures must directly off-set the requested variance. In this case, twelve (12) compensatory measures would be needed in lieu of the six (6) variances requested. Variances require a super-majority vote (*or three-fourths vote*) of the Planning and Zoning Commission for approval (*e.g. six [6] out of the seven [7] members*).

M.10 Based on the variances being proposed, staff would suggest the following:

- (1) Remove the six (6) parking spaces along Pecan Valley Drive. Currently, there is a surplus of seven (7) spaces shown on the site plan. By removing these spaces there is additional area to meet the landscaping requirements or to add additional landscaping as a compensatory measure.
- (2) Provide the required projections on the buildings and increase parapet height. The maximum height for the district is 28-feet and the current building is at 25-feet. This leaves three (3) additional feet to better conform to the articulation requirements and better screen the RTU's.
- (3) Due to the close proximity of the wildlife preserve and bike trails nearby, additions of bike racks would be appropriate for this request as a compensatory measure.

I.7 Please note that failure to address all comments provided by staff will result in the automatic denial of the case on the grounds of an incomplete submittal. No refund will be given for cases that are denied due to an incomplete submittal, and a new application and fee will be required to resubmit the case.

I.8 Staff has identified the aforementioned items necessary to continue the submittal process. Please make these revisions and corrections, and provide any additional information that is requested. It is encouraged for applicants to submit revisions as soon as possible to give staff ample time to review the case prior to the January 9, 2024 Planning & Zoning Meeting.

I.9 Please note the scheduled meetings for this case:

- 1) Planning & Zoning Work Session will be held on December 27, 2023.
- 2) Planning & Zoning Public Hearing will be held on January 9, 2024.

I.10 All meetings will be held in person and in the City's Council Chambers. All meetings listed above are scheduled to begin at 6:00 p.m. (P&Z). The City prefers that a representative(s) be present for these meetings. During the upcoming work session meeting with the Planning and Zoning Commission, representative(s) are expected to present their case and answer any questions the Planning Commission may have regarding this request.

- I.11 If the Planning and Zoning Commission approves this site plan case, the applicant will be responsible for submitting hard copies of the final site plan submittal package -- *with all comments addressed* -- for signatures from the Planning and Zoning Commission Chairman and Director of Planning and Zoning. Please note that this will be required to be completed prior to the acceptance of civil engineering plans.

Engineering:

1. This existing stream is WOTUS.
2. Oil/water separator for dumpster drainage.
3. No retaining walls in easements
4. All parking spaces must be 20'x9'.
5. Min 20' easement.
6. Manhole & Sewer not shown.
7. Minimum width is 2 times depth plus width of culvert, raised to the nearest 5 ft, centered on pipe.
8. 3,600 psi (min 6.5 sack mix).
9. Min 5.5 sack mix.
10. Remove all trees from easements.
11. Remove landscaping from manhole.

General Comments:

General Items:

- Must meet City 2023 Standards of Design and Construction
- 4% Engineering Inspection Fees
- Minimum easement width is 20' for new easements. No structures including walls allowed in easements.
- Retaining walls 3' and over must be engineered.
- All retaining walls (18" or taller) must be rock or stone face. No smooth concrete walls.
- The property will need to be platted.

Drainage Items:

- No detention is allowed within the 100yr flood plain.
- Drainage calculations based on property zoning, not land area use.
- The property owner will be responsible for maintaining, repair, and replacement of the detention/drainage systems.
- No grate inlets allowed
- Floodplain, erosion hazard setback, and detention ponds must be in a drainage easement with 20' additional easement.
- The existing stream on site is WOTUS.
- Must have a wetlands/WOTUS determination for all streams/creeks on site.
- Must have a flood study for all changes and crossing of the floodplain. Review fees apply.
- Must show and meet erosion hazard setback for all creeks/streams.

- No vertical walls allowed in detention/drainage easement.
- No public water or sanitary sewer allowed in detention/drainage easements.
- 100-year WSEL must be called out for detention ponds, and floodplains a minimum of every 300'.
- FFE for all buildings must be called out when adjacent to floodplain and detention ponds. Minimum 2' above 100-year WSEL.
- Dumpster areas to drain to oil/water separator and then to the storm lines.
- Drainage easement width for storm sewer is minimum 20', or 2 times depth plus width of culvert, raised to the nearest 5 ft.

Water and Wastewater Items:

- Show existing/proposed utility lines (Water, Sewer, etc.)
- Public sewer to be 8" minimum.
- There is an 8" and a 24" sewer main available to this site.
- The existing 24" sewer main and associated easement running through the site might need to be relocated to avoid the proposed building footprint.
- Any water lines must be a minimum of 8", looped, and must be in a 20' wide easement.
- There is an 8" and 12" water main available for this site.
- Only one "use" off a dead-end line (domestic, irrigation, fire sprinkler, fire hydrant, etc.)
- Min 20' utility easements.

Roadway Paving Items:

- Parking to be 20'x9'.
- No dead-end parking allowed without an City approved turnaround.
- Drive isles to be 24' wide.
- Fire lane to have 20' min radius if buildings are less than 30' tall. If any of the buildings are 30' or more, the fire lane will be 30' radius minimum.
- Fire lane to be in a platted easement.

Landscaping:

- No trees to be with 10' of any public water, sewer or storm line that is 10" in diameter or larger.
- No trees to be with 5' of any public water, sewer, or storm line that is less than 10".

Building Inspections Comments:

- Oil/water Separator and Grease Trap are to be sized by an Engineer per the 2021 International Plumbing Code and this information will be required to be provided with the Building Permit
- Signage and Irrigation require separate permits from the Building Permit submittal

Fire Department:

- Review access to existing fire hydrants. It appears that the proposed landscaping and retaining walls will be an obstruction to access.

GIS Department:

- Assigned Address will be: 3003 N. GOLIAD ST, ROCKWALL, TX 75087

Parks Department:

- Common Bermuda is a dated turfgrass variety and there are many other varieties available that very cold, wear, drought tolerant: Tif Tuf, Tahoma 31, Latitude 36, etc. Tif Tuf is one that we have tested and use in Parks and Recreation in Rockwall and main benefits are that it stays green into December, greens up in February and most importantly much less water usage.
- Include landscape plans for the detention and park area.



EAST

TOTAL FACADE	= 1,967.9 SF	100%
-TOTAL GLASS	= 485.0 SF	24.6%
<hr/>		
NET FACADE	= 1,482.9 SF	
TOTAL BRICK/CAST STONE	= 173.2 SF	11.8%
TOTAL NATURAL STONE	= 666.5 SF	44.9%
TOTAL STUCCO	= 554.4 SF	37.4%
TOTAL METAL	= 87.8 SF	5.9%

MATERIAL LEGEND:

- ① STUCCO VENEER ← PLEASE CHANGE STUCCO VENEER TO 3-PART STUCCO.
- ② PROJECTING STUCCO ACCENT BAND
- ③ BRICK VENEER
- ④ MANUFACTURED METAL COPING
- ⑤ PAINTED METAL CANOPY
- ⑥ ALUMINUM STOREFRONT AND ENTRANCES WITH CLEAR INSULATING GLASS
- ⑦ PAINTED HOLLOW METAL DOORS AND FRAMES
- ⑧ CAST STONE ACCENT BAND
- ⑨ LINE OF ROOF DECK WITH HVAC UNITS BEYOND
- ⑩ ALUMINUM DRIVE-UP WINDOW

STAFF WOULD SUGGEST BRINGING THIS BACK APPROX. 3- FEET

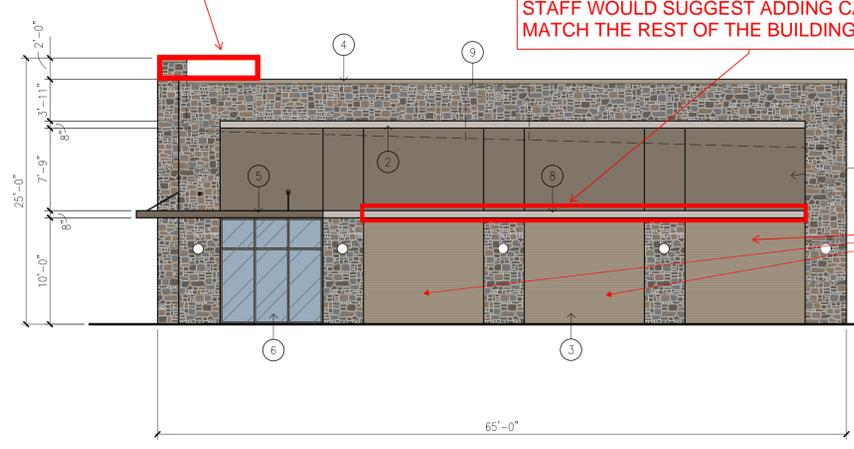

NORTH

TOTAL FACADE	= 1,502.0 SF	100%
-TOTAL GLASS	= 97.0 SF	6.4%
<hr/>		
NET FACADE	= 1,405.0 SF	
TOTAL BRICK/CAST STONE	= 370.3 SF	26.4%
TOTAL NATURAL STONE	= 530.4 SF	37.8%
TOTAL STUCCO	= 464.6 SF	33.1%
TOTAL METAL	= 39.0 SF	2.7%

STAFF WOULD SUGGEST ADDING CANOPIES TO MATCH THE REST OF THE BUILDING

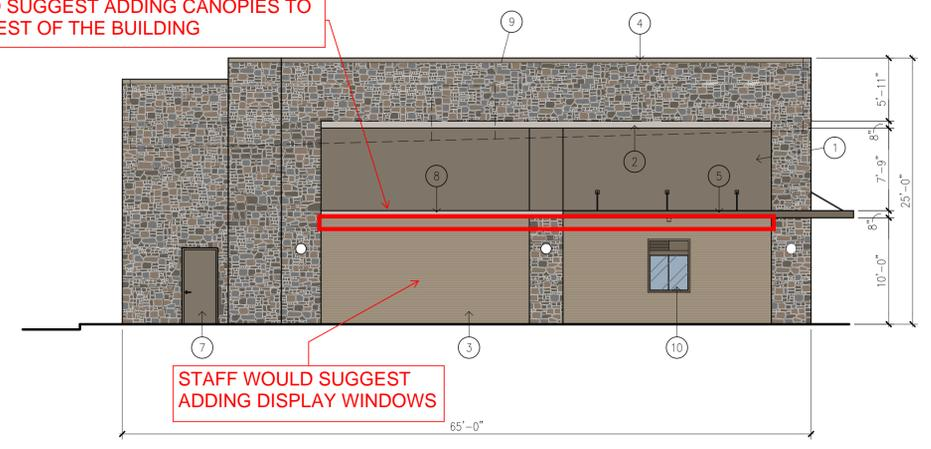

SOUTH

TOTAL FACADE	= 1,606.6 SF	100%
-TOTAL GLASS	= 20.0 SF	1.2%
-TOTAL DOORS	= 24.2 SF	1.5%
<hr/>		
NET FACADE	= 1,562.4 SF	
TOTAL BRICK/CAST STONE	= 388.4 SF	24.8%
TOTAL NATURAL STONE	= 771.7 SF	49.4%
TOTAL STUCCO	= 357.7 SF	22.9%
TOTAL METAL	= 45.3 SF	2.9%

STAFF WOULD SUGGEST ADDING CANOPIES TO MATCH THE REST OF THE BUILDING

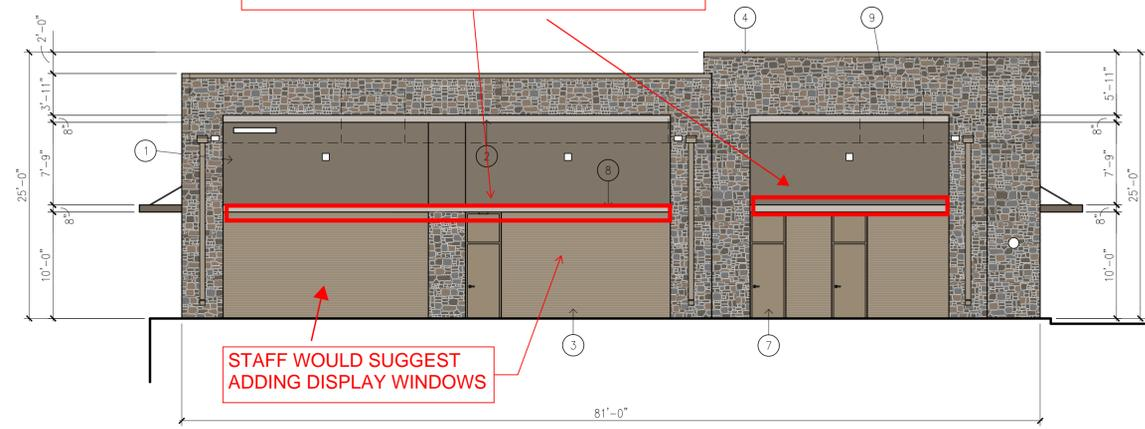

WEST

TOTAL FACADE	= 1,926.5 SF	100%
-TOTAL DOORS	= 101.2 SF	5.2%
<hr/>		
NET FACADE	= 1,825.3 SF	
TOTAL BRICK/CAST STONE	= 514.0 SF	28.2%
TOTAL NATURAL STONE	= 764.2 SF	41.9%
TOTAL STUCCO	= 513.1 SF	28.1%
TOTAL METAL	= 34.0 SF	1.8%

ARCHITECTURAL ELEMENTS:

1. CANOPIES
2. RECESSES / PROJECTIONS
3. OUTDOOR PATIO
4. ARCHITECTURAL DETAILS - CAST STONE ACCENT BAND
5. ARCHITECTURAL DETAILS - PROJECTING STUCCO ACCENT BAND
6. VARIED ROOF HEIGHTS

SITE PLAN SUBMITTAL

REVISION NO:	DATE:
SHEET TITLE:	
BUILDING FACADE / ELEVATION PLAN	
OWNER:	
<small>ARCHITECT:</small> DONALD F. SOPRANZI, AIA, LEED-AP ARCHITECT 10300 NORTH CENTRAL EXPRESSWAY, SUITE 450 DALLAS, TEXAS 75231 DONALD SOPRANZI 817-903-6663 dons@dfsarchitect.com	
SCALE: 1/8"=1'-0"	FILE NO.

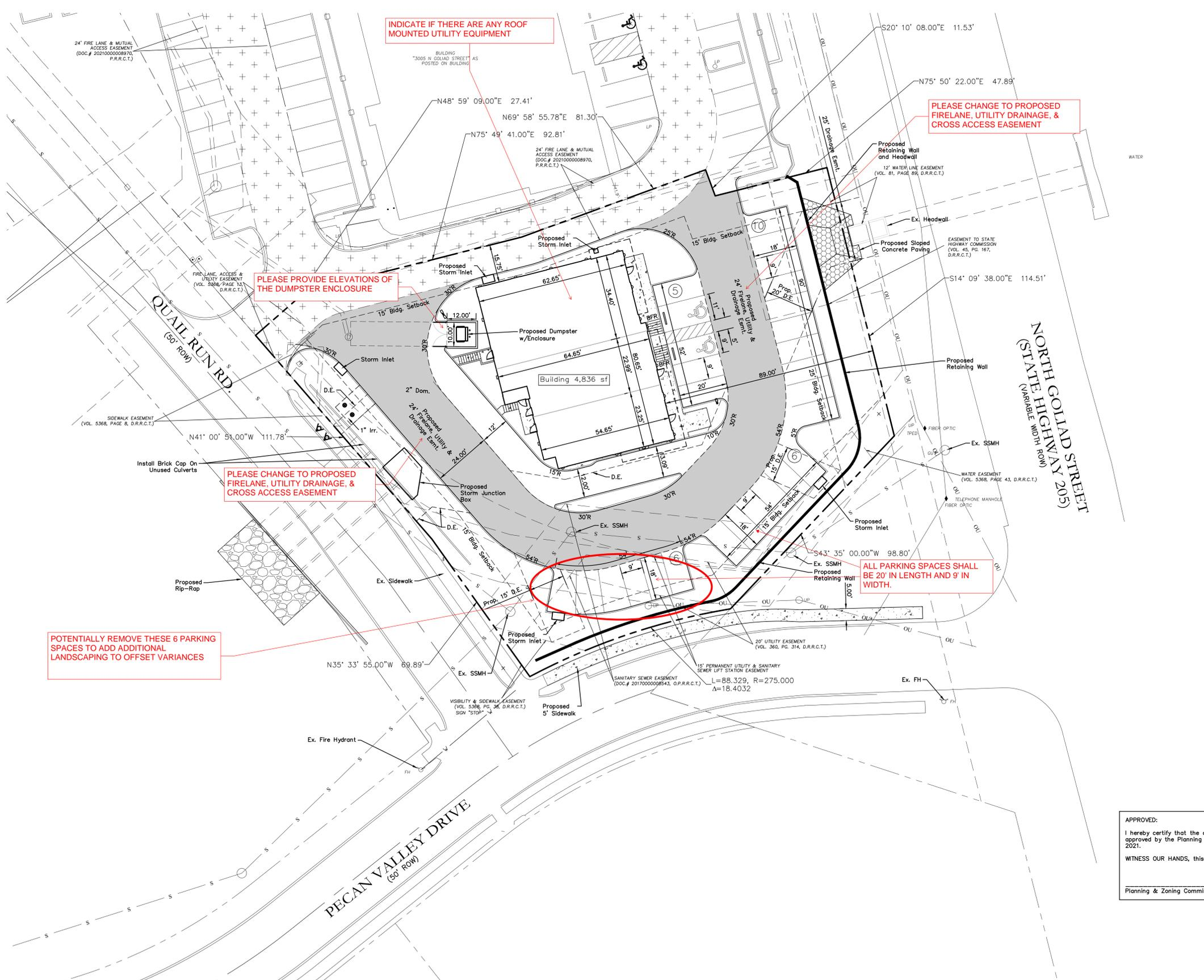

INDICATE IF THERE ARE ANY ROOF MOUNTED UTILITY EQUIPMENT

PLEASE CHANGE TO PROPOSED FIRELANE, UTILITY DRAINAGE, & CROSS ACCESS EASEMENT

PLEASE PROVIDE ELEVATIONS OF THE DUMPSTER ENCLOSURE

PLEASE CHANGE TO PROPOSED FIRELANE, UTILITY DRAINAGE, & CROSS ACCESS EASEMENT

ALL PARKING SPACES SHALL BE 20' IN LENGTH AND 9' IN WIDTH.

POTENTIALLY REMOVE THESE 6 PARKING SPACES TO ADD ADDITIONAL LANDSCAPING TO OFFSET VARIANCES

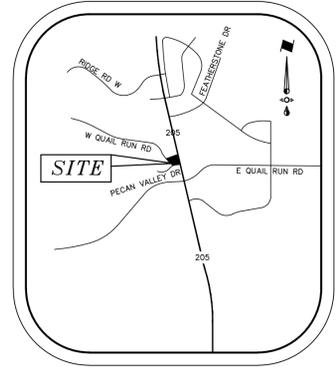

VICINITY MAP
NTS

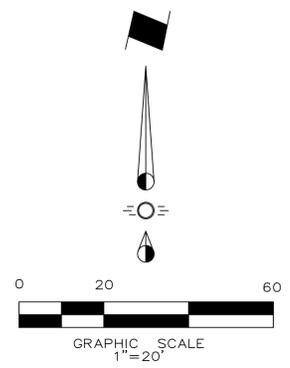

LEGEND

- Existing Firelane
- Proposed Firelane
- Proposed Sidewalk
- Proposed Sloped Concrete Paving
- Proposed Retaining Wall
- Proposed Wheel Stop Typical
- Existing Fire Hydrant
- Proposed Fire Hydrant
- Barrier Free Ramp

SYNOPSIS

Zoning: PD-65 w/ N. SH 205 Overlay
 Proposed Use: Retail/Restaurant
 Lot Area: 0.7621 Acres (33,198 sf)
 Building Areas: Building 4,836 sf
 Lot Coverage: 13.59% (Total Bldg Area 4,512 sf)
 Floor Area Ratio: 0.14 : 1
 Building Height: 25'
 Required Parking: Retail 1:250 (3533/250) = 15 Spcs.
 Restaurant 1:250 (1247/250) = 5 Spcs (Limited Service)

Parking Required Total:	20 Parking Spaces
Parking Provided Total:	27 Parking Spaces (2 HC)

NOTE:
 ALL PARKING PAVING TO BE 5", 3000 PSI CONCRETE.
 ALL FIRELANE PAVING TO BE MIN. 6", 3500 PSI CONCRETE.

APPROVED:
 I hereby certify that the above and foregoing site plan for a development in the City of Rockwall, Texas, was approved by the Planning & Zoning Commission of the City of Rockwall on the _____ day of _____ 2021.
 WITNESS OUR HANDS, this _____ day of _____ 2023.
 Planning & Zoning Commission, Chairman _____ Director of Planning and Zoning _____

Note:
 REFERENCE ARCHITECTURAL PLANS FOR BUILDING DIMENSIONS.

NOTE: THIS IS NOT A CONSTRUCTION DOCUMENT.
 THIS DOCUMENT IS FOR CONCEPTUAL PLANNING PURPOSES ONLY.

ENGINEER:
 Cross Engineering Consultants, Inc.
 1720 W. Virginia Street
 McKinney, Texas 75069
 Phone (972) 562-4409
 Fax (972) 562-4471
 Contact: Jon David Cross, P.E.

SURVEYOR:
 Barton Chapa Surveying
 5200 State Highway 121
 Colleyville, TX. 76034
 Phone (817) 864-1957
 Contact: Jack Barton

OWNER:
 JCDB Goliad Holdings, LLC
 8350 N. Central Expressway
 Dallas, Texas 75206

Issue Dates:	Revision & Date:
1	1
2	2
3	3
4	4
5	5
6	6

CROSS ENGINEERING CONSULTANTS
 1720 W. Virginia Street McKinney, Texas 75069
 972.562.4409 Texas P.E. Firm No. F-5935

Drawn By:	Checked By:	Scale:
C.E.C.I.	C.E.C.I.	1"=20'

SITE PLAN		SP
SMOOTHIE KING ROCKWALL		
DA Goliad Partners, LP CITY OF ROCKWALL, TEXAS		

Project No. 20089

SMOOTHIE KING ROCKWALL

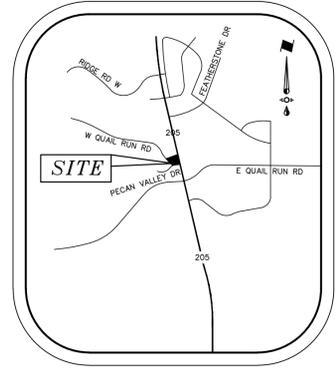
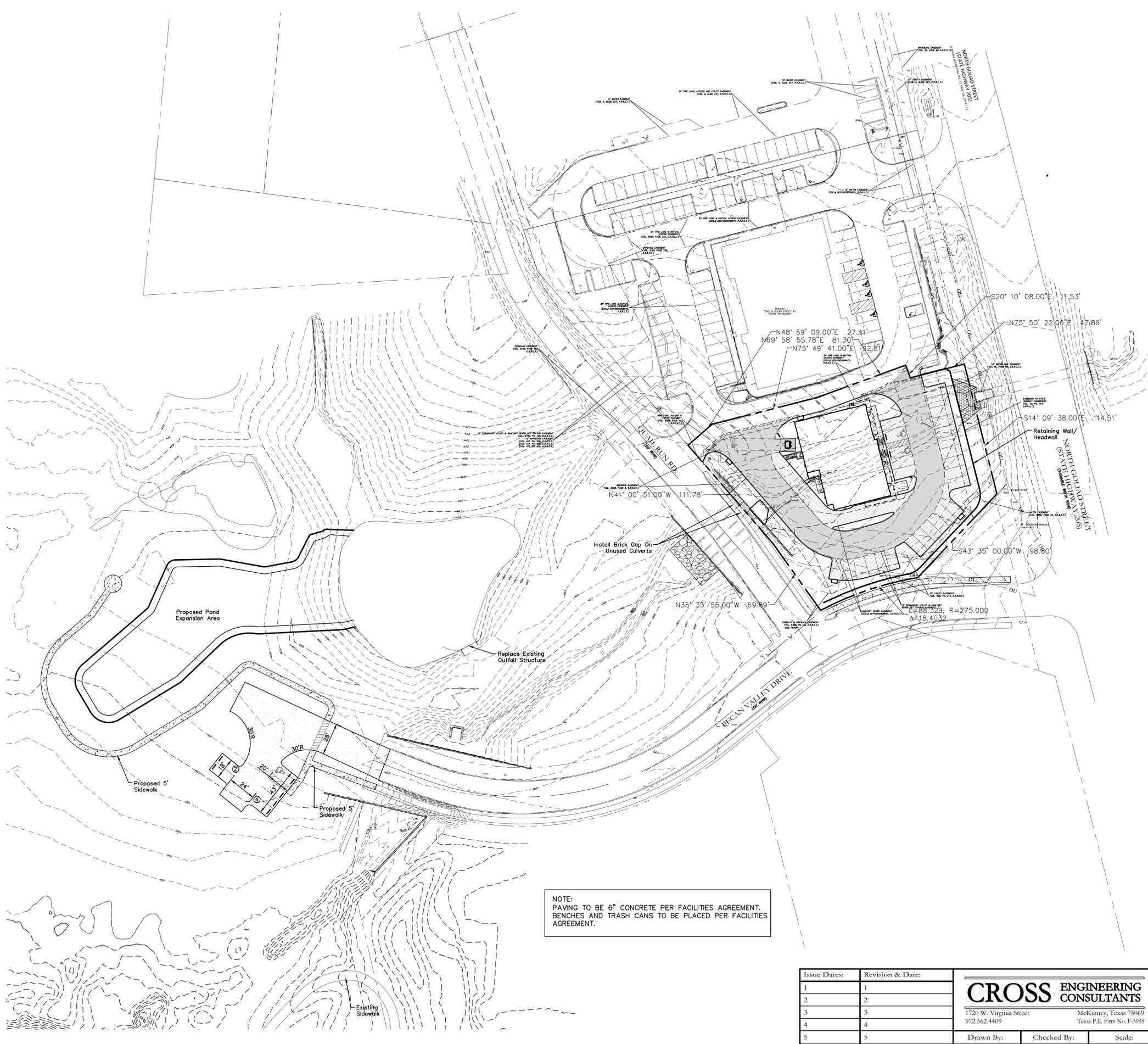

VICINITY MAP
NTS

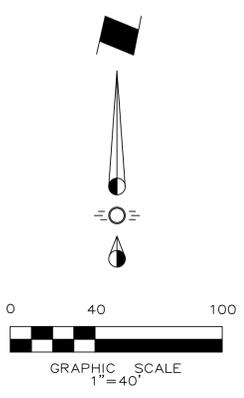

LEGEND

- Proposed Retaining Wall
- Proposed Wheel Stop Typical
- ⊕ Existing Fire Hydrant
- ⊕ Proposed Fire Hydrant
- BFR Barrier Free Ramp

NOTE:
PAVING TO BE 6" CONCRETE PER FACILITIES AGREEMENT.
BENCHES AND TRASH CANS TO BE PLACED PER FACILITIES AGREEMENT.

NOTE: THIS IS NOT A CONSTRUCTION DOCUMENT.
THIS DOCUMENT IS FOR CONCEPTUAL PLANNING PURPOSES ONLY.

Issue Dates:	Revision & Date:
1	1
2	2
3	3
4	4
5	5
6	6

CROSS ENGINEERING CONSULTANTS
 1720 W. Virginia Street McKinney, Texas 75069
 972.562.4409 Texas P.E. Firm No. F-5935

Drawn By: C.E.C.I. Checked By: C.E.C.I. Scale: 1"=40'

SITE PLAN - OVERALL
 SMOOTHIE KING ROCKWALL
 DA Goliad Partners, LP
 CITY OF ROCKWALL, TEXAS

Sheet No.
SP-O

Project No.
20089

SMOOTHIE KING ROCKWALL

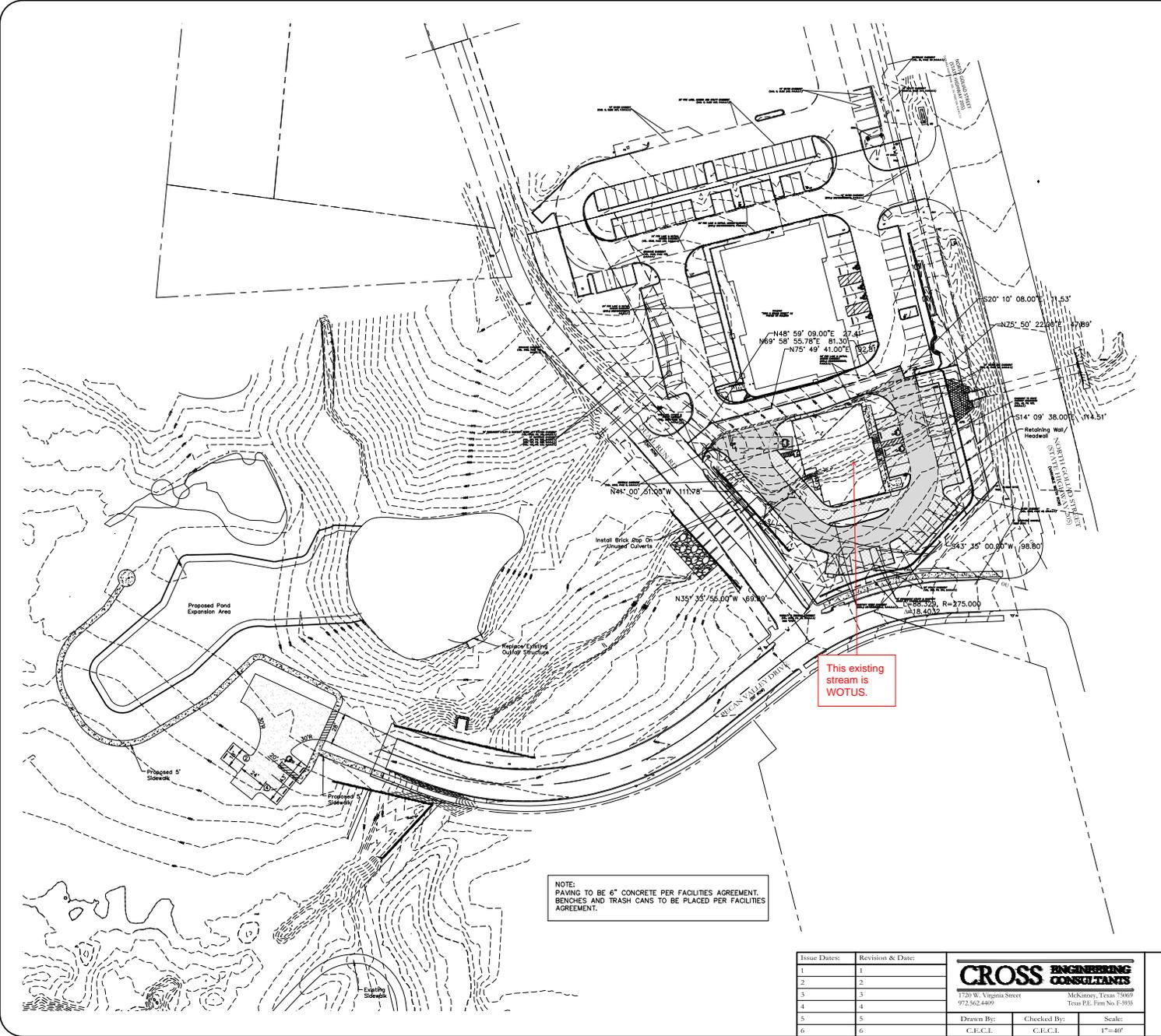

- General Items:**
- Must meet City 2023 Standards of Design and Construction
 - 4% Engineering Inspection Fees
 - Minimum easement width is 20' for new easements. No structures including walls allowed in easements.
 - Retaining walls 3' and over must be engineered.
 - All retaining walls (18" or taller) must be rock or stone face. No smooth concrete walls.
 - The property will need to be platted.
- Drainage Items:**
- No detention is allowed within the 100yr flood plain.
 - Drainage calculations based on property zoning, not land area use.
 - The property owner will be responsible for maintaining, repair, and replacement of the detention/drainage systems.
 - No grate inlets allowed
 - Floodplain, erosion hazard setback, and detention ponds must be in a drainage easement with 20' additional easement.
 - The existing stream on site is WOTUS.
 - Must have a wetlands/WOTUS determination for all streams/creeks on site.
 - Must have a flood study for all changes and crossing of the floodplain. Review fees apply.
 - Must show and meet erosion hazard setback for all creeks/streams.
 - No vertical walls allowed in detention/drainage easement.
 - No public water or sanitary sewer allowed in detention/drainage easements.
 - 100-year WSEL must be called out for detention ponds, and floodplains a minimum of every 300'.
 - FFE for all buildings must be called out when adjacent to floodplain and detention ponds. Minimum 2' above 100-year WSEL.
 - Dumpster areas to drain to oil/water separator and then to the storm lines.
 - Drainage easement width for storm sewer is minimum 20', or 2 times depth plus width of culvert, raised to the nearest 5 ft.
- Water and Wastewater Items:**
- Show existing/proposed utility lines (Water, Sewer, etc.)
 - Public sewer to be 8" minimum.
 - There is an 8" and a 24" sewer main available to this site.
 - The existing 24" sewer main and associated easement running through the site might need to be relocated to avoid the proposed building footprint.
 - Any water lines must be a minimum of 8", looped, and must be in a 20' wide easement.
 - There is an 8" and 12" water main available for this site.
 - Only one "use" off a dead-end line (domestic, irrigation, fire sprinkler, fire hydrant, etc.)
 - Min 20' utility easements.
- Roadway Paving Items:**
- Parking to be 20'x9'.
 - No dead-end parking allowed without an City approved turnaround.
 - Drive isles to be 24' wide.
 - Fire lane to have 20' min radius if buildings are less than 30' tall. If any of the buildings are 30' or more, the fire lane will be 30' radius minimum.
 - Fire lane to be in a platted easement.
- Landscaping:**
- No trees to be with 10' of any public water, sewer or storm line that is 10" in diameter or larger.
 - No trees to be with 5' of any public water, sewer, or storm line that is less than 10".

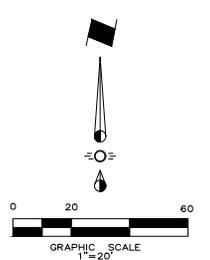
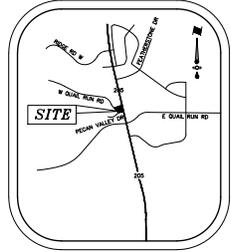
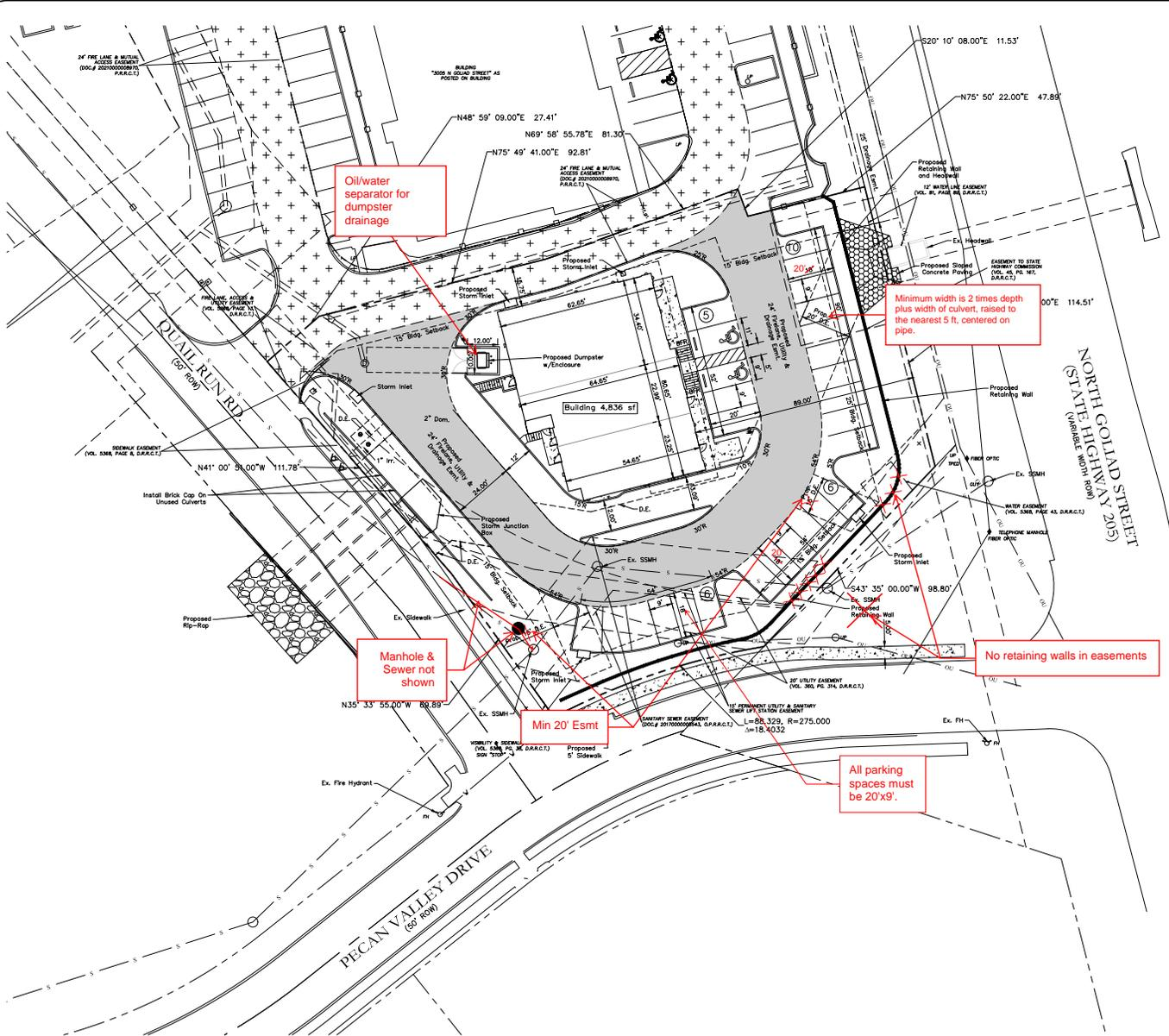

- VICINITY MAP**
NTS
- LEGEND**
- Existing Firelane
 - Proposed Firelane
 - Proposed Sidewalk
 - Proposed Sloped Concrete Paving
 - Proposed Retaining Wall
 - Proposed Wheel Stop Typical
 - Existing Fire Hydrant
 - Proposed Fire Hydrant
 - BFR Barrier Free Ramp

SYNOPSIS

Zoning: PD-65 w/ N. SH 205 Overlay
 Proposed Use: Retail/Restaurant
 Lot Area: 0.7621 Acres (33,198 sf)
 Building Areas: Building 4,836 sf
 Lot Coverage: 13.59% (Total Bldg Area 4,512 sf)
 Floor Area Ratio: 0.14 : 1
 Building Height: 25'

Required Parking: Retail 1:250 (3533/250) = 15 Spcs.
 Restaurant 1:250 (1247/250) = 5 Spcs (Limited Service)

Parking Required Total: 20 Parking Spaces
 Parking Provided Total: 27 Parking Spaces (2 HC)

NOTE:
 ALL PARKING PAVING TO BE 5", 3000 PSI CONCRETE.
 ALL FIRELANE PAVING TO BE MIN. 6", 3500 PSI CONCRETE.

3,600 psi (min 6.5 sack mix)

Min 5.5 sack mix

APPROVED:
 I hereby certify that the above and foregoing site plan for a development in the City of Rockwall, Texas, was approved by the Planning & Zoning Commission of the City of Rockwall on the _____ day of _____, 2021.
 WITNESS OUR HANDS, this _____ day of _____, 2021.

 Planning & Zoning Commission, Chairman

 Director of Planning and Zoning

ENGINEER:
 Cross Engineering Consultants, Inc.
 1720 W. Virginia Street
 McKinney, Texas 75069
 Phone (972) 562-4409
 Fax (972) 562-4471
 Contact: Jon David Cross, P.E.

SURVEYOR:
 Barton Chapp Surveying
 5200 State Highway 121
 Colleyville, TX 76034
 Phone (817) 864-1957
 Contact: Jack Barton

OWNER:
 JCOB Goliad Holdings, LLC
 8350 N. Central Expressway
 Dallas, Texas 75206

Note:
 REFERENCE ARCHITECTURAL PLANS
 FOR BUILDING DIMENSIONS.

NOTE: THIS IS NOT A CONSTRUCTION DOCUMENT.
 THIS DOCUMENT IS FOR CONCEPTUAL PLANNING PURPOSES ONLY. CASE NO. _____

Issue Dates	Revision & Date
1	1
2	2
3	3
4	4
5	5
6	6

CROSS ENGINEERING CONSULTANTS
 1720 W. Virginia Street
 McKinney, Texas 75069
 972.562.4409
 Texas P.E. Firm No. F-9135

Drawn By: _____ Checked By: _____ Scale: _____
 C.E.C.L. C.E.C.L. 1"=20'

SITE PLAN
 SMOOTHIE KING ROCKWALL
 DA Goliad Partners, LP
 CITY OF ROCKWALL, TEXAS

Sheet No.
SP
 Project No.
 200899

SMOOTHIE KING ROCKWALL

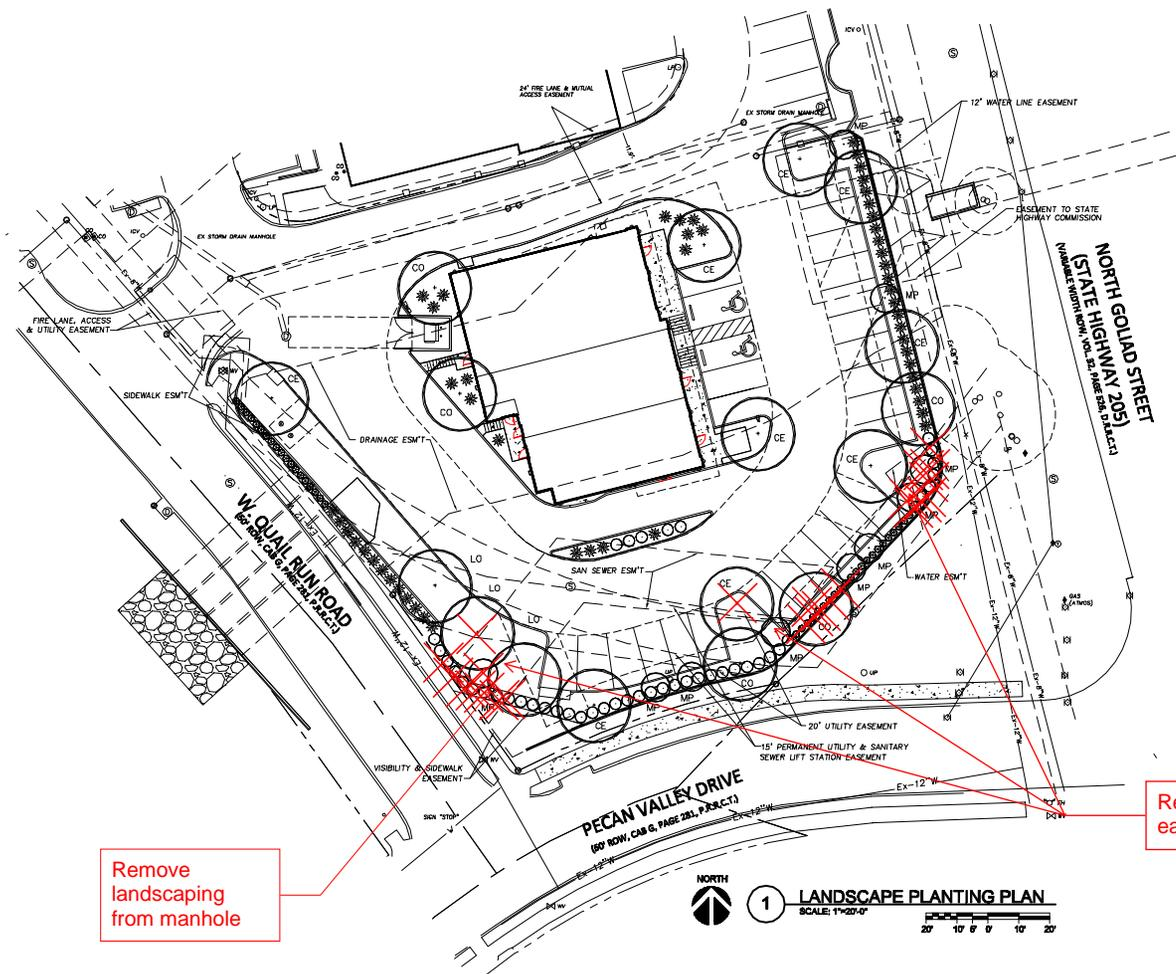

MAINTENANCE NOTE:

THE OWNER, TENANT AND THEIR AGENT, IF ANY, SHALL BE JOINTLY AND SEVERALLY RESPONSIBLE FOR THE MAINTENANCE OR ALL LANDSCAPING. ALL REQUIRED LANDSCAPING SHALL BE MAINTAINED IN A NEAT AND ORDERLY MANNER AT ALL TIMES. THIS SHALL INCLUDE, BUT NOT BE LIMITED TO: MOWING (OF TURF GRASS SIX (6") INCHES OR HIGHER), EDGING, PRUNING, FERTILIZING, WATERING, WEEDING, AND OTHER SUCH ACTIVITIES COMMON TO THE MAINTENANCE OF LANDSCAPING. LANDSCAPED AREAS SHALL BE KEPT FREE OF ALL TRASH, LITTER, WEEDS, AND OTHER SUCH MATERIALS OR PLANTS THAT ARE NOT A PART OF THE LANDSCAPING. ALL PLANT MATERIALS SHALL BE MAINTAINED IN A HEALTHY AND GROWING CONDITION AS IS APPROPRIATE FOR THE SEASON OF THE YEAR. PLANT MATERIALS WHICH DIE SHALL BE REPLACED WITH PLANT MATERIAL OF SIMILAR SIZE, WITHIN NINETY (90) DAYS. TREES WITH A TRUNK DIAMETER IN EXCESS OF SIX (6") INCHES MEASURED TWENTY-FOUR (24") INCHES ABOVE THE GROUND MAY BE REPLACED WITH ONES THAT HAVE BEEN PRE-APPROVED (2") SIMILAR VARIETY, HAVING A TRUNK DIAMETER OF NO LESS THAN THREE (3") INCHES MEASURED TWENTY-FOUR (24") INCHES ABOVE THE GROUND. A TIME EXTENSION MAY BE GRANTED BY CITY STAFF IF SUBSTANTIAL EVIDENCE IS PRESENTED TO INDICATE ABNORMAL CIRCUMSTANCES BEYOND THE CONTROL OF THE OWNER OR HIS AGENT.

LANDSCAPE NOTES:

- ALL LANDSCAPE REQUIREMENTS AND IRRIGATION SYSTEM WILL CONFORM TO THE LOCAL CITY ORDINANCE AND DESIGN STANDARDS AND ANY REQUIREMENTS OF THE STATE, IF APPLICABLE.
- NO PLANT MATERIAL SHALL BE PLANTED UNTIL THE LANDSCAPE IRRIGATION SYSTEM HAS BEEN INSTALLED AND IS OPERATING WITH 100% COVERAGE OF PROPOSED LANDSCAPE AREAS.
- THE LANDSCAPE CONTRACTOR SHALL BE RESPONSIBLE FOR MAKING HIMSELF FAMILIAR WITH ALL UNDERGROUND UTILITIES, PIPES, CABLES, STRUCTURES AND LANE RULES.
- THE CONTRACTOR IS RESPONSIBLE FOR VERIFICATION OF ALL QUANTITIES BASED ON THE DRAWINGS AND ACTUAL FIELD DIMENSIONS. PLANT QUANTITIES HAVE BEEN PROVIDED AS A CONVENIENCE ONLY TO THE OWNER(S) AND SHALL NOT BE CONSIDERED ABSOLUTE. CONTRACTOR SHALL FOLLOW DESIGN INTENT.
- NOTIFY THE OWNER OF ANY DISCREPANCIES THAT ARISE DURING THE CONSTRUCTION. FAILURE TO NOTIFY, SUCH DISCREPANCIES KNOWN TO OWNER WILL RESULT IN THE CONTRACTOR'S LIABILITY TO REDO WORK AS NECESSARY TO ACHIEVE THE DESIGN INTENT.
- PROTECT EXISTING VEGETATION, EQUIPMENT, STRUCTURES, UTILITIES, AND OTHER IMPROVEMENTS AT THE PROJECT SITE AND ON ADJACENT PROPERTIES, EXCEPT THOSE INDICATED TO BE REMOVED OR ALTERED. ALL AREAS DISTURBED BY DEMOLITION AND CONSTRUCTION ACTIVITIES SHALL BE REPAIRED AND RESTORED TO THEIR PRE-CONSTRUCTION CONDITION INCLUDING: PAVEMENTS, LANDSCAPE AREAS, IRRIGATION AND LIGHTING.
- PROVIDE MEASURES AS REQUIRED TO PREVENT EROSION AND DISCHARGE OF SOIL-BEARING RUNOFF AND AIRBORNE DUST TO UNDISTURBED AREAS AND ADJACENT PROPERTIES, SIDEWALKS, STREETS, AND OTHER PAVED SURFACES.
- ALL PROPOSED SUBSTITUTIONS MUST BE APPROVED BY THE LANDSCAPE ARCHITECT PRIOR TO INSTALLATION.
- NOTIFY THE LANDSCAPE ARCHITECT IF LAYOUT OF TREES, BEDS AND/OR PLANTS REQUIRE ALTERATION FROM THE LANDSCAPE PLAN. NOTIFICATION WILL BE REQUIRED PRIOR TO ALTERING THE LAYOUT.
- TREES SHALL BE HANDLED BY ROOT BALLS ONLY. DO NOT DAMAGE BALL, TRUNK, OR LOGGED TRUNK. FROM HILL TRUNKS ARE TO BE PLANTED STRAIGHT AND MAY BE REQUIRED BY THE OWNER AND/OR THE LANDSCAPE ARCHITECT TO BE STAKED.
- WHEN NEWLY PLANTED TREES ARE NOT ABLE TO STAND ON THEIR OWN, TREES SHALL BE STAKED WITH AN AT-GRADE ROOT BALL SECURING SYSTEM. THE SYSTEM SHALL SECURELY ANCHOR THE ROOT BALL, ALLOWING THE TRUNK AND CROWN TO MOVE NATURALLY. THE SYSTEM SHALL NOT USE MATERIALS AND METHODS THAT PENETRATE OR DAMAGE THE ROOT BALL ABOVE GRADE. STAKING SYSTEMS SUCH AS TIE POSTS WITH WIRES, HOSES, STRAPS, OR GUY WIRES WRAPPED AROUND THE TREE TRUNK SHALL NOT BE ALLOWED UNLESS AUTHORIZED BY THE LANDSCAPE ARCHITECT.
- ALL TREES TO BE UNIFORM BY SPECIES WITH STRAIGHT TRUNKS AND MATCHING CHARACTER AND BRANCHING STRUCTURE.
- ALL TREE LOCATIONS SHALL BE APPROVED BY THE OWNER OR OWNER'S REPRESENTATIVE PRIOR TO PLANTING.
- FINAL LOCATIONS OF PLANT MATERIAL IS SUBJECT FOR REVIEW AND APPROVAL BY OWNER PRIOR TO PLANTING.
- PROVIDE POSITIVE DRAINAGE THROUGHOUT THE PROJECT AREA, NO PONDING OR STANDING WATER IS ACCEPTABLE.
- CONTRACTOR SHALL PROVIDE A MINIMUM 2% SLOPE AWAY FROM ALL BUILDINGS.
- AT NO TIME WILL ANY PLANT MATERIAL BE ALLOWED TO SETTLE BEYOND THE TOP OF THE ROOT FLARE OR POTTED SOIL LINE. SHOULD PLANT MATERIAL SETTLE, THE PLANTED AREA WILL BE REPAIRED TO ORIGINAL HEIGHT AND/OR REPLACED IF NECESSARY AT THE CONTRACTOR'S COST.
- ALL PROPOSED BED AREAS SHALL BE FILLED TO A DEPTH OF SIX INCHES (6"), ADDING A THREE INCH (3") MINIMUM LAYER OF BRINDING CORREKT DURING THE PROCESS. THE LEVEL OF THE BED AREAS SHOULD BE LEFT THREE INCHES (3") ABOVE THE PROPOSED FINISHED GRADE TO ALLOW FOR COMPACTION AND SETTLEMENT.
- ALL BED AREAS SHALL BE SEPARATED FROM TURF AREAS USING 1/2" X 4" STEEL EDGING. PAINTED GREEN. ALL TREE WELLS SHALL HAVE A RADIUS OF 45 DEGREE ANGLE TO ELIMINATE SHARP EDGES. HAND FINISH MAY BE REQUIRED TO ACHIEVE A SMOOTH EDGE.
- TRIM STEEL EDGING AT A 45 DEGREE ANGLE WHEN EDGING INTERSECTS WITH A WALK OR CURB. DO NOT INSTALL EDGING ALONG CURBS OR WALKS.
- ALL LANDSCAPE BEDS SHALL RECEIVE A TWO INCH (2") TOP DRESS LAYER OF HARDWOOD MULCH AND ALL TREE WELLS SHALL RECEIVE A THREE INCH (3") LAYER OF SHREDED HARDWOOD MULCH. DO NOT COVER ROOT FLARE.
- TOP OF MULCH SHALL BE 1/2" MINIMUM BELOW THE TOP OF WALKS AND CURBS.
- TURF AREAS SHALL BE CLEAN OF DEBRIS AND RAKED (GRADED) SMOOTH PRIOR TO HYDROSEEDING. PRIOR TO SEEDING, LANDSCAPE CONTRACTOR TO RECEIVE GRADE WITHIN APPROX. 1/8" OF FINAL GRADE.
- OWNER RESPONSIBLE TO PROVIDE ELECTRICAL SERVICE FOR THE IRRIGATION SYSTEM. WHICH INCLUDES A HARDWARE OF 110 VOLTS AT MINIMUM FOR THE CONTROLLER.
- ALL LANDSCAPING LOCATED WITHIN THE VISIBILITY TRIANGLES SHALL COMPLY WITH THE VISIBILITY TRIANGLE REQUIREMENTS AS PER THE CITY STANDARDS.
- ALL LIGHT POLES MAY NOT BE SHOWN ON THE PROJECT SITE OR ADJACENT PROPERTIES. IF A PROPOSED TREE IS IN CONFLICT WITH ANY LIGHT OR UTILITY POLE, THE CONTRACTOR SHALL CONTACT THE LANDSCAPE ARCHITECT, TO DETERMINE OPTIONS, PRIOR TO PLANTING.
- PLANTS AND TREES ARE TO CONFORM TO AMERICAN ASSOCIATION OF NURSERYMEN AND TEXAS ASSOCIATION OF NURSERYMEN STANDARDS.
- THE LANDSCAPE ARCHITECT RESERVES THE RIGHT TO REFUSE ANY LANDSCAPE MATERIAL ON SITE.

LANDSCAPE CALCULATIONS

ZONING - COMM (20%) LANDSCAPE AREA REQUIRED.
 LOT AREA = 32,676 SF
 20% = 6,535 SF
 LANDSCAPE AREA PROVIDED = 9,308 SF = 28.4% WITH 7,513 SF = IN FRONT YARD.
 LANDSCAPE BUFFER AT STREET R.O.W. = 10' WITH 1-CANOPY TREE & 1-ACCENT TREE/50' AND A ROW OF SHRUBS.
 GUAL RUN = 180' 180'/50' = 4+4
 PECAN VALLEY = 185' 185'/50' = 4+4
 N. GOLIAD ST. = 110' 110'/50' = 2+2
 10 CANOPY TREES REQUIRED. 10-PROVIDED.
 10 ACCENT TREES REQUIRED. 10-PROVIDED.
 118 SHRUBS PROVIDED.
 INTERIOR PARKING LOT LANDSCAPING: 4,374 SF PARKING LOT AREA 1,120 SF LANDSCAPE AREA PROVIDED = 25%
 NOTES:
 ALL TREES MUST BE PLANTED AT LEAST FIVE (5) FEET FROM WATER, SEWER AND STORM LINES.
 IRRIGATION SYSTEM WILL MEET REQUIREMENTS OF UDC.

Remove all trees from easements

Remove landscaping from manhole

LANDSCAPE PLANTING PLAN
 SCALE: 1"=20'-0"
 NORTH

PLANT MATERIAL SCHEDULE

KEY	QTY	COMMON NAME	BOTANICAL NAME	SPECIFICATIONS
CANOPY TREES				
CE	9	CEDAR ELM	Ulmus crassifolia	5" cal. 12'-14" tall, b&b.
CO	5	CHINQUAPIN OAK	Quercus muhlenbergi	5" cal. 12'-14" tall, b&b.
LO	3	LIVE OAK	Quercus virginiana	5" cal. 12'-14" tall, b&b.
ORNAMENTAL TREES				
MP	10	MEXICAN PLUM	Prunus mexicana	2" cal., 6'-8" tall, container
SHRUBS				
CTS	45	COMPACT TEXAS SAGE	Leucophyllum frutescens "Compacta"	5 gallon, 48" on center.
RM	41	ROSEMARY	Rosemary officinalis	5 gallon, 30" on center.
RY	54	RED YUCCA	Hesperaloe parviflora	5 gallon, 48" on center.
GROUND COVER				
FW	-	PURPLE WINTERCREPER	Euonymus fortunei "Coloratus"	1 gallon, 18" on center.
TURF GRASS				
BC	-	BERMUDA GRASS	Cynodon dactylon	solid sod

<table border="1"> <thead> <tr> <th>REVISION</th> <th>NO.</th> <th>DATE</th> </tr> </thead> <tbody> <tr> <td> </td> <td> </td> <td> </td> </tr> </tbody> </table>	REVISION	NO.	DATE				<p>Don C. Wheeler Landscape Architect Landscape Architecture Planning Subordinate Design P.O. Box 470865 Dallas 917.335.1405 Fort Worth, Texas 76147 don@dcwla.com</p>		<p>LANDSCAPE PLAN SMOOTHIE KING ROCKWALL DA Goliad Partners, L.P. CITY OF ROCKWALL, TEXAS</p>	<p>Sheet No. L1</p>
REVISION	NO.	DATE								
<p>APPROVED: I hereby certify that the above and foregoing site plan for a development in the City of Rockwall, Texas, was approved by the Planning & Zoning Commission of the City of Rockwall on the _____ day of _____, 2023. WITNESS OUR HANDS, this _____ day of _____, 2023.</p>		<p>Planning & Zoning Commission, Chairman Director of Planning and Zoning</p>		<p>PLAN PREPARED BY: DON C. WHEELER, RLA P.O. BOX 470865 FT. WORTH, TX 76147 917.335.1405 don@dcwla.com</p>						
<p>PROJECT NO. 24023-48 DATE 12-15-2023</p>		<p>DATE 12/15/23</p>								



DEVELOPMENT APPLICATION

City of Rockwall
Planning and Zoning Department
385 S. Goliad Street
Rockwall, Texas 75087

STAFF USE ONLY

PLANNING & ZONING CASE NO.

NOTE: THE APPLICATION IS NOT CONSIDERED ACCEPTED BY THE CITY UNTIL THE PLANNING DIRECTOR AND CITY ENGINEER HAVE SIGNED BELOW.

DIRECTOR OF PLANNING:

CITY ENGINEER:

PLEASE CHECK THE APPROPRIATE BOX BELOW TO INDICATE THE TYPE OF DEVELOPMENT REQUEST [SELECT ONLY ONE BOX]:

PLATTING APPLICATION FEES:

- MASTER PLAT (\$100.00 + \$15.00 ACRE)¹
- PRELIMINARY PLAT (\$200.00 + \$15.00 ACRE)¹
- FINAL PLAT (\$300.00 + \$20.00 ACRE)¹
- REPLAT (\$300.00 + \$20.00 ACRE)¹
- AMENDING OR MINOR PLAT (\$150.00)
- PLAT REINSTATEMENT REQUEST (\$100.00)

SITE PLAN APPLICATION FEES:

- SITE PLAN (\$250.00 + \$20.00 ACRE)¹
- AMENDED SITE PLAN/ELEVATIONS/LANDSCAPING PLAN (\$100.00)

ZONING APPLICATION FEES:

- ZONING CHANGE (\$200.00 + \$15.00 ACRE)¹
- SPECIFIC USE PERMIT (\$200.00 + \$15.00 ACRE)^{1 & 2}
- PD DEVELOPMENT PLANS (\$200.00 + \$15.00 ACRE)¹

OTHER APPLICATION FEES:

- TREE REMOVAL (\$75.00)
- VARIANCE REQUEST/SPECIAL EXCEPTIONS (\$100.00)²

NOTES:

¹: IN DETERMINING THE FEE, PLEASE USE THE EXACT ACREAGE WHEN MULTIPLYING BY THE PER ACRE AMOUNT FOR REQUESTS ON LESS THAN ONE ACRE, ROUND UP TO ONE (1) ACRE.
²: A \$1,000.00 FEE WILL BE ADDED TO THE APPLICATION FEE FOR ANY REQUEST THAT INVOLVES CONSTRUCTION WITHOUT OR NOT IN COMPLIANCE TO AN APPROVED BUILDING PERMIT

PROPERTY INFORMATION [PLEASE PRINT]

ADDRESS 150 Pecan Valley Drive
 SUBDIVISION Pecan Valley Retail LOT 3 BLOCK A
 GENERAL LOCATION NW corner of Pecan Valley Drive and SH 205

ZONING, SITE PLAN AND PLATTING INFORMATION [PLEASE PRINT]

CURRENT ZONING PD-65 CURRENT USE Vacant
 PROPOSED ZONING PD-65 PROPOSED USE Retail/Restaurant
 ACREAGE 0.7621 LOTS [CURRENT] 1 LOTS [PROPOSED] 1

SITE PLANS AND PLATS: BY CHECKING THIS BOX YOU ACKNOWLEDGE THAT DUE TO THE PASSAGE OF HB3167 THE CITY NO LONGER HAS FLEXIBILITY WITH REGARD TO ITS APPROVAL PROCESS, AND FAILURE TO ADDRESS ANY OF STAFF'S COMMENTS BY THE DATE PROVIDED ON THE DEVELOPMENT CALENDAR WILL RESULT IN THE DENIAL OF YOUR CASE.

OWNER/APPLICANT/AGENT INFORMATION [PLEASE PRINT/CHECK THE PRIMARY CONTACT/ORIGINAL SIGNATURES ARE REQUIRED]

<input type="checkbox"/> OWNER	JCDB Goliad Holdings, LLC	<input checked="" type="checkbox"/> APPLICANT	Cross Engineering Consultants, Inc.
CONTACT PERSON	Chad Dubose	CONTACT PERSON	Dwayne Zinn
ADDRESS	8350 N. Central Expressway Suite 1300	ADDRESS	1720 W. Virginia St.
CITY, STATE & ZIP	Dallas, TX 75206	CITY, STATE & ZIP	McKinney, TX 75069
PHONE	214-561-6522	PHONE	972-562-4409
E-MAIL	chad@foremark.com	E-MAIL	Dwayne@crossengineering.biz

NOTARY VERIFICATION [REQUIRED]

BEFORE ME, THE UNDERSIGNED AUTHORITY, ON THIS DAY PERSONALLY APPEARED Chad Dubose [OWNER] THE UNDERSIGNED, WHO STATED THE INFORMATION ON THIS APPLICATION TO BE TRUE AND CERTIFIED THE FOLLOWING:

I HEREBY CERTIFY THAT I AM THE OWNER FOR THE PURPOSE OF THIS APPLICATION; ALL INFORMATION SUBMITTED HEREIN IS TRUE AND CORRECT; AND THE APPLICATION FEE OF \$ 215.00 TO COVER THE COST OF THIS APPLICATION, HAS BEEN PAID TO THE CITY OF ROCKWALL ON THIS THE 12th DAY OF December, 2023. BY SIGNING THIS APPLICATION, I AGREE THAT THE CITY OF ROCKWALL (I.E. "CITY") IS AUTHORIZED AND PERMITTED TO PROVIDE INFORMATION CONTAINED WITHIN THIS APPLICATION TO THE PUBLIC. THE CITY IS ALSO AUTHORIZED AND PERMITTED TO REPRODUCE ANY COPYRIGHTED INFORMATION SUBMITTED IN CONJUNCTION WITH THIS APPLICATION, IF SUCH REPRODUCTION IS ASSOCIATED OR IN RESPONSE TO A REQUEST FOR PUBLIC INFORMATION.

GIVEN UNDER MY HAND AND SEAL OF OFFICE ON THIS THE 12 DAY OF December 20, 2023

OWNER'S SIGNATURE

Chad Dubose

NOTARY PUBLIC IN AND FOR THE STATE OF TEXAS

Lisa Marie Butler

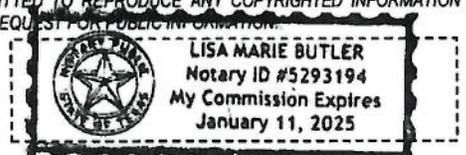

MY COMMISSION EXPIRES

1/11/25



SP2023-049: Site Plan for Retail Building (Smoothie King)

AG
0 30 60 120 180 240 Feet

SF-10

PD-70

PD-65

PD-5

Case Location Map = 



City of Rockwall

Planning & Zoning Department
385 S. Goliad Street
Rockwall, Texas 75087
(P): (972) 771-7745
(W): www.rockwall.com

The City of Rockwall GIS maps are continually under development and therefore subject to change without notice. While we endeavor to provide timely and accurate information, we make no guarantees. The City of Rockwall makes no warranty, express or implied, including warranties of merchantability and fitness for a particular purpose. Use of the information is the sole responsibility of the user.



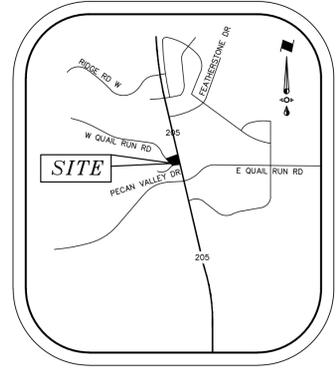
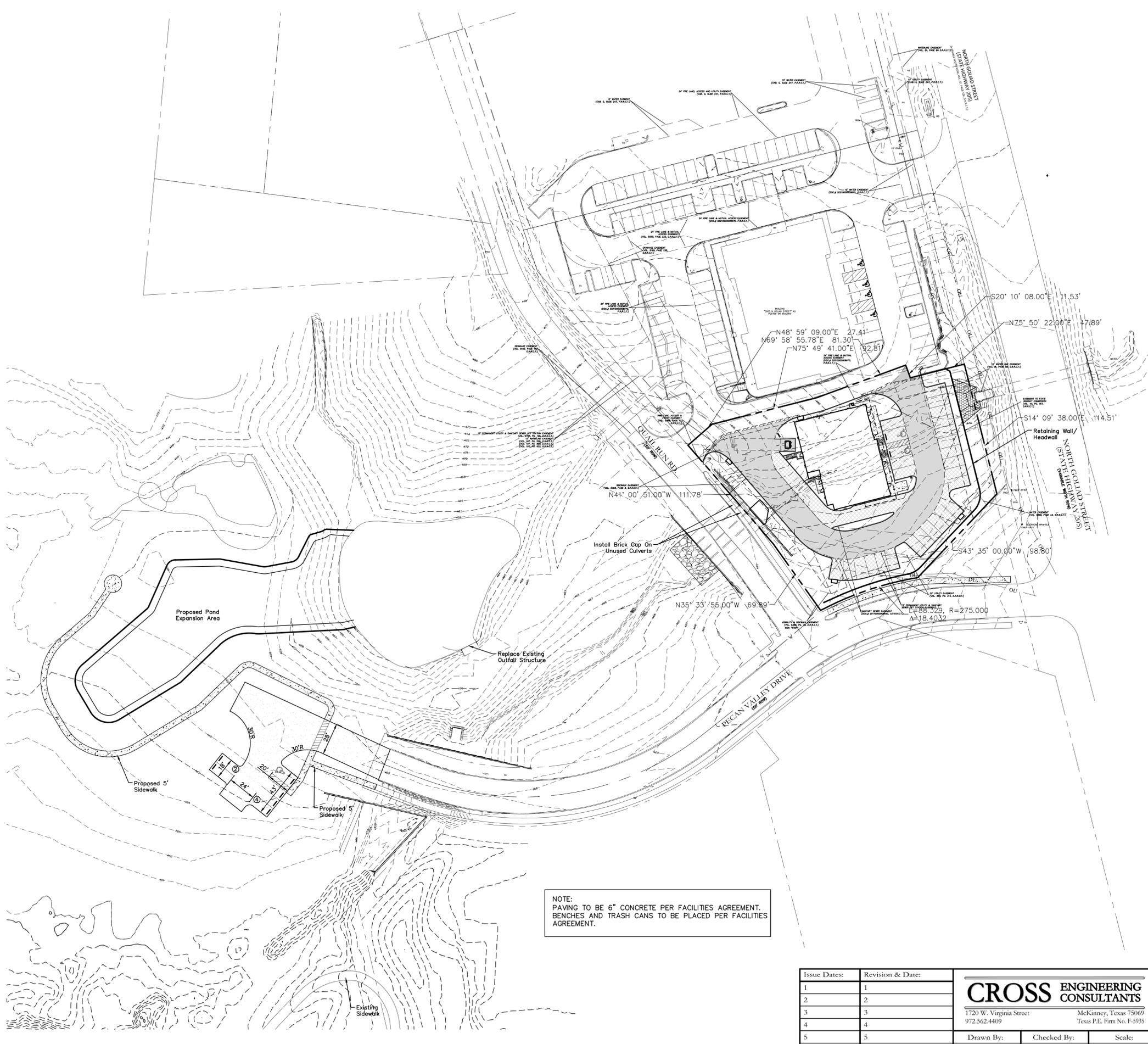

VICINITY MAP
NTS

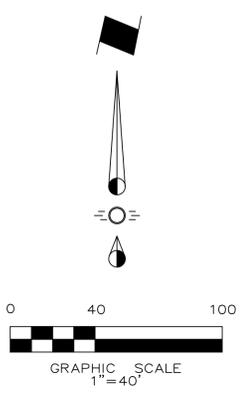

LEGEND

- Proposed Retaining Wall
- Proposed Wheel Stop Typical
- ⊕ Existing Fire Hydrant
- ⊕ Proposed Fire Hydrant
- BFR Barrier Free Ramp

NOTE:
PAVING TO BE 6" CONCRETE PER FACILITIES AGREEMENT.
BENCHES AND TRASH CANS TO BE PLACED PER FACILITIES AGREEMENT.

NOTE: THIS IS NOT A CONSTRUCTION DOCUMENT.
THIS DOCUMENT IS FOR CONCEPTUAL PLANNING PURPOSES ONLY.

Issue Dates:	Revision & Date:
1	1
2	2
3	3
4	4
5	5
6	6

CROSS ENGINEERING CONSULTANTS
 1720 W. Virginia Street McKinney, Texas 75069
 972.562.4409 Texas P.E. Firm No. F-5935

Drawn By: C.E.C.I. Checked By: C.E.C.I. Scale: 1"=40'

SITE PLAN - OVERALL

SMOOTHIE KING ROCKWALL

DA Goliad Partners, LP

CITY OF ROCKWALL, TEXAS

Sheet No.
SP-O

Project No.
20089

SMOOTHIE KING ROCKWALL

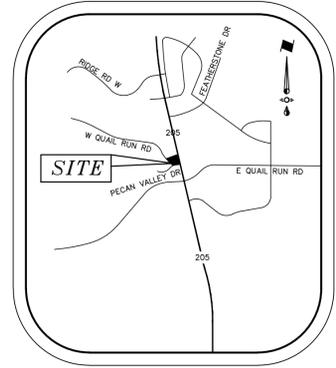
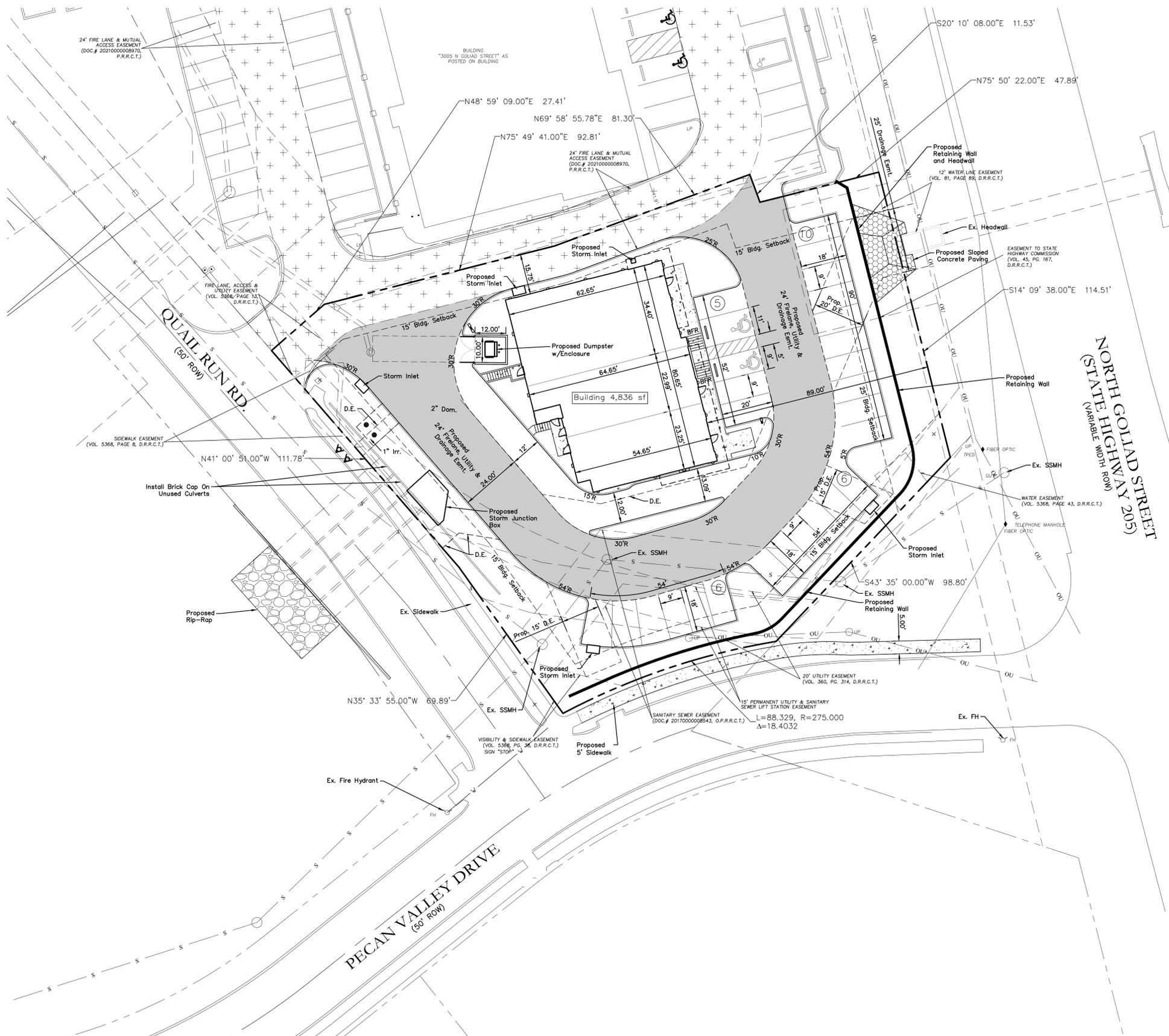

VICINITY MAP
NTS

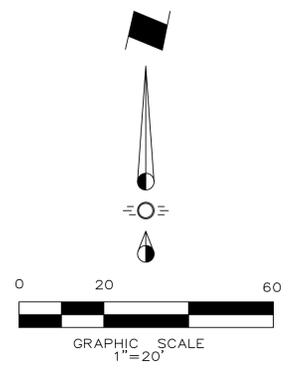

LEGEND

- Existing Firelane
- Proposed Firelane
- Proposed Sidewalk
- Proposed Sloped Concrete Paving
- Proposed Retaining Wall
- Proposed Wheel Stop Typical
- Existing Fire Hydrant
- Proposed Fire Hydrant
- Barrier Free Ramp

SYNOPSIS

Zoning: PD-65 w/ N. SH 205 Overlay
 Proposed Use: Retail/Restaurant
 Lot Area: 0.7621 Acres (33,198 sf)
 Building Areas: Building 4,836 sf
 Lot Coverage: 13.59% (Total Bldg Area 4,512 sf)
 Floor Area Ratio: 0.14 : 1
 Building Height: 25'
 Required Parking: Retail 1:250 (3533/250) = 15 Spcs.
 Restaurant 1:250 (1247/250) = 5 Spcs (Limited Service)

Parking Required Total:	20 Parking Spaces
Parking Provided Total:	27 Parking Spaces (2 HC)

NOTE:
 ALL PARKING PAVING TO BE 5", 3000 PSI CONCRETE.
 ALL FIRELANE PAVING TO BE MIN. 6", 3500 PSI CONCRETE.

APPROVED:
 I hereby certify that the above and foregoing site plan for a development in the City of Rockwall, Texas, was approved by the Planning & Zoning Commission of the City of Rockwall on the _____ day of _____ 2021.
 WITNESS OUR HANDS, this _____ day of _____ 2023.
 Planning & Zoning Commission, Chairman _____ Director of Planning and Zoning _____

Note:
 REFERENCE ARCHITECTURAL PLANS FOR BUILDING DIMENSIONS.

NOTE: THIS IS NOT A CONSTRUCTION DOCUMENT.
 THIS DOCUMENT IS FOR CONCEPTUAL PLANNING PURPOSES ONLY. CASE NO. _____

ENGINEER:
 Cross Engineering Consultants, Inc.
 1720 W. Virginia Street
 McKinney, Texas 75069
 Phone (972) 562-4409
 Fax (972) 562-4471
 Contact: Jon David Cross, P.E.

SURVEYOR:
 Barton Chapa Surveying
 5200 State Highway 121
 Colleyville, TX. 76034
 Phone (817) 864-1957
 Contact: Jack Barton

OWNER:
 JCDB Goliad Holdings, LLC
 8350 N. Central Expressway
 Dallas, Texas 75206

Issue Dates:	Revision & Date:
1	1
2	2
3	3
4	4
5	5
6	6

CROSS ENGINEERING CONSULTANTS
 1720 W. Virginia Street McKinney, Texas 75069
 972.562.4409 Texas P.E. Firm No. F-5935

Drawn By: C.E.C.I.	Checked By: C.E.C.I.	Scale: 1"=20'
--------------------	----------------------	---------------

SITE PLAN		SP
SMOOTHIE KING ROCKWALL		
DA Goliad Partners, LP CITY OF ROCKWALL, TEXAS		
		Project No. 20089

SMOOTHIE KING ROCKWALL



EAST

TOTAL FACADE	= 1,967.9 SF	100%
-TOTAL GLASS	= 485.0 SF	24.6%
<hr/>		
NET FACADE	= 1,482.9 SF	
TOTAL BRICK/CAST STONE	= 173.2 SF	11.8%
TOTAL NATURAL STONE	= 666.5 SF	44.9%
TOTAL STUCCO	= 554.4 SF	37.4%
TOTAL METAL	= 87.8 SF	5.9%

MATERIAL LEGEND:

- ① STUCCO VENEER
- ② PROJECTING STUCCO ACCENT BAND
- ③ BRICK VENEER
- ④ MANUFACTURED METAL COPING
- ⑤ PAINTED METAL CANOPY
- ⑥ ALUMINUM STOREFRONT AND ENTRANCES WITH CLEAR INSULATING GLASS
- ⑦ PAINTED HOLLOW METAL DOORS AND FRAMES
- ⑧ CAST STONE ACCENT BAND
- ⑨ LINE OF ROOF DECK WITH HVAC UNITS BEYOND
- ⑩ ALUMINUM DRIVE-UP WINDOW

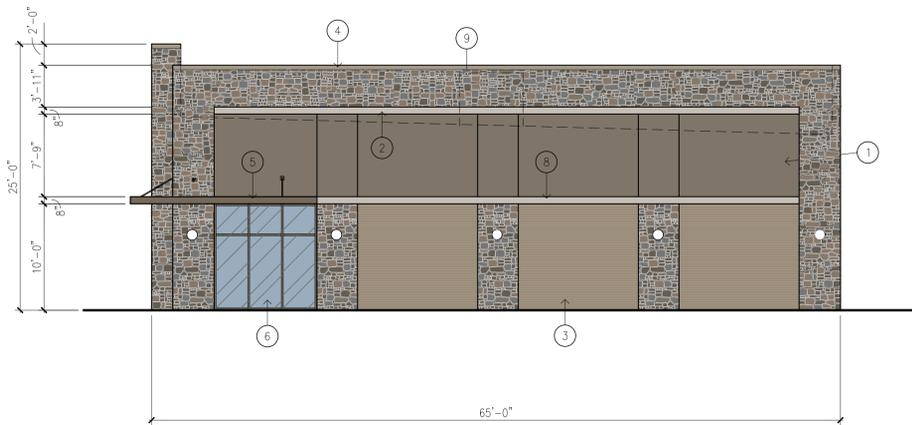

NORTH

TOTAL FACADE	= 1,502.0 SF	100%
-TOTAL GLASS	= 97.0 SF	6.4%
<hr/>		
NET FACADE	= 1,405.0 SF	
TOTAL BRICK/CAST STONE	= 370.3 SF	26.4%
TOTAL NATURAL STONE	= 530.4 SF	37.8%
TOTAL STUCCO	= 464.6 SF	33.1%
TOTAL METAL	= 39.0 SF	2.7%

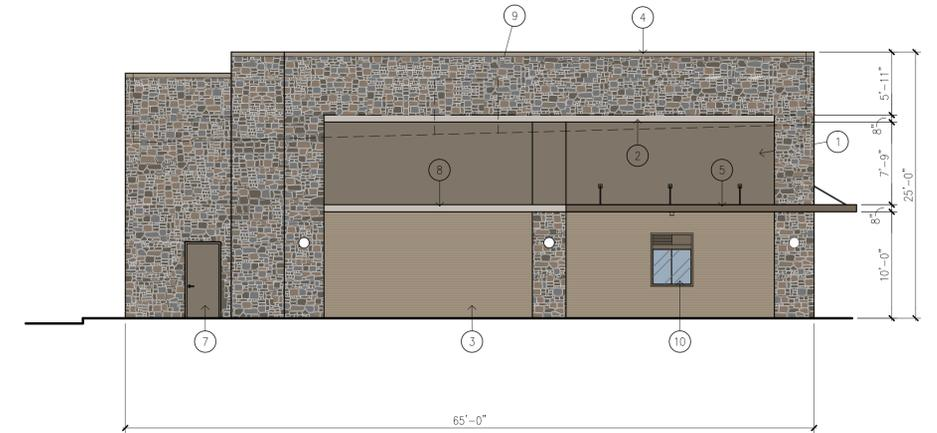

SOUTH

TOTAL FACADE	= 1,606.6 SF	100%
-TOTAL GLASS	= 20.0 SF	1.2%
-TOTAL DOORS	= 24.2 SF	1.5%
<hr/>		
NET FACADE	= 1,562.4 SF	
TOTAL BRICK/CAST STONE	= 388.4 SF	24.8%
TOTAL NATURAL STONE	= 771.7 SF	49.4%
TOTAL STUCCO	= 357.7 SF	22.9%
TOTAL METAL	= 45.3 SF	2.9%

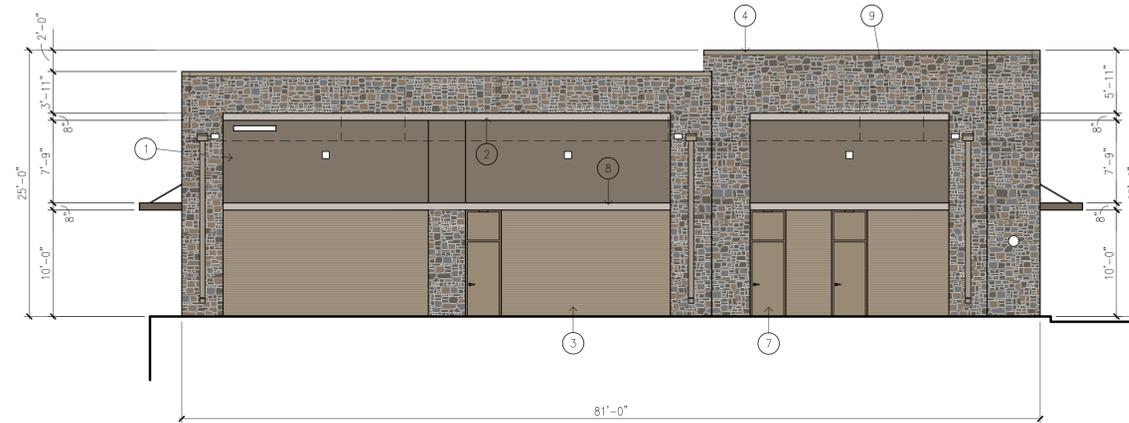

WEST

TOTAL FACADE	= 1,926.5 SF	100%
-TOTAL DOORS	= 101.2 SF	5.2%
<hr/>		
NET FACADE	= 1,825.3 SF	
TOTAL BRICK/CAST STONE	= 514.0 SF	28.2%
TOTAL NATURAL STONE	= 764.2 SF	41.9%
TOTAL STUCCO	= 513.1 SF	28.1%
TOTAL METAL	= 34.0 SF	1.8%

ARCHITECTURAL ELEMENTS:

- 1. CANOPIES
- 2. RECESSES / PROJECTIONS
- 3. OUTDOOR PATIO
- 4. ARCHITECTURAL DETAILS - CAST STONE ACCENT BAND
- 5. ARCHITECTURAL DETAILS - PROJECTING STUCCO ACCENT BAND
- 6. VARIED ROOF HEIGHTS

SITE PLAN SUBMITTAL

REVISION NO:	DATE:
SHEET TITLE:	
BUILDING FACADE / ELEVATION PLAN	
OWNER:	
<small>ARCHITECT:</small> DONALD F. SOPRANZI, AIA, LEED-AP ARCHITECT 10300 NORTH CENTRAL EXPRESSWAY, SUITE 450 DALLAS, TEXAS 75231 DONALD SOPRANZI 817-903-6663 dons@dfsarchitect.com	
SCALE: 1/8"=1'-0"	FILE NO.

STUCCO VENEER TO MATCH
ADJACENT BUILDING

STUCCO
ACCENT
BAND

CAST
STONE

PARAPET COPINGS /
DOWNSPOUTS



BRICK VENEER

ROCKWALL MULTI-TENANT BUILDING ROCKWALL, TEXAS

STONE VENEER TO MATCH
ADJACENT BUILDING

STOREFRONT
FRAMING /
CANOPIES TO
MATCH
ADJACENT
BUILDING

ROCKWALL, TEXAS
ARCHITECT

ROCKWALL MULTI-TENANT BUILDING
DONALD F. SOPRANZI, AIA, LEED-AP
ARCHITECT

DONALD F.
SOPRANZI
AIA, LEED-AP
ARCHITECT



TREE LEGEND

- EXISTING TREES (8) - (parkway tree)
- EXISTING TREES (NOT PROTECTED) TO BE REMOVED BUT NOT MITIGATED.
- 6" CHINABERRY - NOT PROTECTED
27" BOIS D'ARC - NOT PROTECTED
- EXISTING TREES (PROTECTED) TO BE REMOVED BUT NOT MITIGATED.-UTILITY CONFLICT

- TOTAL NOT PROTECTED - 33"

- EXISTING PROTECTED TREES TO BE REMOVED AND MITIGATED.

2561	22" PECAN
2562	16" PECAN
2563	24" PECAN
2596	8" PECAN
2599	24" PECAN
2714	17" PECAN
2806	40" ELM (MT)

- TOTAL PROTECTED TO MITIGATE - 191"

- 17-NEW 5" TREES PLANTED = 85"

(9) CEDAR ELM	'CE'
(5) CHINQUAPIN OAK	'CO'
(3) LIVE OAK	'LO'

- (10) MEXICAN PLUM 'MP'

EXISTING TREE SCHEDULE

NUMBER	SIZE & TYPE	STATUS
2561	22" PECAN	MITIGATE
2562	16" PECAN	MITIGATE
2563	24" PECAN	MITIGATE
2596	8" PECAN	MITIGATE
2597	24" PECAN	UTILITY
2598	20" PECAN	UTILITY
2599	24" PECAN	MITIGATE
2655	6" CHINABERRY	NOT PROTECTED
2656	9" CHINABERRY (MT)	OFF PROPERTY
2676	5" CHINABERRY	OFF PROPERTY
2677	15" CHINABERRY (MT)	OFF PROPERTY
2701	19" PECAN	OFF PROPERTY
2707	24" PECAN	OFF PROPERTY
2708	16" PECAN	OFF PROPERTY
2709	24" PECAN	OFF PROPERTY
2710	7" PECAN	OFF PROPERTY
2714	17" PECAN	MITIGATE
2716	27" BOIS D'ARC (MT)	NOT PROTECTED
2750	12" ELM	UTILITY
2751	16" ELM	UTILITY
2752	16" ELM	UTILITY
2753	16" ELM	UTILITY
2806	40" ELM (MT)	MITIGATE 2:1
2834	48" ELM	UTILITY

(7) PROTECTED TREES TO MITIGATE- TOTAL = 191 INCHES
 (17) 5" NEW TREES TO PLANT- TOTAL = 85 INCHES
 106 INCHES

106" x 20% = 21" x \$200 = \$4,200 PAID INTO TREE FUND.

REMAINING INCHES TO MITIGATE = 85

Course	Bearing	Distance
L 1	N 35°33'55" W	69.89'
L 2	N 18°54'05" W	37.43'

Curve	Radius	Length	Delta	Chord	Chord Bear.
C 1	275.00'	88.33'	18°24'13"	87.95'	S 71°24'38" W

REVISION	No.	DATE

Don C. Wheeler
 Landscape Architect
 Landscape Architecture Planning Irrigation Design
 P.O. Box 470865 Fort Worth, Texas 76147
 Office 817.335.1405 don@dcwla.com

PROJECT NO. 2K22-45 DATE: 12-15-2023



TREE PLAN

SMOOTHIE KING ROCKWALL

DA Goliad Partners, L.P.

CITY OF ROCKWALL, TEXAS

Sheet No. **TP1**

TREE SURVEY BY:
 STOVALL & ASSOCIATES
 P.O. BOX 202
 GREENVILLE, TEXAS 75403
 PHONE (903) 450-1120
 info@stovallassociates.com
 SEPT. 24, 2015

PLAN PREPARED BY:
 DON C. WHEELER, RLA
 PO BOX 470865
 FT. WORTH, TX 76147
 817.335.1405
 don@dcwla.com

GENERAL NOTES

-THIS CALCULATION IS BASED ON AN OPEN AREA. OBJECTS AND OBSTRUCTIONS WITHIN THIS AREA WILL AFFECT FINAL LIGHTING LEVELS.
 -THE CALCULATED FOOTCANDLE LEVELS INDICATE LUMINAIRE PERFORMANCE BASED ON THE INFORMATION PROVIDED TO TEXAS LIGHTING SOLUTIONS, INC. WE MAKE NO CLAIMS OF COMPLIANCE WITH ANY LOCAL OR STATE LIGHTING CODES.
 -CALCULATIONS ARE PROVIDED USING INDUSTRY RECOGNIZED SOFTWARE AND ARE PROVIDED FOR ESTIMATION PURPOSES ONLY. INPUT DATA FOR THE CALCULATIONS CORRESPONDS TO THE INFORMATION PROVIDED TO US. ASSUMPTIONS MAY BE MADE FOR INFORMATION THAT IS NOT PROVIDED. IT IS THE RESPONSIBILITY OF THOSE USING THIS SERVICE TO VERIFY OUR INPUT DATA IS CONSISTENT WITH EXPECTED FIELD CONDITIONS. RESULTS OF THE LIGHTING CALCULATIONS ACCURATELY REFLECT THE INPUT DATA. HOWEVER, ACTUAL LIGHTING LEVELS WILL VARY DEPENDING ON FIELD CONDITIONS SUCH AS ROOM CHARACTERISTICS, TEMPERATURE, VOLTAGE AND LAMP/BALLAST OUTPUT AND OTHER FACTORS. CALCULATIONS ARE ALSO SUBJECT TO THE LIMITATIONS OF THE SOFTWARE. DUE TO THE ABOVE CONSIDERATIONS, TEXAS LIGHTING SOLUTIONS CANNOT GUARANTEE THAT ACTUAL LIGHT LEVELS MEASURED IN THE FIELD WILL MATCH OUR INITIAL CALCULATIONS.



TEXAS LIGHTING SOLUTIONS

831 WEST EULESS BLVD, SUITE 15
 EULESS, TEXAS 76040
 TEL: 817-267-9300
 CLIENT: TLS CONSULTANT: Shad Campbell

Rockwall Multi-Tenant Building

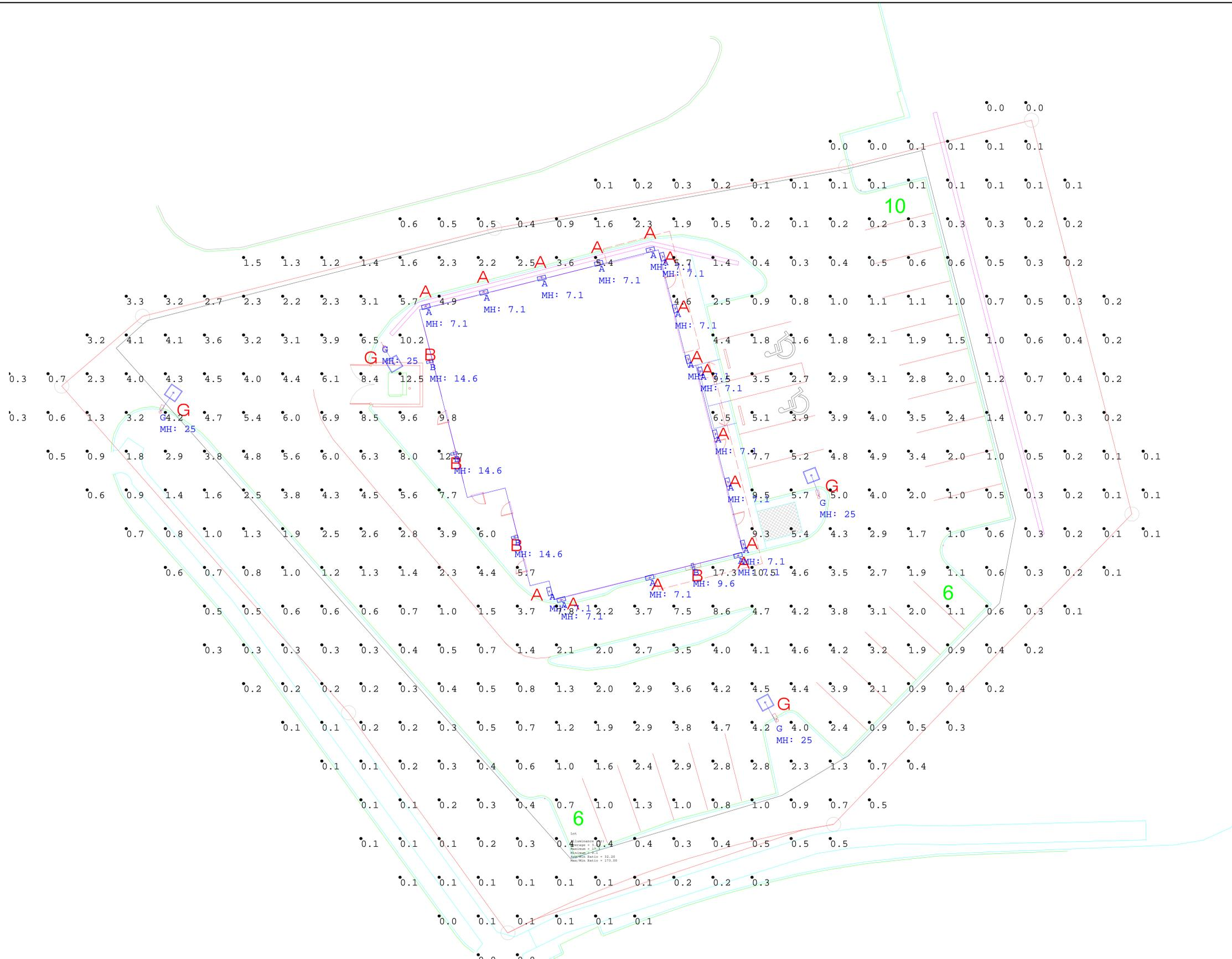

Symbol	Qty	Label	LLF	Description	Lum. Watts	Lumens/Lamp	Lum. Lumens
A	16	A	0.900	UGI-31641-T4-W40	25	N.A.	820
B	4	B	0.900	XTOR4B-DP	37.7	N.A.	4269
G	4	G	0.900	GALN-SA3C-740-U-T3	160	N.A.	20812

Label	CalcType	Units	Avg	Max	Min	Avg/Min	Max/Min
Overall	Illuminance	Fc	2.07	17.3	0.0	N.A.	N.A.
Lot	Illuminance	Fc	3.22	17.3	0.1	32.20	173.00

PHOTOMETRIC PLAN
 SCALE: 1" = 10'-0"

NO.	REVISION	DATE

SCALE: SHEET SIZE 30" X 42"
 JOB NAME:

JOB LOCATION:

SP2023-050: Site Plan for Tharp Industrial Park

Please address the following comments (*M= Mandatory Comments; I = Informational Comments*)

- I.1 This is a request for the approval of a Site Plan for *Office/Warehouse Buildings* on a 3.90-acre tract of land identified as Tracts 2-23 & 2-24 of the J. R. Johnson Survey, Abstract No. 128, City of Rockwall, Rockwall County, Texas, zoned Heavy Commercial (HC) District, located at the southeast corner of the intersection of Mims Road and National Drive.
- I.2 For questions or comments concerning this case please contact Henry Lee in the Planning Department at (972) 772-6434 or email hlee@rockwall.com.
- M.3 For reference, include the case number (*SP2023-050*) in the lower right-hand corner of all pages of all revised plan submittals. (*Subsection 01.02(D), Article 11, Unified Development Code [UDC]*)
- I.4 The subject property will be required to be Final Plat, to establish any new lot lines and new easements.
- M.5 Provide the standard signature block with signature space for the Planning and Zoning Chairman and the Planning Director on all pages of the plans. Also remove the red placeholder text from the signature block. (*Subsection 03.04. A, of Article 11, UDC*)

APPROVED:

I hereby certify that the above and foregoing site plan for a development in the City of Rockwall, Texas, was approved by the Planning & Zoning Commission of the City of Rockwall on the ____ day of _____, ____.

WITNESS OUR HANDS, this ____ day of _____, _____.

Planning & Zoning Commission, Chairman

Director of Planning and Zoning

M.6 Site Plan:

- (1) Within a Heavy Commercial (HC) District the minimum separation between buildings without a fire rated wall is 15-feet. Please update the plans to reflect this, or indicate that the walls will be fire rated to meet the Fire Department's code requirements. (*Subsection 03.04. B, of Article 11, UDC*)
- (2) Please only delineate the building setbacks that are adjacent right-of-way (*i.e. Mims Road and National Drive*). In a Heavy Commercial (HC) District the building setback along a roadway is 25-feet. (*Subsection 03.04. B, of Article 11, UDC*)
- (3) Please indicate the fire lane as Fire Lane, Public Access, and Utility Easement. (*Subsection 03.04. B, of Article 11, UDC*)
- (4) Please provide the office and warehouse square footages for the existing building. Staff needs this in order to calculate total parking. (*Table 5, Article 06, UDC*)
- (5) The proposed parking is deficient for the proposed land uses. Office is 1/300 SF for a total of 60 spaces; warehouse is 1/1,000 SF for a total of 59 spaces; the mezzanines are 1/1,000 SF in this case, for a total of 9 spaces; then the additional parking from the existing building. Given this there must be 128 parking spaces plus what is required for the existing building. (*Table 5, Article 06, UDC*)
- (6) Please indicate the type and depth of paving material and provide a detail or cut-sheet. (*Subsection 03.02, of Article 06, UDC*)
- (7) Is there any existing fence? If so, please indicate the location, height, material, and if it is to remain. Please indicate any new fencing or gates. Please indicate the height, material, and a detail. (*Subsection 08.02. F, of Article 08, UDC*)
- (8) Please indicate the location of any ground mounted utility equipment on the site plan. These must be screened with 5-gallon evergreen shrubs. (*Subsection 01.05. C, of Article 05, UDC*)
- (9) Will there be any roof mounted utility equipment? If so, it must be indicated on the building elevations. (*Subsection 01.05. C, of Article 05, UDC*)
- (10) Please indicate that there will be no above ground storage tanks. (*Subsection 01.05. D, of Article 05, UDC*)
- (11) Dumpsters shall not face onto roadways. Please correct this. (*Subsection 01.05. B, of Article 05, UDC*)
- (12) Please provide a dumpster detail that meets these requirements. Trash/Recycling enclosures shall be four (4) sided. These receptacles shall be screened by a minimum six (6) foot, solid masonry dumpster enclosure that utilizes the same masonry materials as the primary building and incorporates an opaque, self-latching gate. Dumpster storage should be located to the rear of the buildings with proper access. Trash dumpster shall not be located in any required parking space and shall allow proper access by service trucks. The minimum enclosure area shall be 12'x10'. A minimum of 6" bollards

will be required at potential impact zones and the pad site shall be paved to city standards. The enclosure must have 5-gallon evergreen shrubs planted around it. (*Subsection 01.05. B, of Article 05, UDC*)

- (13) The information on the site plan indicates that there is outside storage. This area must be delineated on the site plan. In addition, it must be properly screened to meet our code standards. Either a masonry wall 1-foot taller than what is stored, or three (3) tiered landscape screening. Please delineate the outside storage and the subsequent screening. (*Subsection 01.05, of Article 05, UDC*)

M.7 Landscape Plan:

- (1) Provide the same site data information required in Section 2.1 Site Plan: Miscellaneous and Density and Dimensional Requirements of the development checklist. (*Section 03, of Article 09, UDC*)
- (2) Please provide a landscape table showing plant materials, quantities, size and spacing for existing and proposed landscaping. Complete description of plant materials shown on the plan, including names, locations, qualities, container or caliper sizes at installation, heights, spread, and spacing requirements should also be listed on the plan. (*Subsection 05.03. B, of Article 08, UDC*)
- (3) Please delineate the landscape buffers along Mims Road and National Drive. (*Subsection 05.01, of Article 08, UDC*)
- (4) All parking spaces must be within 80-feet of a canopy tree. (*Subsection 05.03. E, of Article 08, UDC*)
- (5) Please indicate the visibility triangles on all driveways that intersect with a public street. (*Subsection 01.08, of Article 05, UDC*)
- (6) The landscape buffer must include a berm, one (1) canopy and one (1) accent tree per 50-feet of frontage (*i.e. there needs to be 14 canopy and accent trees along National Drive; there needs to be 5 canopy and accent trees along Mims Road*), and a row of shrubs. (*Subsection 05.01, of Article 08, UDC*)
- (7) Please provide note indicating irrigation will meet requirements of UDC. (*Subsection 05.04, of Article 08, UDC*)
- (8) There shall be not paving within the landscape buffers. (*Subsection 05.03. G, of Article 08, UDC*)

M.8 Treescape Plan:

- (1) A Treescape plan is required. Please provide staff with one. (*Subsection 03.04, of Article 11, UDC*)

M.9 Photometric Plan:

- (1) A Photometric plan is required if any lighting is proposed on site. (*Subsection 03.04, of Article 11, UDC*)

M.10 Building Elevations:

- (1) Please provide building elevations for each building. (*Subsection 03.04, of Article 11, UDC*)
- (2) Please indicate the surface area (square feet) of each façade and the percentage and square footage of each material used on that façade (*Subsection 04.01, of Article 05, UDC*)
- (3) If a metal roof is to be used then standing seam must be utilized. In addition, the minimum roof pitch is 6:12. (*Subsection 04.01, of Article 05, UDC*)
- (4) The proposed buildings do not incorporate vertical or horizontal articulation into either the primary or secondary façades. This will be an Exception. (*Subsection 04.01. C. 1, of Article 05, UDC*)

I.11 Staff has identified the following exception(s) associated with the proposed request: [1] primary and secondary articulation, and [2] roof pitch. Should you decide to request these items as variance(s)/exception(s), please provide a letter that lists the variance(s)/exception(s), why they are being requested, and the subsequent compensatory measures. For each variance/exception requested the UDC requires two (2) compensatory measures (*Subsection 09.01, of Article 11*). Examples of compensatory measures include the increased use of masonry material or stone, increased articulation, increased architectural elements, more pedestrian amenity, larger landscape planting sizes, etc.

I.12 Please note that failure to address all comments provided by staff by 3:00 PM on January 3, 2024 will result in the automatic denial of the case on the grounds of an incomplete submittal. No refund will be given for cases that are denied due to an incomplete submittal, and a new application and fee will be required to resubmit the case.

I.13 Staff has identified the aforementioned items necessary to continue the submittal process. Please make these revisions and corrections, and provide any additional information that is requested. Revisions for this case will be due on January 3, 2024; however, it is encouraged for applicants to submit revisions as soon as possible to give staff ample time to review the case prior to the January 9, 2024 Planning & Zoning Meeting.

I.14 Please note the scheduled meetings for this case:

- 1) Planning & Zoning Work Session meeting will be held on December 27, 2023.
- 2) Planning & Zoning meeting/public hearing meeting will be held on January 9, 2024.

- I.15 If the Planning and Zoning Commission approves this site plan case, the applicant will be responsible for submitting hard copies of the final site plan submittal package -- *with all comments addressed* -- for signatures from the Planning and Zoning Commission Chairman and Director of Planning and Zoning. Please note that this will be required to be completed prior to the acceptance of civil engineering plans.
- I.16 All meetings will be held in person and in the City's Council Chambers. All meetings listed above are scheduled to begin at 6:00 p.m. (P&Z). The City prefers that a representative(s) be present for these meetings. During the upcoming work session meeting with the Planning and Zoning Commission, representative(s) are expected to present their case and answer any questions the Planning Commission may have regarding this request.

ENGINEERING COMMENTS:

1. You will need to connect to the existing sewer main via a proposed manhole.
2. Crossings of Mims must be by bore.
3. Sanitary sewer main manholes should not be placed in the flow line of the bar ditch.
4. You will need to provide proposed culverts for these driveways along this drainage ditch.
5. All OH utilities will need to be moved underground.
6. You will need to provide proposed culverts for these driveways along this drainage ditch.
7. Water mains and fire hydrants are required to be centered within a 20' utility easement.
8. You will need to provide tree mitigation for all removed trees on site.
9. Please show/label all landscape buffers and building setback lines. Ensure the dumpster enclosure is not within the building setback.
10. All dumpster enclosures shall have an oil/water separator.
11. No structures within easements, including dumpsters.

General Comments:

General Items:

- Must meet City 2023 Standards of Design and Construction
- 4% Engineering Inspection Fees
- Minimum easement width is 20' for new easements. No structures including walls allowed in easements.
- Retaining walls 3' and over must be engineered.
- All retaining walls (18" or taller) must be rock or stone face. No smooth concrete walls.
- The property will need to be platted.
- Orient dumpsters so trucks only have to maneuver through site once.

Drainage Items:

- Detention is required. Drainage calculations based on property zoning, not land area use.
- The property owner will be responsible for maintaining, repair, and replacement of the detention/drainage systems.
- The site currently drains to the north underneath of Mims Road. Existing drainage patterns must be maintained.
- No grate inlets allowed.
- Detention systems must be in a drainage easement.
- No vertical walls allowed in detention/drainage easement.
- No public water or sanitary sewer allowed in detention/drainage easements.
- 100-year WSEL must be called out for detention systems.
- FFE for all buildings must be called out when adjacent to detention systems. Minimum 2' above 100-year WSEL.
- Dumpster areas to drain to oil/water separator and then to the storm lines.

Water and Wastewater Items:

- Show existing/proposed utility lines (Water, Sewer, etc.)
- Public sewer to be 8" minimum.
- There is an 8" sewer main on the other side of Mims Road available for use.
- Any water lines must be a minimum of 8", looped, and must be in a 20' wide easement.
- There is a 10" water main on the other side of National Drive available for use.
- Only one "use" off a dead-end line (domestic, irrigation, fire sprinkler, fire hydrant, etc.)
- Min 20' utility easements.
- Sanitary sewer is located on north side of Mims. Crossing must be by bore.
- Sanitary sewer must be connected to City main by a manhole.

Roadway Paving Items:

- Parking to be 20'x9'.
- No dead-end parking allowed without an City approved turnaround.
- Drive isles to be 24' wide.
- Fire lane to have 20' min radius if buildings are less than 30' tall. If any of the buildings are 30' or more, the fire lane will be 30' radius minimum.
- Fire lane to be in a platted easement.
- Build 24' of Mims and dedicate half of ROW (30' from the centerline) as well as build a 5' sidewalk along Mims.
- Driveway spacing on Mims is 200' from National and then 100' after and same for driveways along National

BUILDING INSPECTIONS COMMENTS:

- Oil/water Separator and Grease Trap are to be sized by an Engineer per the 2021 International Plumbing Code and this information will be required to be provided with the Building Permit
- Signage and Irrigation require separate permits from the Building Permit submittal

FIRE DEPARTMENT COMMENTS:

- FDC shall be facing and visible from the fire lane.
- FDC must be within 100 feet of a fire hydrant and 50 feet of the fire lane.
- The FDC shall be clear and unobstructed with at least a 5-foot clear all-weather path from the fire lane access.

GIS COMMENTS:

- Addresses will be assigned as:
- BUILDING A: 636 NATIONAL DRIVE, ROCKWALL, TX 75032
- BUILDING B: 628 NATIONAL DRIVE, ROCKWALL, TX 75032
- BUILDING C: 616 NATIONAL DRIVE, ROCKWALL, TX 75032
- BUILDING D: 538 NATIONAL DRIVE, ROCKWALL, TX 75032
- EX. BUILDING: 118 NATIONAL DRIVE will become 526 NATIONAL DRIVE, ROCKWALL, TX 75032
- BUILDING E: 510 NATIONAL DRIVE, ROCKWALL, TX 75032

PARKS DEPARTMENT COMMENTS:

- Winter Boxwoods can be susceptible to freeze damage and loss in this landscape zone with temperatures over last few years. Another great shrubs is the Dwarf Burford Holley and either is approved, just a suggestion.

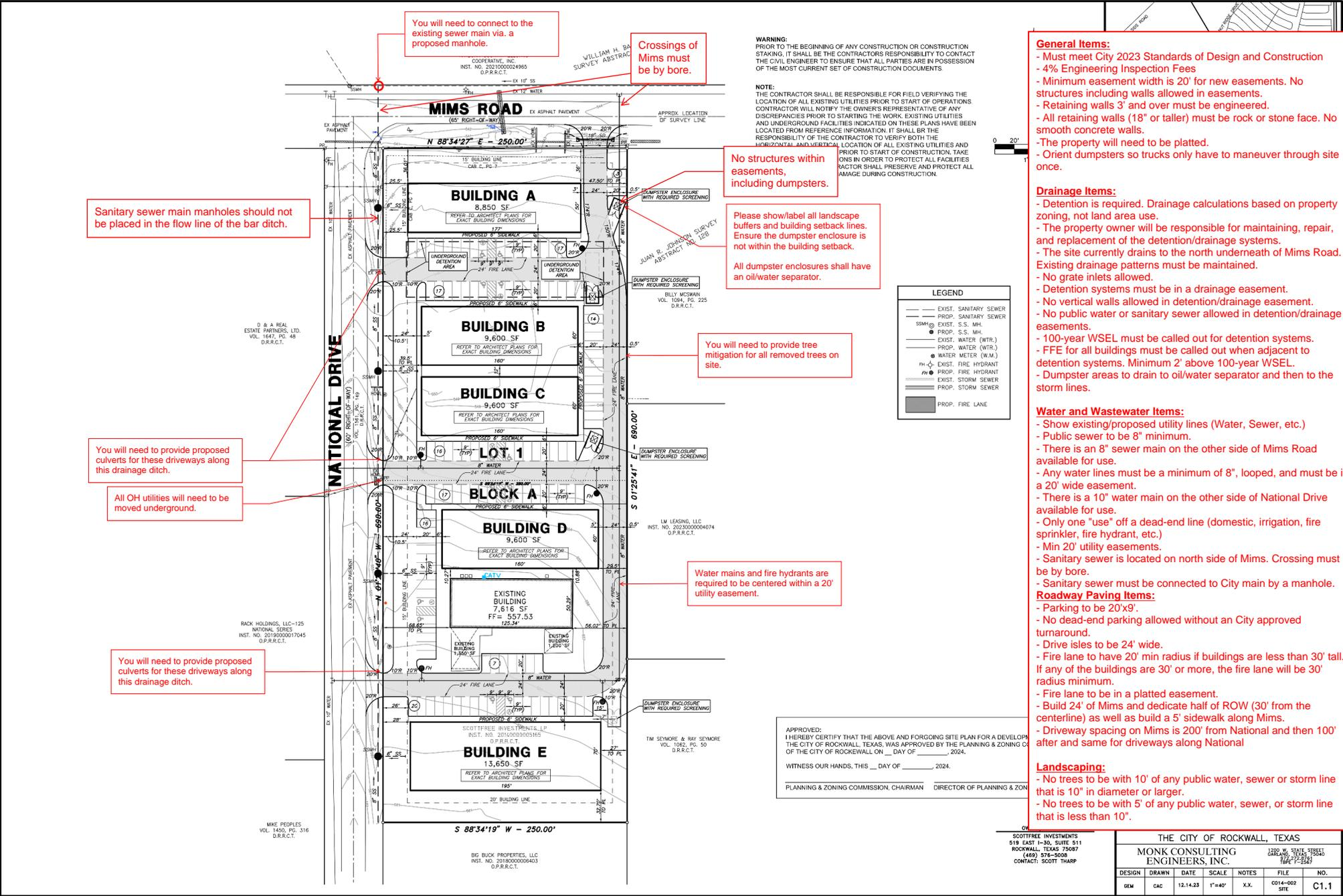

You will need to connect to the existing sewer main via a proposed manhole.

Crossings of Mims must be by bore.

WARNING:
PRIOR TO THE BEGINNING OF ANY CONSTRUCTION OR CONSTRUCTION STAKING, IT SHALL BE THE CONTRACTOR'S RESPONSIBILITY TO CONTACT THE CIVIL ENGINEER TO ENSURE THAT ALL PARTIES ARE IN POSSESSION OF THE MOST CURRENT SET OF CONSTRUCTION DOCUMENTS.

NOTE:
THE CONTRACTOR SHALL BE RESPONSIBLE FOR FIELD VERIFYING THE LOCATION OF ALL EXISTING UTILITIES PRIOR TO START OF OPERATIONS. CONTRACTOR WILL NOTIFY THE OWNER'S REPRESENTATIVE OF ANY DISCREPANCIES PRIOR TO STARTING THE WORK. EXISTING UTILITIES AND UNDERGROUND FACILITIES INDICATED ON THESE PLANS HAVE BEEN LOCATED FROM REFERENCE INFORMATION. IT SHALL BE THE RESPONSIBILITY OF THE CONTRACTOR TO VERIFY BOTH THE HORIZONTAL AND VERTICAL LOCATION OF ALL EXISTING UTILITIES AND PRIOR TO START OF CONSTRUCTION, TAKE ONS IN ORDER TO PROTECT ALL FACILITIES. CONTRACTOR SHALL PRESERVE AND PROTECT ALL DAMAGE DURING CONSTRUCTION.

- General Items:**
- Must meet City 2023 Standards of Design and Construction
 - 4% Engineering Inspection Fees
 - Minimum easement width is 20' for new easements. No structures including walls allowed in easements.
 - Retaining walls 3' and over must be engineered.
 - All retaining walls (18" or taller) must be rock or stone face. No smooth concrete walls.
 - The property will need to be platted.
 - Orient dumpsters so trucks only have to maneuver through site once.

Sanitary sewer main manholes should not be placed in the flow line of the bar ditch.

No structures within easements, including dumpsters.

Please show/label all landscape buffers and building setback lines. Ensure the dumpster enclosure is not within the building setback.

All dumpster enclosures shall have an oil/water separator.

You will need to provide tree mitigation for all removed trees on site.

LEGEND	
---	EXIST. SANITARY SEWER
---	PROP. SANITARY SEWER
SSM@	EXIST. S.S. MH.
●	PROP. S.S. MH.
---	EXIST. WATER (WTR.)
---	PROP. WATER (WTR.)
---	EXIST. WATER (W.M.)
---	PROP. WATER (W.M.)
PH	EXIST. FIRE HYDRANT
PH	PROP. FIRE HYDRANT
---	EXIST. STORM SEWER
---	PROP. STORM SEWER
---	PROP. FIRE LANE

You will need to provide proposed culverts for these driveways along this drainage ditch.

All OH utilities will need to be moved underground.

Water mains and fire hydrants are required to be centered within a 20' utility easement.

You will need to provide proposed culverts for these driveways along this drainage ditch.

- Drainage Items:**
- Detention is required. Drainage calculations based on property zoning, not land area use.
 - The property owner will be responsible for maintaining, repair and replacement of the detention/drainage systems.
 - The site currently drains to the north underneath of Mims Road. Existing drainage patterns must be maintained.
 - No grate inlets allowed.
 - Detention systems must be in a drainage easement.
 - No vertical walls allowed in detention/drainage easement.
 - No public water or sanitary sewer allowed in detention/drainage easements.
 - 100-year WSEL must be called out for detention systems.
 - FFE for all buildings must be called out when adjacent to detention systems. Minimum 2' above 100-year WSEL.
 - Dumpster areas to drain to oil/water separator and then to the storm lines.

- Water and Wastewater Items:**
- Show existing/proposed utility lines (Water, Sewer, etc.)
 - Public sewer to be 8" minimum.
 - There is an 8" sewer main on the other side of Mims Road available for use.
 - Any water lines must be a minimum of 8", looped, and must be in a 20' wide easement.
 - There is a 10" water main on the other side of National Drive available for use.
 - Only one "use" off a dead-end line (domestic, irrigation, fire sprinkler, fire hydrant, etc.)
 - Min 20' utility easements.
 - Sanitary sewer is located on north side of Mims. Crossing must be by bore.
 - Sanitary sewer must be connected to City main by a manhole.

- Roadway Paving Items:**
- Parking to be 20'x9'.
 - No dead-end parking allowed without an City approved turnaround.
 - Drive isles to be 24' wide.
 - Fire lane to have 20' min radius if buildings are less than 30' tall. If any of the buildings are 30' or more, the fire lane will be 30' radius minimum.
 - Fire lane to be in a platted easement.
 - Build 24' of Mims and dedicate half of ROW (30' from the centerline) as well as build a 5' sidewalk along Mims.
 - Driveway spacing on Mims is 200' from National and then 100' after and same for driveways along National

- Landscaping:**
- No trees to be with 10' of any public water, sewer or storm line that is 10" in diameter or larger.
 - No trees to be with 5' of any public water, sewer, or storm line that is less than 10".

APPROVED:
I HEREBY CERTIFY THAT THE ABOVE AND FOREGOING SITE PLAN FOR A DEVELOPMENT OF THE CITY OF ROCKWALL, TEXAS, WAS APPROVED BY THE PLANNING & ZONING COMMISSION OF THE CITY OF ROCKWALL ON ___ DAY OF ____, 2024.
WITNESS OUR HANDS, THIS ___ DAY OF ____, 2024.
PLANNING & ZONING COMMISSION, CHAIRMAN DIRECTOR OF PLANNING & ZONING

SCOTT FREE INVESTMENTS
519 EAST I-30, SUITE 511
ROCKWALL, TEXAS 75087
(469) 578-5006
CONTACT: SCOTT THARP

THE CITY OF ROCKWALL, TEXAS					
MONK CONSULTING ENGINEERS, INC.			1200 W. STATE STREET CAROLINA, TEXAS 75040 (972) 272-2781		
DESIGN	DRAWN	DATE	SCALE	NOTES	FILE NO.
DEM	CAC	12.14.23	1"=40'	X.X.	C014-002 SITE C1.1

BIG BUCK PROPERTIES, LLC
INST. NO. 2018000005463
O.P.R.R.C.T.

MIKE PEOPLES
VOL. 1450, PG. 316
D.P.R.R.C.T.

RACK HOLDINGS, LLC-125
NATIONAL SERIES
INST. NO. 2019000017045
O.P.R.R.C.T.

LM LEASING, LLC
INST. NO. 2023000004074
O.P.R.R.C.T.

TM SMOORE & RAY SMOORE
VOL. 1062, PG. 20
D.P.R.R.C.T.

BILLY MCSWAIN
VOL. 1084, PG. 225
D.P.R.R.C.T.

JUAN R. JOHNSON SURVEY
ABS TRACT NO. 128

WILLIAM H. BA
SURVEY ABSTRACT

COOPERATIVE, INC.
INST. NO. 2021000024965
O.P.R.R.C.T.

D & A REAL
ESTATE PARTNERS, LTD.
VOL. 1647, PG. 48
D.P.R.R.C.T.



DEVELOPMENT APPLICATION

City of Rockwall
Planning and Zoning Department
385 S. Goliad Street
Rockwall, Texas 75087

STAFF USE ONLY

PLANNING & ZONING CASE NO.

SP2023-05

NOTE: THE APPLICATION IS NOT CONSIDERED ACCEPTED BY THE CITY UNTIL THE PLANNING DIRECTOR AND CITY ENGINEER HAVE SIGNED BELOW.

DIRECTOR OF PLANNING:

CITY ENGINEER:

PLEASE CHECK THE APPROPRIATE BOX BELOW TO INDICATE THE TYPE OF DEVELOPMENT REQUEST [SELECT ONLY ONE BOX]:

PLATTING APPLICATION FEES:

- MASTER PLAT (\$100.00 + \$15.00 ACRE) ¹
- PRELIMINARY PLAT (\$200.00 + \$15.00 ACRE) ¹
- FINAL PLAT (\$300.00 + \$20.00 ACRE) ¹
- REPLAT (\$300.00 + \$20.00 ACRE) ¹
- AMENDING OR MINOR PLAT (\$150.00)
- PLAT REINSTATEMENT REQUEST (\$100.00)

SITE PLAN APPLICATION FEES:

- SITE PLAN (\$250.00 + \$20.00 ACRE) ¹
- AMENDED SITE PLAN/ELEVATIONS/LANDSCAPING PLAN (\$100.00)

ZONING APPLICATION FEES:

- ZONING CHANGE (\$200.00 + \$15.00 ACRE) ¹
- SPECIFIC USE PERMIT (\$200.00 + \$15.00 ACRE) ^{1&2}
- PD DEVELOPMENT PLANS (\$200.00 + \$15.00 ACRE) ¹

OTHER APPLICATION FEES:

- TREE REMOVAL (\$75.00)
- VARIANCE REQUEST/SPECIAL EXCEPTIONS (\$100.00) ²

NOTES:

¹: IN DETERMINING THE FEE, PLEASE USE THE EXACT ACREAGE WHEN MULTIPLYING BY THE PER ACRE AMOUNT. FOR REQUESTS ON LESS THAN ONE ACRE, ROUND UP TO ONE (1) ACRE.
²: A \$1,000.00 FEE WILL BE ADDED TO THE APPLICATION FEE FOR ANY REQUEST THAT INVOLVES CONSTRUCTION WITHOUT OR NOT IN COMPLIANCE TO AN APPROVED BUILDING PERMIT.

PROPERTY INFORMATION [PLEASE PRINT]

ADDRESS 626 NATIONAL DR.

SUBDIVISION

LOT

1

BLOCK

A

GENERAL LOCATION

SEC MIMS RD. & NATIONAL DR

ZONING, SITE PLAN AND PLATTING INFORMATION [PLEASE PRINT]

CURRENT ZONING

HC HEAVY COMM.

CURRENT USE

WAREHOUSE

PROPOSED ZONING

SAME

PROPOSED USE

WAREHOUSE

ACREAGE

3.9 AC.

LOTS [CURRENT]

2

LOTS [PROPOSED]

1

SITE PLANS AND PLATS: BY CHECKING THIS BOX YOU ACKNOWLEDGE THAT DUE TO THE PASSAGE OF HB3167 THE CITY NO LONGER HAS FLEXIBILITY WITH REGARD TO ITS APPROVAL PROCESS, AND FAILURE TO ADDRESS ANY OF STAFF'S COMMENTS BY THE DATE PROVIDED ON THE DEVELOPMENT CALENDAR WILL RESULT IN THE DENIAL OF YOUR CASE.

OWNER/APPLICANT/AGENT INFORMATION [PLEASE PRINT/CHECK THE PRIMARY CONTACT/ORIGINAL SIGNATURES ARE REQUIRED]

OWNER

SCOTT FREE INVESTMENTS

APPLICANT

CARROLL ARCHITECTS

CONTACT PERSON

SCOTT THARP

CONTACT PERSON

JEFF CARROLL

ADDRESS

519 E. INTERSTATE 30
SUITE 511

ADDRESS

750 E. INTERSTATE 30
SUITE 110

CITY, STATE & ZIP

ROCKWALL, TX. 75087

CITY, STATE & ZIP

ROCKWALL TX 75087

PHONE

469-576-5008

PHONE

214-632-1762

E-MAIL

SCOTT@SCOTTFREEINV.COM

E-MAIL

JCARROLLARCH.COM

NOTARY VERIFICATION [REQUIRED]

BEFORE ME, THE UNDERSIGNED AUTHORITY, ON THIS DAY PERSONALLY APPEARED Scott Tharp [OWNER] THE UNDERSIGNED, WHO STATED THE INFORMATION ON THIS APPLICATION TO BE TRUE AND CERTIFIED THE FOLLOWING:

I HEREBY CERTIFY THAT I AM THE OWNER FOR THE PURPOSE OF THIS APPLICATION; ALL INFORMATION SUBMITTED HEREIN IS TRUE AND CORRECT; AND THE APPLICATION FEE OF \$ _____ TO COVER THE COST OF THIS APPLICATION, HAS BEEN PAID TO THE CITY OF ROCKWALL ON THIS THE _____ DAY OF _____ 20____. BY SIGNING THIS APPLICATION, I AGREE THAT THE CITY OF ROCKWALL (I.E. "CITY") IS AUTHORIZED AND PERMITTED TO PROVIDE INFORMATION CONTAINED WITHIN THIS APPLICATION TO THE PUBLIC. THE CITY IS ALSO AUTHORIZED AND PERMITTED TO REPRODUCE ANY COPYRIGHTED INFORMATION SUBMITTED IN CONJUNCTION WITH THIS APPLICATION, IF SUCH REPRODUCTION IS ASSOCIATED OR IN RESPONSE TO A REQUEST FOR PUBLIC INFORMATION.

GIVEN UNDER MY HAND AND SEAL OF OFFICE ON THIS THE 14 DAY OF December, 2023

OWNER'S SIGNATURE

Scott Tharp

NOTARY PUBLIC IN AND FOR THE STATE OF TEXAS

Shannan A Sage

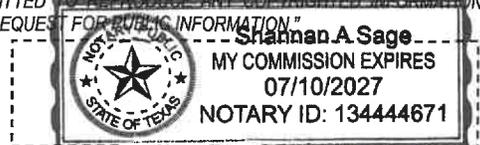

MY COMMISSION EXPIRES

07/10/2027



SP2023-051: Site Plan for Tharp Industrial Park

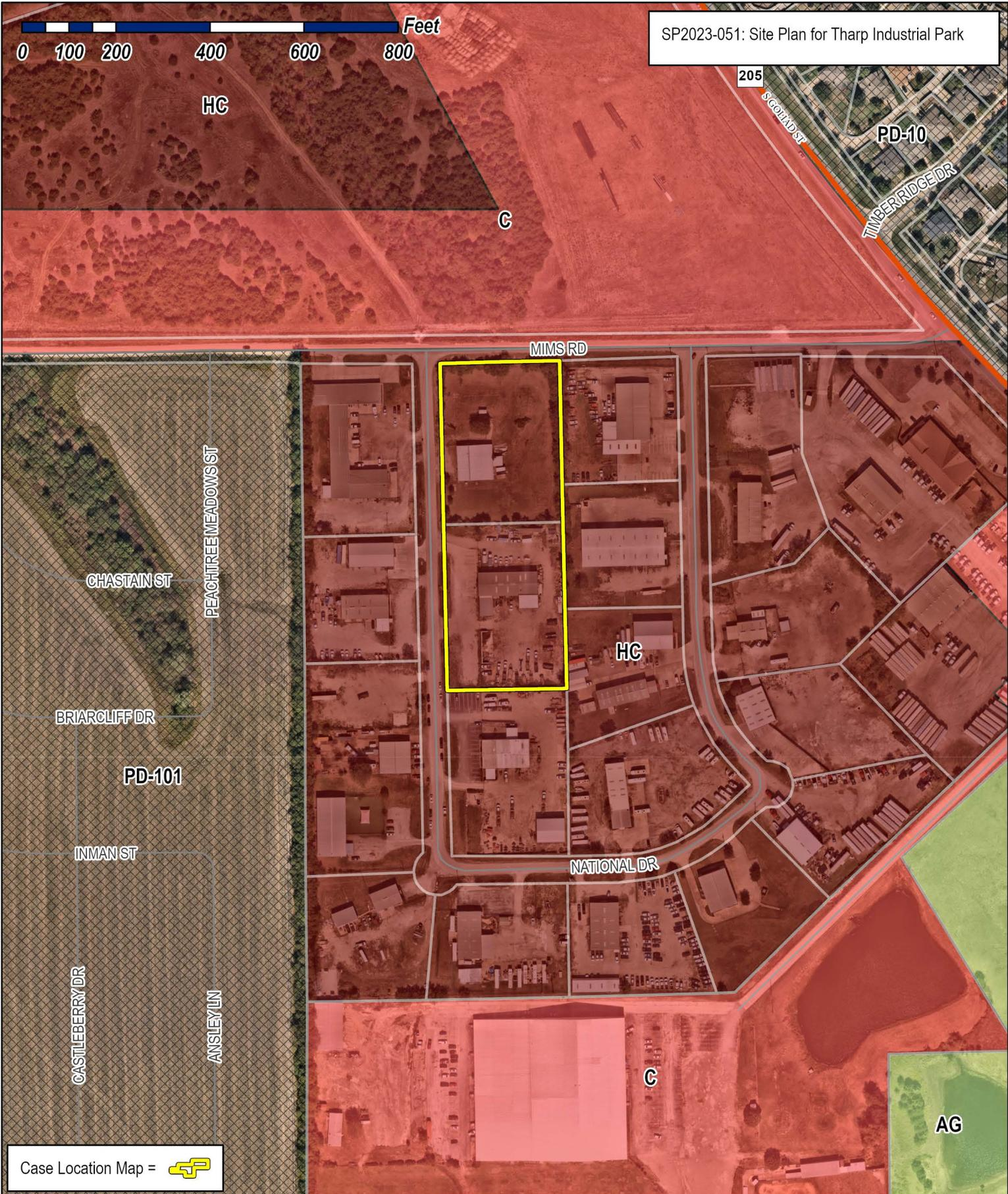

City of Rockwall

Planning & Zoning Department
 385 S. Goliad Street
 Rockwall, Texas 75087
 (P): (972) 771-7745
 (W): www.rockwall.com

The City of Rockwall GIS maps are continually under development and therefore subject to change without notice. While we endeavor to provide timely and accurate information, we make no guarantees. The City of Rockwall makes no warranty, express or implied, including warranties of merchantability and fitness for a particular purpose. Use of the information is the sole responsibility of the user.



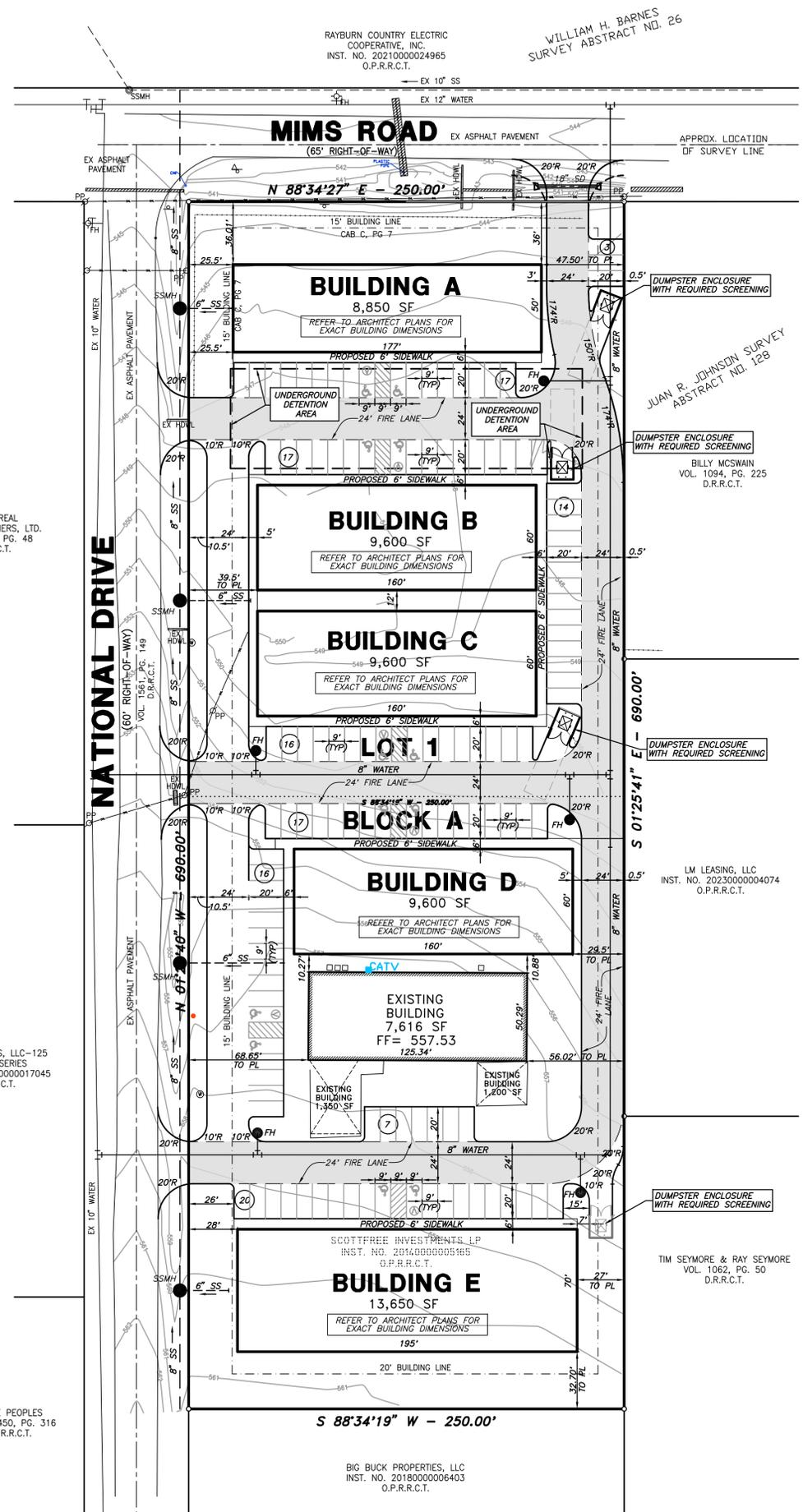

D & A REAL ESTATE PARTNERS, LTD.
VOL. 1647, PG. 48
D.R.R.C.T.

RACK HOLDINGS, LLC-125 NATIONAL SERIES
INST. NO. 20190000017045
O.P.R.R.C.T.

MIKE PEOPLES
VOL. 1450, PG. 316
D.R.R.C.T.

BIG BUCK PROPERTIES, LLC
INST. NO. 2018000006403
O.P.R.R.C.T.

LM LEASING, LLC
INST. NO. 2023000004074
O.P.R.R.C.T.

TIM SEYMORE & RAY SEYMORE
VOL. 1062, PG. 50
D.R.R.C.T.

WARNING:
PRIOR TO THE BEGINNING OF ANY CONSTRUCTION OR CONSTRUCTION STAKING, IT SHALL BE THE CONTRACTORS RESPONSIBILITY TO CONTACT THE CIVIL ENGINEER TO ENSURE THAT ALL PARTIES ARE IN POSSESSION OF THE MOST CURRENT SET OF CONSTRUCTION DOCUMENTS.

NOTE:
THE CONTRACTOR SHALL BE RESPONSIBLE FOR FIELD VERIFYING THE LOCATION OF ALL EXISTING UTILITIES PRIOR TO START OF OPERATIONS. CONTRACTOR WILL NOTIFY THE OWNER'S REPRESENTATIVE OF ANY DISCREPANCIES PRIOR TO STARTING THE WORK. EXISTING UTILITIES AND UNDERGROUND FACILITIES INDICATED ON THESE PLANS HAVE BEEN LOCATED FROM REFERENCE INFORMATION. IT SHALL BE THE RESPONSIBILITY OF THE CONTRACTOR TO VERIFY BOTH THE HORIZONTAL AND VERTICAL LOCATION OF ALL EXISTING UTILITIES AND UNDERGROUND FACILITIES PRIOR TO START OF CONSTRUCTION. TAKE THE NECESSARY PRECAUTIONS IN ORDER TO PROTECT ALL FACILITIES ENCOUNTERED. THE CONTRACTOR SHALL PRESERVE AND PROTECT ALL EXISTING UTILITIES FROM DAMAGE DURING CONSTRUCTION.

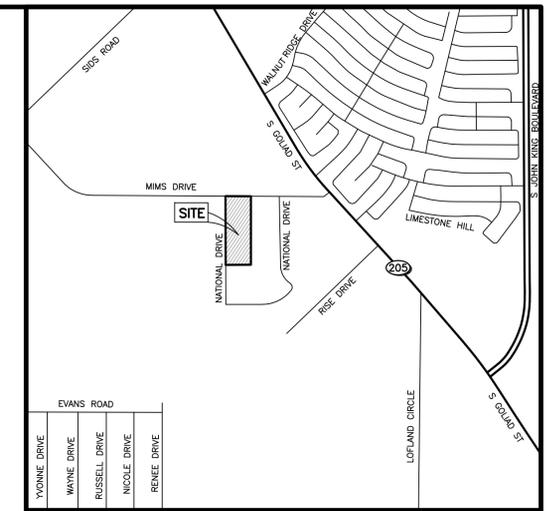
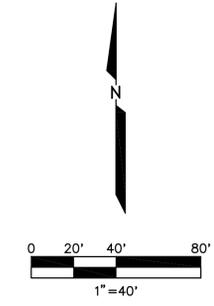

LEGEND

- EXIST. SANITARY SEWER
- PROP. SANITARY SEWER
- SSMH @ EXIST. S.S. MH.
- PROP. S.S. MH.
- EXIST. WATER (WTR.)
- PROP. WATER (WTR.)
- ⊙ WATER METER (W.M.)
- FH @ EXIST. FIRE HYDRANT
- FH ● PROP. FIRE HYDRANT
- EXIST. STORM SEWER
- PROP. STORM SEWER
- PROP. FIRE LANE

SITE DATA

LOT AREA:	3,960 ACRES (172,500 SQ. FT.)
ZONING:	HC (HEAVY COMMERCIAL)
CURRENT USE:	RETAIL/OUTSIDE STORAGE
PROPOSED USE:	OFFICE/WAREHOUSE
BUILDING AREA:	
PROPOSED:	60,300 SQ. FT.
OFFICE:	6 TENANTS/ BLDG. @ 600 SF EACH x 5 BLDGS. = 18,000 SF
WAREHOUSE:	58,910 SQ. FT.
MEZZANINE:	300 SF PER TENANT PER BLDG (300x6x5) = 9,000 SF
EXISTING:	7,616 SQ. FT.
TOTAL BUILDING AREA:	67,910 SQ. FT.
MAX. BUILDING HEIGHT:	0 FEET
FLOOR/AREA RATIO:	0.39
PARKING REQUIRED:	118 SPACES (6 HC SPACES)
OFFICE:	62 (1/300 SQ. FT.)
WAREHOUSE:	41 SPACES (1/1,000 SQ. FT.)
MEZZANINE:	9 SPACES (1/1,000 SQ. FT.)
PARKING PROVIDED:	127 SPACES (12 HC SPACES)
PARKING RATIO:	1.87/1,000 SQ. FT.
IMPERVIOUS AREA:	132,997 SQ. FT.

LAYOUT & DIMENSION CONTROL GENERAL NOTES

- BOUNDARY SURVEY:** BOUNDARY SURVEY INFORMATION IS BASED ON THE BOUNDARY SURVEY PREPARED BY CBG PLANNING & SURVEYING.
- PROPERTY LINES AND EASEMENTS:** REFER TO THE BOUNDARY SURVEY AND PLAT TO VERIFY PROPERTY LINES AND EASEMENT LOCATIONS.
- DIMENSION CONTROL:** ALL PAVING DIMENSIONS AND COORDINATES SHOWN ARE TO FACE OF CURB, UNLESS NOTED OTHERWISE.
- CURB RADII:** ALL CURB RADII SHALL BE 3' AT FACE OF CURB, UNLESS NOTED OTHERWISE.
- BUILDING DIMENSIONS:** THE CONTRACTOR SHALL REFER TO THE ARCHITECT PLANS TO VERIFY THE EXACT BUILDING DIMENSIONS.
- BUILDING ORIENTATION:** THE BUILDING IS PARALLEL AND PERPENDICULAR TO THE EAST PROPERTY LINE - S 01°24'11" E.

PRELIMINARY FOR REVIEW ONLY

THESE DOCUMENTS ARE FOR REVIEW ONLY AND NOT INTENDED FOR CONSTRUCTION, BIDDING, OR PERMITTING. THEY HAVE BEEN PREPARED BY OR UNDER THE SUPERVISION OF GERALD E. MONK, P.E.

P.E. NO.: 44563
DATE: 12/13/2023

APPROVED:
I HEREBY CERTIFY THAT THE ABOVE AND FORGOING SITE PLAN FOR A DEVELOPMENT IN THE CITY OF ROCKWALL, TEXAS, WAS APPROVED BY THE PLANNING & ZONING COMMISSION OF THE CITY OF ROCKWALL ON ___ DAY OF ____, 2024.

WITNESS OUR HANDS, THIS ___ DAY OF ____, 2024.

PLANNING & ZONING COMMISSION, CHAIRMAN

DIRECTOR OF PLANNING & ZONING

OWNER/DEVELOPER
SCOTTFREE INVESTMENTS
519 EAST I-30, SUITE 511
ROCKWALL, TEXAS 75087
(469) 576-5008
CONTACT: SCOTT THARP

PROJECT #: SP2024-__

REV.	DATE	REMARKS

OVERALL SITE PLAN

THARP INDUSTRIAL PARK
SEC MIMS ROAD & NATIONAL DRIVE
THE CITY OF ROCKWALL, TEXAS

MONK CONSULTING ENGINEERS, INC.
1200 W. STATE STREET
GARLAND, TEXAS 75040
972-272-8761
TBPE F-2567

DESIGN	DRAWN	DATE	SCALE	NOTES	FILE	NO.
GEM	CAC	12.14.23	1"=40'	X.X.	C014-002 SITE	C1.1

EXTERIOR FINISH SCHEDULE	
A	PREFINISHED METAL ROOFING R-PANELS COLOR: DARK CHARCOAL
B	PREFINISHED WALL R-PANELS COLOR: SMOKESTACK GRAY
C	PREFINISHED GUTTER, DOWNSPOUTS, OR TRIM COLOR: DARK CHARCOAL
D	EXTERIOR FRAME, PAINT, COLOR: DARK CHARCOAL
E	PREFINISHED METAL SECTIONAL OVERHEAD DOORS, COLOR: CHARCOAL
F	GLAZING: DOUBLE PANE INSULATED, LOW E GLASS W/ WINDOW TINTED GRAY @ 10%
G	STOREFRONT ENTRY DOOR SYSTEM: ALUM. COLOR - CHARCOAL
H	PREFINISHED METAL AWNING BY METAL BUILDING CO. COLOR - CHARCOAL
J	STONE, ROUGH FACE, COLOR - SONOMA CREAM SHADOW GRAY MORTAR/SEALANT - BASE, COLOR - TAN
K	CAST STONE CAP - TO MATCH STONE COLOR

ISSUE:	
OWNER REVIEW:	12-15-2023

COPYRIGHT NOTICE:
 All drawings are the property of CARROLL architects and shall remain the property of CARROLL architects. No part of these drawings may be reproduced, stored in a retrieval system, or transmitted in any form or by any means, electronic, mechanical, photocopying, recording, or by any information storage and retrieval system, without the prior written permission of CARROLL architects. The protection of this drawing is governed by the Copyright Act of 1976. As amended January 2002. The protection of this drawing is governed by the Copyright Act of 1976. Under such protection, unauthorized use or reproduction of these drawings may result in criminal or civil penalties, including building seizure, and/or monetary liability.

NOTE: PROVIDE CONCRETE SPLASH BLOCKS AT ALL DOWNSPOUT SURFACE WATER

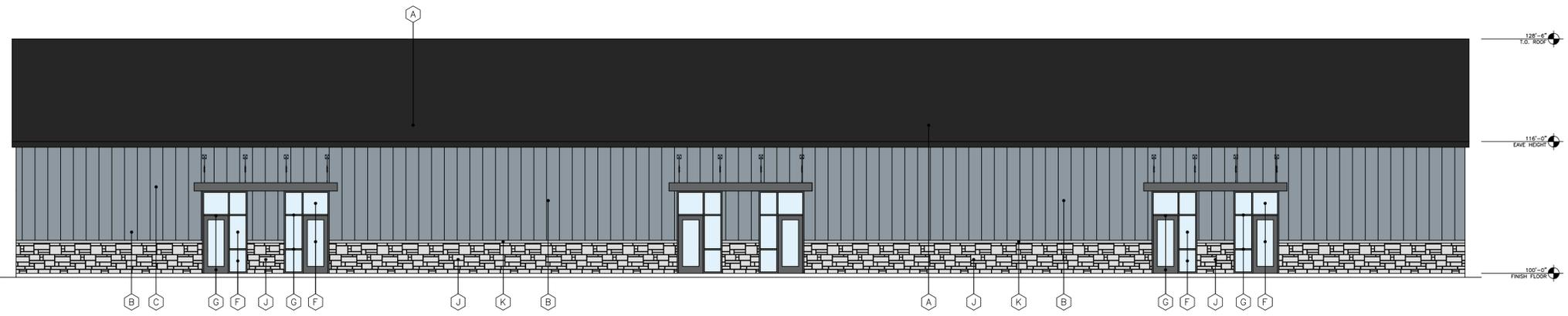

4 REAR ELEVATION
SCALE: 1/8"=1'-0"

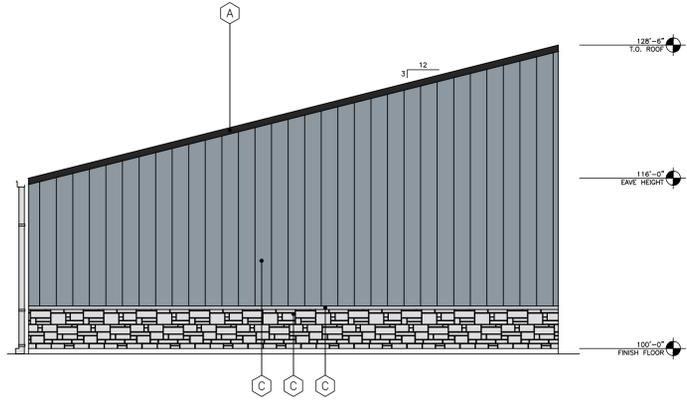

3 RIGHT ELEVATION
SCALE: 1/8"=1'-0"

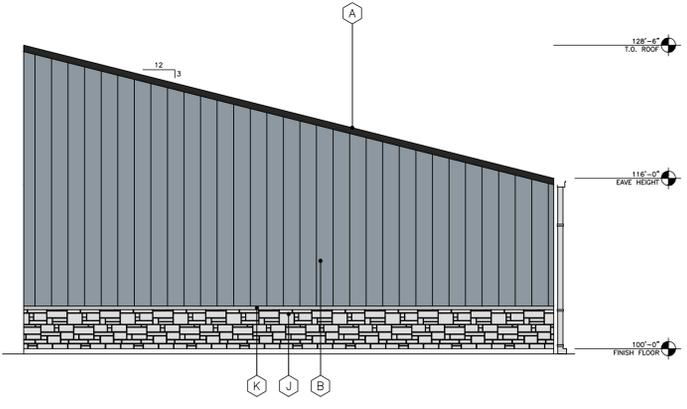

2 RIGHT ELEVATION
SCALE: 1/8"=1'-0"



1 FRONT ELEVATION
SCALE: 1/8"=1'-0"

OFFICE WAREHOUSE BUILDING A
626 NATIONAL DRIVE
ROCKWALL, TX



750 E. Interstate 30
 Suite 110
 Rockwall, TX 75087
 t: 972-732-6085
 f: 972-732-8058

EXTERIOR ELEVATIONS BUILDING A

DATE:	MAR 2023	SHEET NO.:	
PROJECT NO.:	2023010		
DRAWN BY:	KR		
CHECKED BY:			

A501

